



Swansea University
Prifysgol Abertawe



Cronfa - Swansea University Open Access Repository

This is an author produced version of a paper published in:
Accident Analysis & Prevention

Cronfa URL for this paper:
<http://cronfa.swan.ac.uk/Record/cronfa50030>

Paper:

Beck, B., Chong, D., Olivier, J., Perkins, M., Tsay, A., Rushford, A., Li, L., Cameron, P., Fry, R. et. al. (2019). How much space do drivers provide when passing cyclists? Understanding the impact of motor vehicle and infrastructure characteristics on passing distance. *Accident Analysis & Prevention*
<http://dx.doi.org/10.1016/j.aap.2019.03.007>

This item is brought to you by Swansea University. Any person downloading material is agreeing to abide by the terms of the repository licence. Copies of full text items may be used or reproduced in any format or medium, without prior permission for personal research or study, educational or non-commercial purposes only. The copyright for any work remains with the original author unless otherwise specified. The full-text must not be sold in any format or medium without the formal permission of the copyright holder.

Permission for multiple reproductions should be obtained from the original author.

Authors are personally responsible for adhering to copyright and publisher restrictions when uploading content to the repository.

<http://www.swansea.ac.uk/library/researchsupport/ris-support/>

31 **ABSTRACT:**

32 **Background:** Understanding factors that influence the distance that drivers provide when passing
33 cyclists is critical to reducing subjective risk and improving cycling participation. This study aimed to
34 quantify passing distance and assess the impact of motor vehicle and road infrastructure
35 characteristics on passing distance.

36 **Methods:** An on-road observational study was conducted in Victoria, Australia. Participants had a
37 custom device installed on their bicycle and rode as per their usual cycling for one to two weeks. A
38 hierarchical linear model was used to investigate the relationship between motor vehicle and
39 infrastructure characteristics (location, presence of on-road marked bicycle lane and the presence of
40 parked cars on the kerbside) and passing distance (defined as the lateral distance between the end
41 of the bicycle handlebars and the passing motor vehicle).

42 **Results:** Sixty cyclists recorded 18,527 passing events over 422 trips. The median passing distance
43 was 173cm (Q1: 137cm, Q3: 224cm) and 1,085 (5.9%) passing events were less than 100cm. Relative
44 to sedans, 4WDs had a reduced mean passing distance of 15cm (Q1: 12cm, Q3: 17cm) and buses had
45 a reduced mean passing distance of 28cm (Q1: 16cm, Q3: 40cm). Relative to passing events that
46 occurred on roads without a marked bicycle lane and without parked cars, passing events on roads
47 with a bike lane with no parked cars had a reduced mean passing distance of 27cm (Q1: 25cm, Q3:
48 29cm), and passing events on roads with a bike lane and parked cars had a mean lower passing
49 distance of 40cm (Q1: 37cm, Q3: 43cm).

50 **Conclusions:** One in every 17 passing events was a close (<100cm) passing event. We identified that
51 on-road bicycle lanes and parked cars reduced passing distance. These data can be used to inform
52 the selection and design of cycling-related infrastructure and road use with the aim of improving
53 safety for cyclists.

54

55 **INTRODUCTION**

56 Cycling as an active mode of transport has numerous health, environmental and social benefits.¹⁻³
57 For example, commuting by bicycle is associated with a 41% lower risk of all-cause mortality and
58 45% lower risk of cancer incidence.² However, cycling injuries are on the rise⁴ and a large proportion
59 of these involve collisions with motor vehicles.⁵

60 To increase participation, there is a need to address key barriers to cycling. Prior studies have noted
61 that traffic conditions and motor vehicles driving closely to cyclists heighten subjective risk and
62 create a barrier to cycling participation.⁶⁻⁹ Therefore, quantifying how close motor vehicles pass
63 cyclists and identifying the characteristics of close passing events provides an opportunity to develop
64 interventions that address key barriers to increased cycling participation. Prior studies of passing
65 distance have typically been conducted using a single instrumented bicycle on a set route,¹⁰⁻¹³ using
66 data collected only on a single cyclist,¹⁴ or have used a limited number of fixed traffic cameras to
67 estimate passing distance,¹⁵ thus limiting the generalisability of these findings. Naturalistic driving
68 studies have also been used to study the lateral distance that vehicles provide when passing cyclists,
69 but have been limited to a small number of passing events,¹⁶ or have used surrogate measures of
70 passing distance, such as the distance to the bicycle lane marking, rather than quantifying lateral
71 passing distance.¹⁷ Using a device that can be fitted to any bicycle and enabling cyclists to self-select
72 their route may alleviate some of the limitations of prior studies. To address this knowledge gap, we
73 developed a purpose-built, on-bike device that measures the distance that motor vehicles provide
74 when passing cyclists. Using this technology, this study aimed to quantify passing distance and
75 assess the impact of motor vehicle and road infrastructure characteristics on passing distance.

76

77 **METHODS**

78 **Study design**

79 An on-road observational study was conducted in Victoria, Australia. A screening survey was used to
80 identify potential participants. Eligible participants provided consent to be involved in the study, had
81 a custom device installed on their bicycle and rode as per their usual cycling for one to two weeks.
82 Data collection occurred between April and August 2017.

83 **Ethics**

84 Ethical approval for the study was obtained from the Monash University Human Research Ethics
85 Committee (CF16/2348 – 2016001181).

86 **Inclusion criteria**

87 A screening survey was used to identify eligible participants. The screening survey was promoted
88 through Monash University social media accounts. The screening survey asked about age, sex,
89 bicycle type, cycling experience, percentage of a usual ride spent on-road, number of times riding a
90 bicycle per week, purpose of the majority of riding and geographical region. Based on this
91 information, purposive sampling was used to recruit cyclists who rode mostly on-road (>60% of an
92 average trip), were located in metropolitan Melbourne (and distributed across metropolitan
93 Melbourne) and rode more than two times per week.

94 **Quantifying passing distance**

95 A purpose-built, on-bike device was developed for the purposes of this study. This device, named the
96 MetreBox, utilised the following technology: Arduino microprocessor (Adafruit Feather M0
97 Adalogger); Global Positioning System (GPS) sensor (Adafruit Ultimate GPS FeatherWing) that
98 recorded at 1 Hz; ultrasonic sensor (XL-MaxSonar-EZ3 MB1230, Maxbotix, Minnesota, USA) that
99 recorded at 10 Hz; and lithium ion 18650 hard case battery with voltage protection (Core
100 Electronics).

101 A custom designed hard case was created with a 3D printer. The device was charged using a micro
102 USB cable and data were stored on a micro SD card. Validation of the ultrasonic sensor was

103 performed using a flat wall and each MetreBox was tested at 100cm and 200cm ranges, accuracy of
104 each individual sensor varied. Each MetreBox was individually tested and calibrated, resulting in a
105 measurement accuracy of +/- 1.5cm. The device had a measurement range of 0cm to 330cm.

106 ***Device installation***

107 Device installation was performed by a study research assistant. The MetreBox device was installed
108 on each participant's own bicycle under the saddle and a forward facing GoPro Hero 5 Session
109 (GoPro, California, USA) was mounted on the handlebars (Figure 1). Each participant was provided
110 with a detailed user guide and was responsible for activating both the MetreBox and GoPro camera
111 at the start of each ride. Both devices recorded constantly. The study research assistant measured
112 the width of the handlebars. The end of the handlebar was deemed to be the widest point on the
113 bicycle. Consistent with prior studies,^{18,19} the passing distance was calculated as the distance from
114 the end of the handlebars to the passing motor vehicle.

115 **Procedures**

116 ***Defining passing event***

117 A passing event was deemed to occur when a motor vehicle passed a cyclist within the recordable
118 range of the MetreBox device. Thus, events in which a cyclist undertook a motor vehicle were
119 excluded. Additionally, events in which a cyclist passed another cyclist were excluded. As per
120 legislation in most Australian jurisdictions,²⁰ a 'close' passing event was deemed to be an event with
121 a passing distance less than one metre. In Australia, vehicles drive on the left and hence, in this
122 study, we have quantified passing events occurring to the right of the cyclist.

123 ***Coding passing events***

124 A manual review of all recorded events was undertaken by two coders who were trained prior to the
125 commencement of coding. This review was firstly used to exclude passing events that were not
126 motor vehicles or events in which a cyclist undertook a motor vehicle. Secondly, characteristics of

127 each event were classified. These characteristics were defined *a priori* using the Cycling Aspects of
128 Austroads Guide²¹ as a reference. These were:

- 129 • Vehicle type (sedan, taxi, four-wheel drive (4WD), truck, bus, motorcycle, other)
- 130 • Location (mid-block, intersection, roundabout)
- 131 • On-road marked bicycle lane (present, absent)
- 132 • Parked cars on the kerbside (present, absent)

133 An on-road marked bicycle lane was coded when there was a marked dedicated space for cyclists. A
134 random selection of ten rides were independently coded by two coders and the inter-rater reliability
135 was assessed (see Statistical analyses below).

136 ***Map matching, speed zones and road types***

137 To be able to map known locations of passing events to speed zone data, GPS data were aligned to
138 road network maps (OpenStreetMap, OpenStreetMap contributors, 2015. Retrieved from
139 <https://planet.openstreetmap.org>). This was achieved using a probabilistic map matching approach
140 and implemented in Python using the ST-matching method.^{22,23} Speed zone data were obtained from
141 VicRoads' open source shapefile available on data.vic.gov.au.²⁴

142 To quantify the distance that cyclists travelled on-road (and were therefore exposed to motor
143 vehicles), GPS traces were map matched to the OpenStreetMap road and cycle network maps using
144 Python and a modified version of the Open Source Routing Machine (OSRM; [http://project-
145 osrm.org/](http://project-osrm.org/)) Map Matching service. OpenStreetMap road classifications were used to classify
146 segments that were on-road (e.g. 'motorway', 'primary', 'residential') and segments that were off-
147 road (e.g. 'cycleway', 'path').

148 **Statistical analyses**

149 Agreement between coders was assessed using percentage of agreement and Cohen's kappa (κ)
150 statistic,²⁵ with κ scores interpreted as fair ($\kappa=0.21-0.40$), moderate ($\kappa=0.41-0.60$), substantial

151 ($\kappa=0.61-0.80$) and almost perfect ($\kappa=0.81-1.00$).²⁶ Data were summarised using frequencies and
152 percentages for categorical variables and mean and standard deviation (SD) or median and lower
153 (Q1) and upper (Q3) quartiles for continuous variables. A hierarchical linear model was used to
154 investigate the relationship between motor vehicle and infrastructure characteristics and passing
155 distance. Characteristics were modelled as fixed effects. A random intercept and random slope were
156 applied for each rider, with each trip nested within the rider. The correlation type assumed was
157 AR(1), meaning that successive passing distances within the same trip were assumed to be
158 correlated. The hierarchical linear modelling was performed by a statistician (author: J.O.), who was
159 blinded to all variables with the exception of speed zone. As the presence of a marked on-road
160 bicycle lane and the presence of parked cars were highly related, these two variables were modelled
161 as an interaction. To evaluate the addition of other interaction terms, we ran fixed effects models
162 using maximum likelihood to compare various levels of interaction terms (saturated model, 3-way,
163 2-way and no interaction). Akaike and Bayesian information criteria demonstrated our chosen
164 model fitted the data the best while the likelihood ratio test also preferred this model after adjusting
165 for multiple testing. Speed zone was missing in 7.3% ($n=1350$) of passing events and vehicle type was
166 missing in 0.01% ($n=23$) of passing events and these events were excluded from the hierarchical
167 linear model. Additional hierarchical linear models were used to quantify the average distance
168 participants travelled per trip, the average number of passing events per 10 km travelled and the
169 average number of passing events less than 100cm per 10 km travelled. Data are reported as
170 averages with 95% confidence intervals (CI).

171 Two sensitivity analyses were conducted. Firstly, the impact of excluding cases with missing speed
172 zone ($n=1350$) was evaluated. A chi-square goodness of fit test was used to compare the average
173 passing distance when the model included and excluded speed zone (observations with missing
174 speed zone were excluded from both models). Secondly, we investigated the relationship between
175 motor vehicle and infrastructure characteristics and passing distance relative to legislated passing
176 distances in other regions of Australia. Legalisation or trials of minimum passing distances have been

177 legislated in other regions of Australia and stipulate that drivers must provide a passing distance of
178 at least 1 metre when the speed limit is 60 km/h or less, and 1.5 metres when the speed limit is
179 more than 60 km/h.²⁷ Therefore, in this sensitivity analysis, we centred passing distance at 1 metre
180 in speed zones of 60 km/h or less and 1.5 metres in speed zones of greater than 60 km/h. Negative
181 and positive values of passing distance were therefore relative to these recommended passing
182 distances. A chi-square goodness of fit test was used to compare this model with the main model
183 with passing distance as an absolute value.

184 Data analysis was performed using Stata (Version 14.2, StataCorp, College Station, TX) and SAS
185 (Version 9.4, SAS Institute Inc., Cary, NC, USA). The importance of a variable was assessed by its p-
186 value and effect size.

187

188 **RESULTS**

189 Sixty-three participants consented to participate. Of these, complete data were available for 60
190 participants (two participants were not able to activate the device and one participant did not ride
191 during the data collection period). The participants with complete data had a median age of 39.3
192 years (Q1: 32.0 years, Q3: 48.5 years) and 75% (n=45) were male. A total of 422 trips were recorded,
193 with a mean of 7 trips per participant (SD: 3.14). Participants rode a total of 5,302 km, of which
194 4,831 km (91%) was classified as on-road. The average trip distance was 12.6 km (95% CI: 11.9, 13.3)
195 of which the average distance ridden on-road per trip was 11.5 km (95% CI: 10.9, 12.1).

196 A total of 18,527 passing events were recorded with a median passing distance of 173 cm (Q1:
197 137cm, Q3: 224cm; range: 24cm – 330cm). Participants recorded an average of 28.0 passing events
198 per 10 km travelled (95% CI: 25.8, 30.4). Of these, 0.7% were less than 60cm, 1.4% between 60 and
199 79cm and 3.8% between 80 and 99cm (Table 1). Overall, 1,085 (5.9%) passing events were less than
200 100cm. Participants recorded an average of 1.7 passing events less than 100cm per 10 km travelled

201 (95% CI: 1.5, 1.9). For passing events in speed zones of 60 km/h or less (n=16,274; 95%), the
202 proportion of passing events less than 100cm was 5.9% (n=952). For passing events in speed zones
203 of greater than 60 km/h (n=903; 5%), the proportion of passing events less than 150cm was 32%
204 (n=293). Between-subject variation was noted for mean passing distances and for the proportion of
205 passing events less than 100cm. Mean passing distances varied between cyclists from 147cm to
206 230cm (Figure 2). The mean proportion of passing events less than 100cm varied between cyclists
207 from 0.9% to 29.9% (Figure 3).

208 Most passing events involved sedans (70.4%) or 4WDs (17.2%), occurred mid-block (89.8%),
209 occurred in the absence of a marked on-road bicycle lane (57.6%), in the absence of parked cars on
210 the kerbside (83.0%) and in speed zones of 50 km/h (22.6%) or 60 km/h (61.0%) (Table 1). Figures 5-
211 8 provide unadjusted differences in passing distances for each characteristic. The proportion of
212 passing events <100cm was greater when the cyclist was riding in a marked on-road bicycle lane
213 relative to a road without a bike lane (6.8% vs 5.1%; P<0.001).

214 Results from the hierarchical linear model are shown in Table 2. Relative to sedans, 4WDs had a
215 mean lower passing distance of 15cm (Q1: 12cm, Q3: 17cm) and buses had a reduced mean passing
216 distance of 28cm (Q1: 16cm, Q3: 40cm). Relative to passing events that occurred on roads without a
217 marked bicycle lane and without parked cars, passing events on roads with a bike lane with no
218 parked cars had a reduced mean passing distance of 27cm (Q1: 25cm, Q3: 29cm), and passing events
219 on roads with a bike lane and parked cars had a reduced mean passing distance of 40cm (Q1: 37cm,
220 Q3: 43cm) (Figure 9). Passing events that occurred on roads without a marked bicycle lane and
221 without parked cars had a lower estimated proportion of passing events <100cm (5%) compared to
222 passing events that occurred on roads with a bike lane and parked cars (9%). There were no notable
223 differences between locations or speed zones.

224 **Sensitivity analyses**

225 In a sensitivity analysis comparing the primary model with a model that included all variables with
226 the exception of speed zone (and included all cases), there were no significant differences in model
227 coefficients ($\chi^2=1.302$; $df=12$; $P>0.99$). Similarly, in a sensitivity analysis comparing the primary
228 model with a model with passing distance centred around 1 metre in speed zones of 60 km/h or less
229 and 1.5 metres in speed zones of greater than 60 km/h, there were no significant differences in
230 model coefficients ($\chi^2=0.046$; $df=18$; $P>0.99$).

231 **Inter-rater reliability**

232 There were 558 passing events that were independently coded by two coders. 513 (92%) were
233 coded by both coders and 45 (8%) were coded by only one coder. There was almost perfect
234 agreement for location ($\kappa = 0.88$; 95% CI: 0.82, 0.94), bike lane ($\kappa = 0.82$; 95% CI: 0.77, 0.87) and the
235 presence of parked cars ($\kappa = 0.84$; 95% CI: 0.77, 0.90), and substantial agreement for vehicle type (κ
236 = 0.69; 95% CI: 0.62, 0.76). The most frequent disagreement for vehicle type was sedan and 4WD
237 (percentage agreement = 42%).

238

239 **DISCUSSION**

240 We quantified the distance that motor vehicles provide when passing cyclists and investigated the
241 impact of motor vehicle and road infrastructure characteristics on passing distance. In a sample of
242 18,527 passing events, approximately one in every 17 passing events was a 'close' pass (<100cm). In
243 higher speed zones, over 60kph, one in every three passing events was a 'close' pass (<150m). We
244 noted important links between motor vehicle types and infrastructure characteristics, and passing
245 distance. These data demonstrate that road infrastructure is associated with passing distance and
246 can be used to inform the selection and design of cycling-related infrastructure.

247 Previous studies that have quantified the passing distance that motor vehicles provide to cyclists
248 have commonly used an instrumented bicycle on a set route,¹⁰⁻¹³ or have used a limited number of

249 fixed traffic cameras to estimate passing distance.¹⁵ To our knowledge, our study is the first study to
250 use technology mounted on cyclists' own bicycles to quantify passing distance with cyclists riding on
251 self-selected routes. Furthermore, the number of passing events in our study (n=18,527) is
252 substantially larger than that previously reported (e.g. n=145,¹¹ n=1380,¹² n=1846¹⁵; see Table 3). In
253 the current study, we observed a mean passing distance of 173cm. This is slightly lower than data
254 from another Australian state, Queensland, in which a mean passing distance of 186cm was
255 reported,¹⁵ and 6.4 ft (195cm) reported in Wisconsin, United States.¹³ In contrast to our study, both
256 of these prior studies were conducted in settings with legislated bicycle passing distance rules.

257 Data on the effectiveness of marked on-road bicycle lanes in reducing crashes are limited. Some
258 studies have suggested that bicycle lanes offer reduced crash risk,²⁸⁻³⁰ while others have suggested
259 that they offer no benefit.³¹ The findings of the current study indicate that passing distance was
260 reduced when the cyclist was riding in a marked on-road bicycle lane, and this is supported by a
261 study from the United Kingdom that reported a reduced passing distance of between 7cm and
262 18cm.¹⁰ In addition, we observed a greater rate of close passing events when the cyclist was riding
263 on a road with a marked bicycle lane (6.8% vs 5.1%). It has been suggested that this is a result of
264 driver perceptions. Specifically, in situations where the cyclist is in the same lane as the motorist, the
265 driver is required to perform an overtaking manoeuvre (i.e. change lanes to pass). Whereas, in
266 situations where the cyclist is in a dedicated marked bicycle lane, the motorist has a clear lane ahead
267 and is not required to perform an overtaking manoeuvre.¹⁰ As a result, there is less of a conscious
268 requirement for drivers to provide additional passing distance.

269 Road lane width has also been identified as an important factor with increased lane widths having
270 been shown to facilitate greater passing distances.¹⁸ Furthermore, lane widths may also explain
271 some of the variation in passing distance we observed between vehicle types. For example, the
272 reduced passing distance observed with buses, relative to sedans, may be explained by the greater
273 width of buses. We were unable to obtain accurate lane width data across the entire road network

274 of metropolitan Melbourne and thus this is a factor we were unable to control for. Similarly, the
275 number of lanes of traffic in the direction of travel for the cyclist may also influence driver
276 overtaking manoeuvres and hence passing distance. However, these data were also unavailable.
277 The reduction in passing distance when the cyclist was riding in a marked bicycle lane was further
278 exacerbated when parked cars were present. The reduced passing distance in the presence of
279 parked cars may be explained by cyclists' choice of lane position, in that they may be electing to
280 move outside of the 'dooring' zone.³² It has also been shown that cyclist crash odds are higher on
281 roads with parked cars relative to roads without parked cars.³⁰ We noted substantial between-cyclist
282 variation in mean passing distances and the proportion of close passing events. This is suggestive of
283 an influence of rider behaviour or route selection on passing distance. However, further work is
284 required to quantify this.

285 We observed no notable differences in passing distances between speed zones, suggesting that
286 drivers do not adapt the clearance provided to cyclists with speed. In other regions of Australia (with
287 the exception of our region of Victoria), legalisation or trials of minimum passing distances have
288 been legislated and stipulate that drivers must provide a passing distance of at least 1 metre when
289 the speed limit is 60 km/h or less, and 1.5 metres when the speed limit is more than 60 km/h. In line
290 with our finding that passing distance did not differ between speed zones, and consistent with
291 Debnath *et al.* (2018),¹⁵ we observed a higher proportion of passing events in which the passing
292 distance was less than these suggested boundaries in speed zones of greater than 60 km/h. Given
293 that passing vehicle speed is known to be a major concern for cyclists,³³ speed-based minimum
294 passing distance regulations are justified, and our results demonstrate the need to increase
295 education for drivers to provide greater passing distance at higher vehicle speeds.

296 Overall, these findings have important implications for the selection and design of cycling-related
297 infrastructure. Specifically, these findings suggest that marked on-road bicycle lanes, particularly
298 alongside parked cars, are not the optimal solution for maximising motor vehicle passing distance.

299 This begs the question: is a single stripe of white paint enough to protect cyclists? That is not to
300 suggest that we should not provide on-road marked bicycle lanes. Rather, the focus of on-road
301 cycling infrastructure needs to be on providing infrastructure that separates cyclists from motor
302 vehicles by a physical barrier. If this is not possible, then at a minimum, buffer zones should be
303 provided between the edge of the cycle lane and motor vehicle traffic lanes, and, if necessary,
304 between the bicycle lane and parked cars.

305 The proportion of close passing events recorded in this study reflects one close passing event for
306 every 17 motor vehicles that pass. Given that close passing events are a key contributor to reduced
307 perceived safety in cyclists,⁷ it is clear that efforts to reduce close passing events will improve the
308 experience of people cycling on our roads with the aim of increasing cycling participation.

309 The strengths of this study include the use of on-bike technology that enabled the quantification of
310 passing distance while cyclists were using their own bicycles and as part of normal riding. The
311 manual review of all recorded events, while time-consuming, provided a robust and detailed
312 approach to classifying motor vehicle and road infrastructure characteristics, and for confirming
313 motor vehicle passing events (and excluding situations in which a cyclist undertook a motor vehicle).
314 Although some variation was noted between coders. Furthermore, data were collected on cyclists
315 riding in metropolitan Melbourne and therefore these data may not be reflective of cyclists in outer
316 suburbs or regional areas. Additionally, given the frequency of data collection from the ultrasound
317 sensor, it is likely that the sensor detected the motor vehicle body, rather than the side mirrors, and
318 therefore passing distances are likely to be conservative estimates. Additionally, the proportion of
319 passing events less than 100cm is related to the maximal distance that the sensor can read. For
320 example, if the maximal recordable distance is restricted to 300cm, 250cm or 200cm, the proportion
321 of close passing events increases to 6.1%, 7.0% and 8.9%, respectively. A small amount of data were
322 missing for speed zone, which was an artefact of lost GPS signals. However, sensitivity analyses
323 revealed that this did not appreciably impact on model estimates. Further, and as noted above, data

324 were not available on road lane widths, bicycle lane widths or number of lanes and hence we could
325 not control for these factors. Additionally, there were a small number of passing events that could
326 not be coded due to inadequate ambient lighting and these events were excluded from analyses.
327 There is also a need to understand how cyclists' subjective experiences align with quantified passing
328 distances.

329

330 **CONCLUSION**

331 From a large sample of events in which a motor vehicle passed a cyclist, one in every 17 passing
332 events was a close passing event (<100cm) and in higher speed zones (over 60kph), one in every
333 three was a close passing event (<150cm). We identified that road infrastructure had a substantial
334 influence on the distance that motor vehicles provide when passing cyclists. Specifically, we
335 demonstrated that on-road bicycle lanes reduced passing distance. These data can be used to inform
336 the selection and design of cycling-related infrastructure that actually provides a safety benefit for
337 cyclists.

338

339

340 **ACKNOWLEDGEMENTS**

341 The authors would like to acknowledge the contribution of the participants in this study. Carol Chong
342 is thanked for her assistance. Dr Kira Kempinska (University College London) is thanked for her
343 assistance with geospatial analyses.

344

345 **FUNDING**

346 This study was funded by a Transport Accident Commission Community Road Safety Grant and a
347 Monash University Faculty of Medicine, Nursing and Health Sciences Strategic Grant. Ben Beck was
348 supported by an Australian Research Council Discovery Early Career Researcher Award Fellowship
349 (DE180100825). Peter Cameron was supported by a Practitioner Fellowship (#545926) from the
350 National Health and Medical Research Council (NHMRC). Marilyn Johnson was supported by an
351 Australian Research Council Discovery Early Career Researcher Award Fellowship (DE170101180).

352

353 REFERENCES

- 354 1. Teschke K, Reynolds CC, Ries FJ, Gouge B, Winters M. Bicycling: Health risk or benefit. *UBC*
355 *Medical Journal*. 2012;3(2):6-11.
- 356 2. Celis-Morales CA, Lyall DM, Welsh P, et al. Association between active commuting and
357 incident cardiovascular disease, cancer, and mortality: prospective cohort study. *BMJ*.
358 2017;357(j1456).
- 359 3. Mueller N, Rojas-Rueda D, Cole-Hunter T, et al. Health impact assessment of active
360 transportation: a systematic review. *Prev Med*. 2015;76:103-114.
- 361 4. Beck B, Cameron P, Fitzgerald MC, et al. Road safety: serious injuries remain a major
362 unsolved problem. *Med J Aust*. 2017;207(6):244-249.
- 363 5. Beck B, Stevenson M, Newstead S, et al. Bicycling crash characteristics: An in-depth crash
364 investigation study. *Accid Anal Prev*. 2016;96:219-227.
- 365 6. Heesch KC, Sahlqvist S, Garrard J. Gender differences in recreational and transport cycling: a
366 cross-sectional mixed-methods comparison of cycling patterns, motivators, and constraints.
367 *International Journal of Behavioral Nutrition and Physical Activity*. 2012;9(1):106.
- 368 7. Heesch KC, Sahlqvist S, Garrard J. Cyclists' experiences of harassment from motorists:
369 Findings from a survey of cyclists in Queensland, Australia. *Prev Med*. 2011;53(6):417-420.
- 370 8. Chataway ES, Kaplan S, Nielsen TAS, Prato CG. Safety perceptions and reported behavior
371 related to cycling in mixed traffic: A comparison between Brisbane and Copenhagen.
372 *Transportation Research Part F: Traffic Psychology and Behaviour*. 2014;23:32-43.
- 373 9. Foundation CPFatNH. Riding a Bike for Transport: 2011 Survey Findings. 2011;
374 [https://www.heartfoundation.org.au/images/uploads/publications/Cycling-Survey-2011-](https://www.heartfoundation.org.au/images/uploads/publications/Cycling-Survey-2011-Riding-a-Bike-for-Transport.pdf)
375 [Riding-a-Bike-for-Transport.pdf](https://www.heartfoundation.org.au/images/uploads/publications/Cycling-Survey-2011-Riding-a-Bike-for-Transport.pdf). Accessed 13/11/2018.
- 376 10. Parkin J, Meyers C. The effect of cycle lanes on the proximity between motor traffic and
377 cycle traffic. *Accid Anal Prev*. 2010;42(1):159-165.
- 378 11. Dozza M, Schindler R, Bianchi-Piccinini G, Karlsson J. How do drivers overtake cyclists? *Accid*
379 *Anal Prev*. 2016;88:29-36.
- 380 12. Chuang K-H, Hsu C-C, Lai C-H, Doong J-L, Jeng M-C. The use of a quasi-naturalistic riding
381 method to investigate bicyclists' behaviors when motorists pass. *Accid Anal Prev*.
382 2013;56:32-41.
- 383 13. Chapman J, Noyce D. Observations of driver behavior during overtaking of bicycles on rural
384 roads. *Transportation Research Record: Journal of the Transportation Research Board*.
385 2012(2321):38-45.
- 386 14. Walker I. Drivers overtaking bicyclists: Objective data on the effects of riding position,
387 helmet use, vehicle type and apparent gender. *Accid Anal Prev*. 2007;39(2):417-425.
- 388 15. Debnath AK, Haworth N, Schramm A, Heesch KC, Somoray K. Factors influencing
389 noncompliance with bicycle passing distance laws. *Accid Anal Prev*. 2018;115:137-142.
- 390 16. Kovaceva J, Nero G, Bärghman J, Dozza M. Drivers overtaking cyclists in the real-world:
391 Evidence from a naturalistic driving study. *Safety Science*. 2018.
- 392 17. Feng F, Bao S, Hampshire RC, Delp M. Drivers overtaking bicyclists—An examination using
393 naturalistic driving data. *Accid Anal Prev*. 2018;115:98-109.
- 394 18. Love DC, Breaud A, Burns S, Margulies J, Romano M, Lawrence R. Is the three-foot bicycle
395 passing law working in Baltimore, Maryland? *Accid Anal Prev*. 2012;48:451-456.
- 396 19. Walker I, Garrard I, Jowitt F. The influence of a bicycle commuter's appearance on drivers'
397 overtaking proximities: an on-road test of bicyclist stereotypes, high-visibility clothing and
398 safety aids in the United Kingdom. *Accid Anal Prev*. 2014;64:69-77.
- 399 20. Schramm AJ, Haworth NL, Heesch K, Watson A, Debnath AK. *Evaluation of the Queensland*
400 *minimum passing distance road rule*. Brisbane, Australia: Queensland University of
401 Technology;2016.
- 402 21. Austroads. *Cycling Aspects of Austroads Guides*. Sydney, NSW, Australia: Austroads;2017.

- 403 22. Kempinska K, Davies T, Shawe-Taylor J, Longley P. Probabilistic Map-Matching for Low-
404 Frequency GPS Trajectories. Paper presented at: Proceedings of GIS Ostrava2017.
- 405 23. Kempinska K, Davies T, Shawe-Taylor J. Probabilistic map-matching using particle filters.
406 *arXiv preprint arXiv:161109706*. 2016.
- 407 24. VicRoads. Speed Zone Data. 2017; [https://www.data.vic.gov.au/data/dataset/speed-zone-](https://www.data.vic.gov.au/data/dataset/speed-zone-data)
408 [data](https://www.data.vic.gov.au/data/dataset/speed-zone-data). Accessed 01 October 2017.
- 409 25. Viera AJ, Garrett JM. Understanding interobserver agreement: the kappa statistic. *Fam Med*.
410 2005;37(5):360-363.
- 411 26. Landis JR, Koch GG. The measurement of observer agreement for categorical data.
412 *Biometrics*. 1977:159-174.
- 413 27. Amy Gillett Foundation. Amy Gillett Foundaton: A Metre Matters. 2018;
414 <http://www.amygillett.org.au/programs-resources/a-metre-matters>. Accessed 06 Feburary
415 2018.
- 416 28. Reynolds C, Harris MA, Teschke K, Crompton PA, Winters M. The impact of transportation
417 infrastructure on bicycling injuries and crashes: a review of the literature. *Environmental*
418 *Health*. 2009;8(1):47.
- 419 29. Teschke K, Frendo T, Shen H, et al. Bicycling crash circumstances vary by route type: a cross-
420 sectional analysis. *BMC Public Health*. 2014;14(1):1.
- 421 30. Teschke K, Harris MA, Reynolds CC, et al. Route infrastructure and the risk of injuries to
422 bicyclists: a case-crossover study. *Am J Public Health*. 2012;102(12):2336-2343.
- 423 31. Mulvaney C, Smith S, Watson M, et al. Cycling infrastructure for reducing cycling injuries in
424 cyclists. *Cochrane Database of Systematic Reviews 2015*. 2015;12.
- 425 32. Hatfield J, Poulos RG, Rissel C, et al. Factors associated with cyclists' self-reported choice of
426 lane position. *Transportation Research Part F: Traffic Psychology and Behaviour*.
427 2018;55:403-414.
- 428 33. Fishman E, Washington S, Haworth N. Barriers and facilitators to public bicycle scheme use:
429 A qualitative approach. *Transportation Research Part F: Traffic Psychology and Behaviour*.
430 2012;15(6):686-698.
- 431 34. Llorca C, Angel-Domenech A, Agustin-Gomez F, Garcia A. Motor vehicles overtaking cyclists
432 on two-lane rural roads: Analysis on speed and lateral clearance. *Safety Science*.
433 2017;92:302-310.

434

435

436 **TABLES**

437

438 *Table 1: Number of passing events by passing distance, motor vehicle or infrastructure characteristic.*

Characteristic		N (%)	Passing distance Mean (SD)
Passing distance			
	0-59 cm	124 (0.7%)	
	60-79 cm	254 (1.4%)	
	80-99 cm	707 (3.8%)	
	100-119 cm	1528 (8.2%)	
	120-149 cm	3652 (19.7%)	
	150-199 cm	5861 (31.6%)	
	200-249 cm	3305 (17.8%)	
	250 cm and greater	3096 (16.7%)	
Motor vehicle type			
	Sedan	13031 (70.4%)	185 (61)
	Taxi	357 (1.9%)	166 (60)
	4WD	3173 (17.1%)	177 (59)
	Truck	379 (2.0%)	185 (69)
	Bus	86 (0.5%)	161 (71)
	Other	1478 (8.0%)	176 (60)
Location			
	Intersection related	1884 (10.2%)	182 (65)
	Mid-block	16631 (89.8%)	183 (60)
	Roundabout	12 (0.1%)	167 (84)
Presence of a marked on-road bicycle lane			
	No	10674 (57.6%)	196 (65)
	Yes	7853 (42.4%)	164 (49)
Presence of parked cars on the kerbside			
	No	15381 (83.0%)	188 (62)
	Yes	3146 (17.0%)	158 (49)
Speed zone ^a			
	40 km/h or less	1931 (11.2%)	168 (56)
	50 km/h	3873 (22.5%)	170 (57)
	60 km/h	10470 (61.0%)	190 (62)
	70 km/h	345 (2.0%)	189 (62)
	80 km/h	539 (3.1%)	182 (58)
	100 km/h	19 (0.1%)	154 (51)

439 Note: Missing data: a) n=1,350 (7.3%)

440

441

442 *Table 2: Results of the hierarchical linear model investigating the relationship between motor vehicle and infrastructure*
 443 *characteristics, and passing distance (N=17,156). Values represent the difference of least square means.*

Characteristic		Difference in passing distance (Q1, Q3) (cm)
Motor vehicle type		
	Sedan	<i>Reference</i>
	Taxi	- 8 (-14, -2)
	4WD	-15 (-17, -12)
	Truck	-8 (-14, -2)
	Bus	-28 (-40, -16)
	Other	-12 (-15, -9)
Location		
	Intersection related	<i>Reference</i>
	Mid-block	9 (6, 11)
Interaction of bicycle lane and parked cars		
	No bike lane, no parked cars	<i>Reference</i>
	Bike lane, no parked cars	-27 (-29, -25)
	No bike lane + parked cars	-30 (-34, -27)
	Bike lane + parked cars	-40 (-43, -37)
Speed zone		
	40 km/h or less	-8 (-11, -5)
	50 km/h	-5 (-8, -3)
	60 km/h	<i>Reference</i>
	70 km/h	-7 (-14, -1)
	80 km/h	-6 (-12, 0)
	100 km/h	-18 (-43, 7)

444

445

446

447 *Table 3: Summary of prior studies that quantified the lateral passing distance that motor vehicles provide when passing*
 448 *cyclists.*

Study	Number of passing events	Number of riders	Number of trips	Details
Current study	18,527	60	422	Device installed on cyclist's own bicycle
Other studies				
Walker <i>et al.</i> (2014) ¹⁹	5,690	1	67	Instrumented bicycle
Feng <i>et al.</i> (2018) ¹⁷	4,789	Unknown	Unknown	Existing motor vehicle naturalistic driving study
Llorca <i>et al.</i> (2017) ³⁴	2,928	1	7	Instrumented bicycle
Walker (2007) ¹⁴	2,355	1	Unknown	Instrumented bicycle
Debnath <i>et al.</i> (2018) ¹⁵	1,846	Unknown	Unknown	Video observations at 15 sites
Chuang <i>et al.</i> (2013) ¹²	1,380	34	34	Instrumented bicycle
Chapman & Noyce (2012) ¹³	1,151	Unknown	Unknown	Instrumented bicycle
Parkin & Meyers (2010) ¹⁰	843	Unknown	Unknown	Instrumented bicycle
Love <i>et al.</i> (2012) ¹⁸	586	5	34	Video camera mounted on cyclists' own bicycle
Dozza <i>et al.</i> (2016) ¹¹	145	2	Unknown	Instrumented bicycle
Kovaceva <i>et al.</i> (2018) ¹⁶	83	Unknown	Unknown	Existing motor vehicle naturalistic driving study

449

450

451 FIGURES

A



B

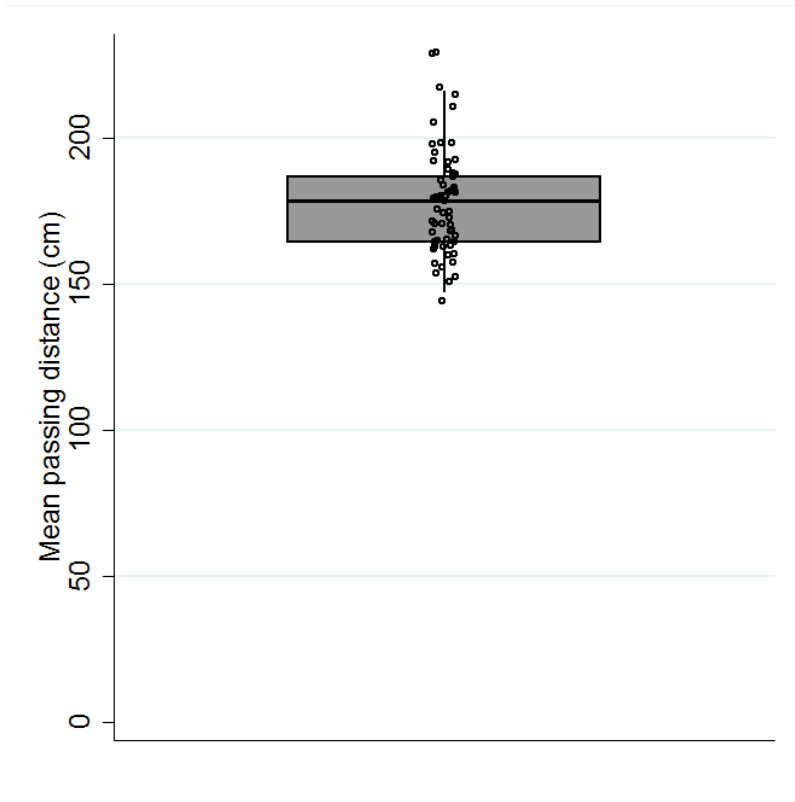

Figure 1: The MetreBox device (A) and the device installed on a bicycle with GoPro camera mounted on handlebars (B).

452

453

454



455

456 *Figure 2: Mean passing distance per participant (markers reflect individual participants).*

457

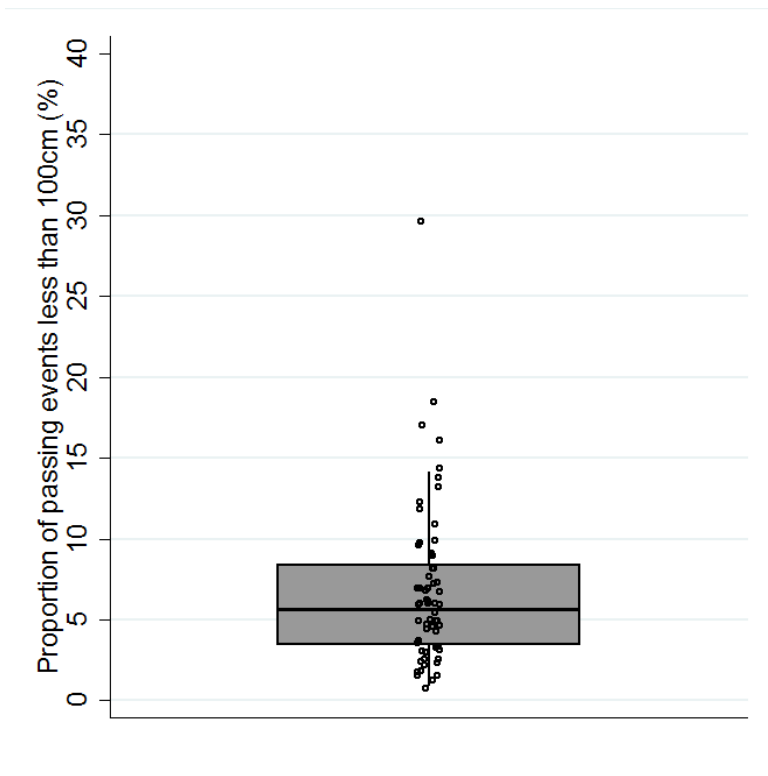

458

459 *Figure 3: Mean proportion of passing events less than 100cm per participant (markers reflect individual participants).*

460

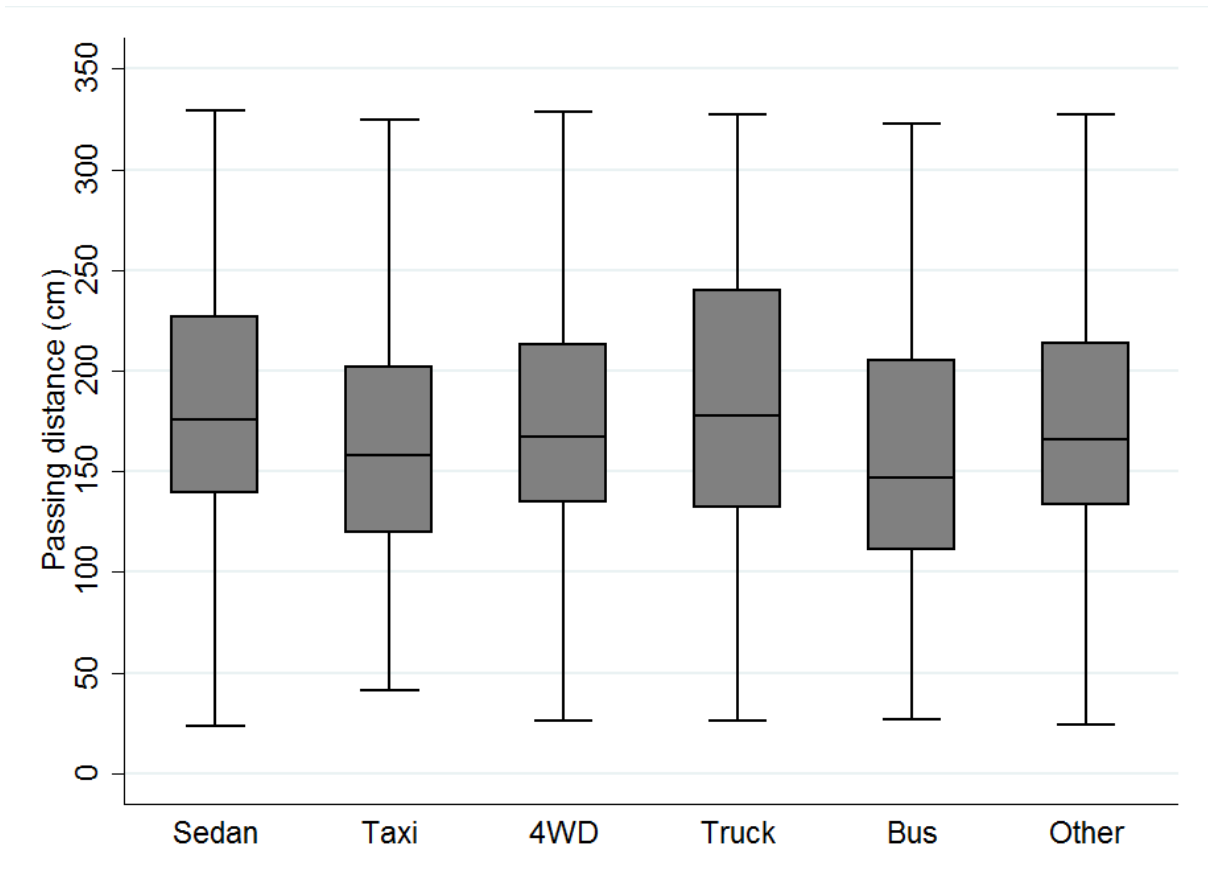

461

462 *Figure 4: Mean passing distance by motor vehicle type.*

463

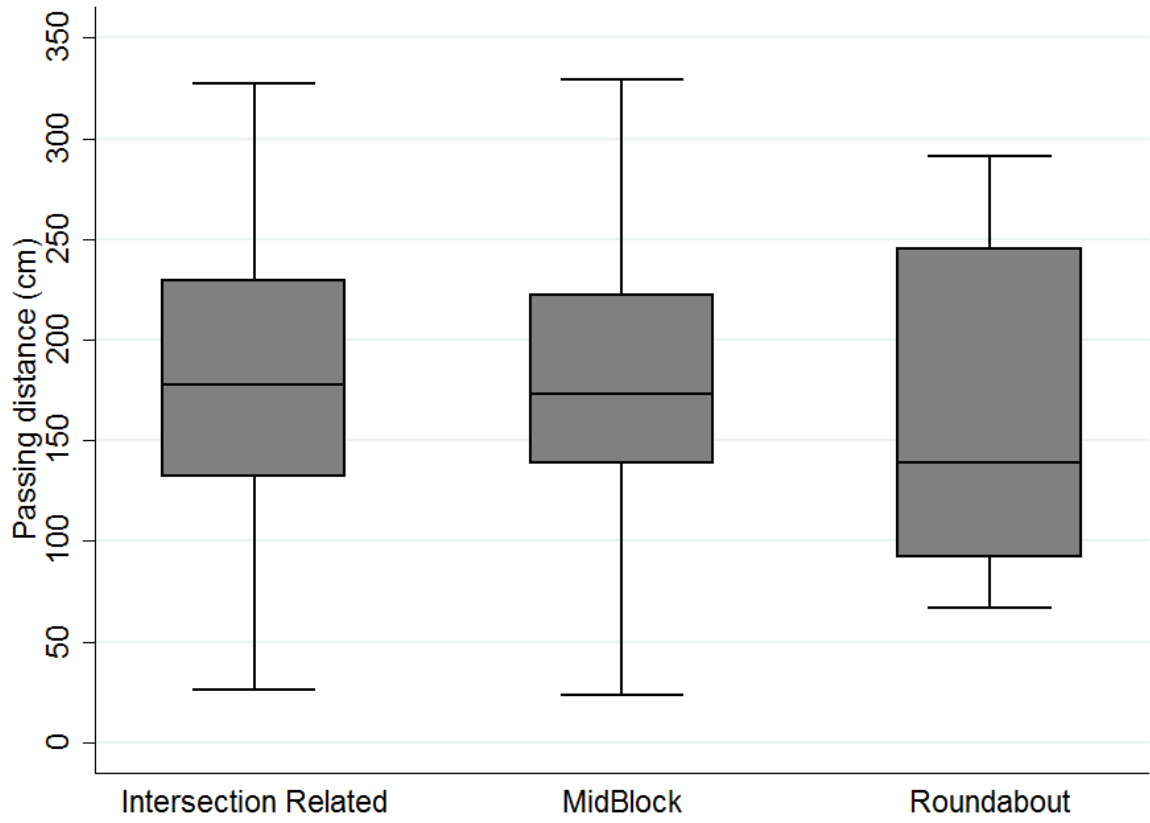

464

465 *Figure 5: Mean passing distance by location.*

466

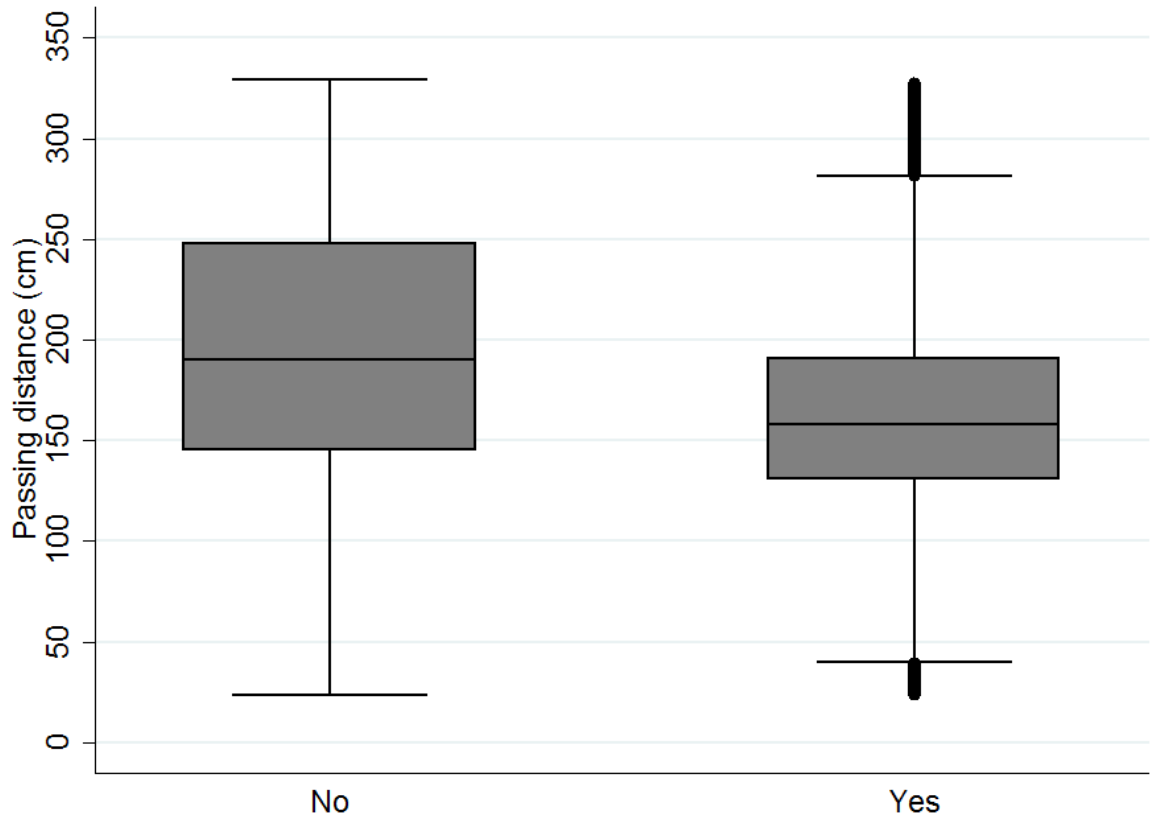

467

468 *Figure 6: Mean passing distance by presence/absence of a marked on-road bicycle lane.*

469

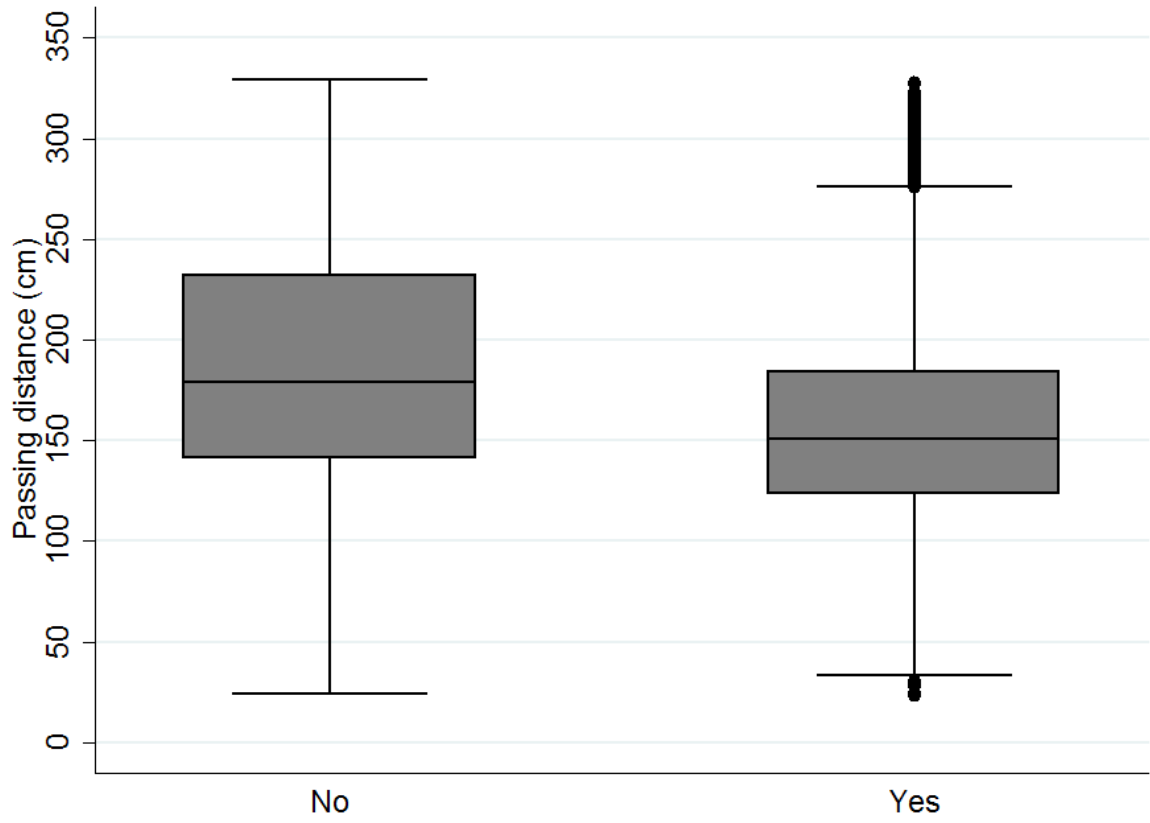

470

471 *Figure 7: Mean passing distance by the presence/absence of parked cars on the kerbside.*

472

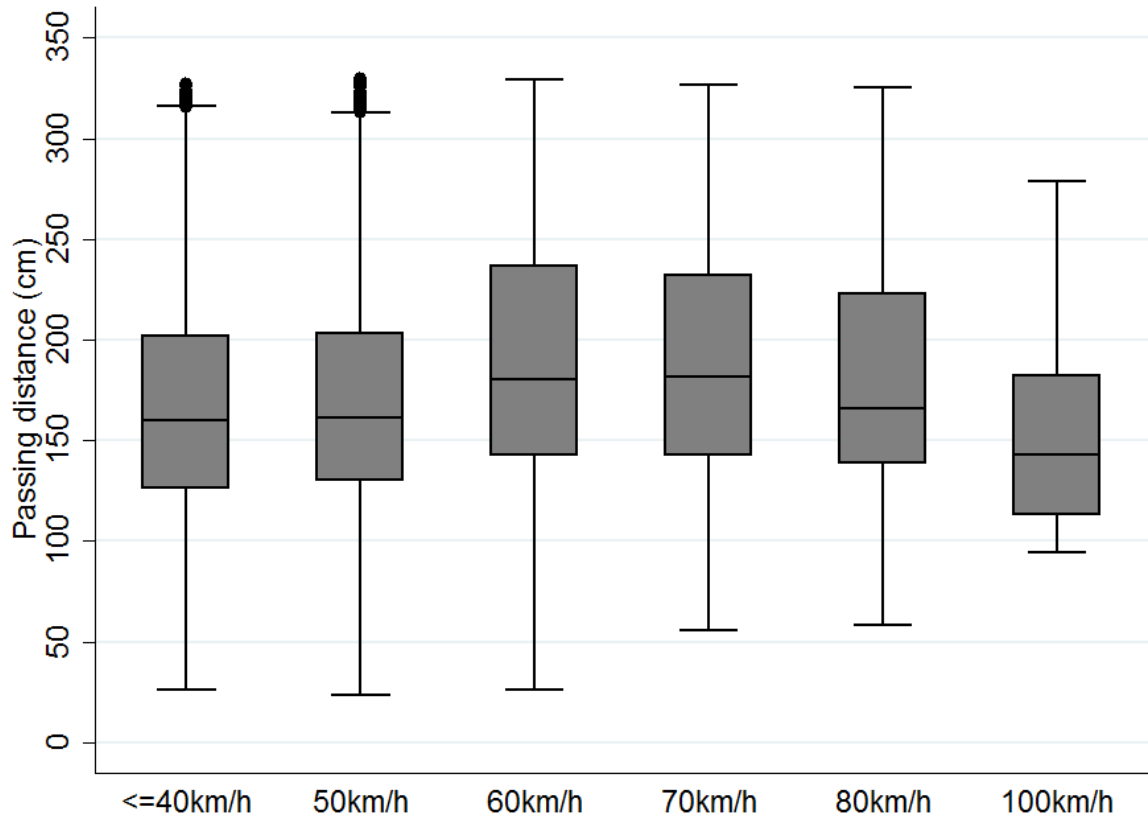

473

474 *Figure 8: Mean passing distance by speed zone.*

475

476

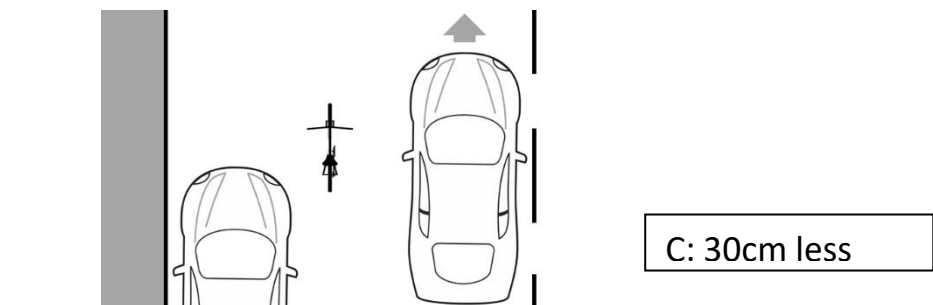
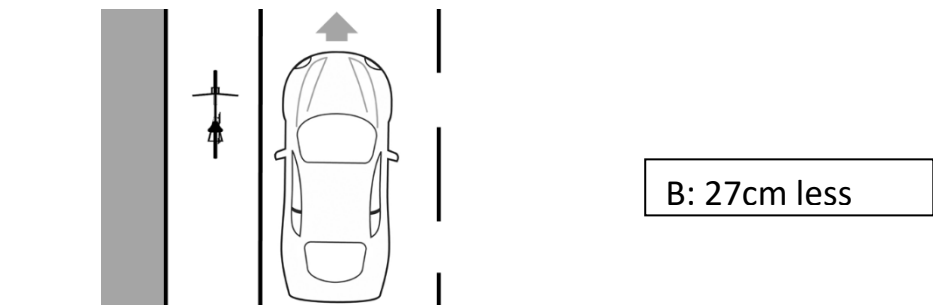
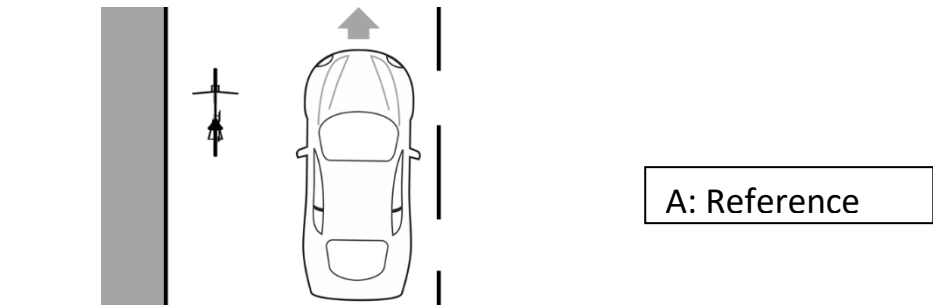

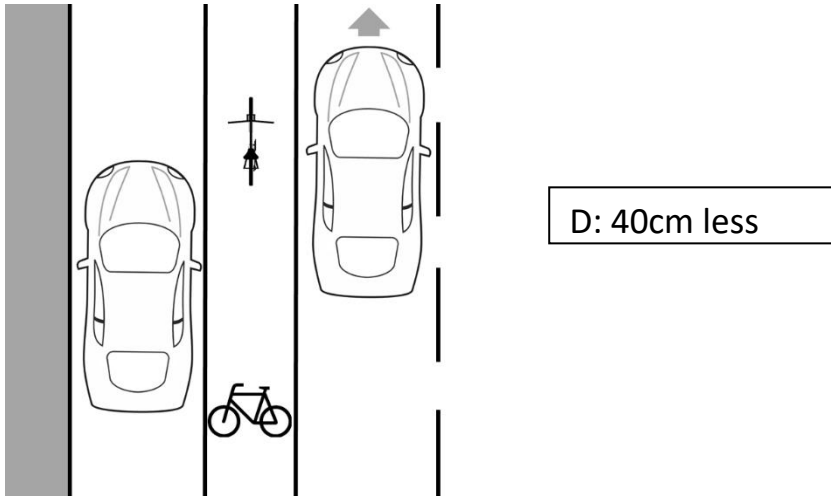

480

481 *Figure 9: Results of hierarchical linear model for the interaction of bicycle lane and parked car on passing distance. Situation*
 482 *A reflects a scenario of no bike lane and no parked cars. Situation B reflects a scenario of a bike lane with no parked cars.*
 483 *Situation C reflects a scenario of no bike lane with parked cars. Situation D reflects a scenario of a bike lane with parked*
 484 *cars.*

485