



Swansea University
Prifysgol Abertawe



Swansea University E-Theses

Novel behavioural and molecular determinants and indicators of attention deficit-/hyperactivity disorder in adults.

Baird, Alison Louise

How to cite:

Baird, Alison Louise (2011) *Novel behavioural and molecular determinants and indicators of attention deficit-/hyperactivity disorder in adults..* thesis, Swansea University.
<http://cronfa.swan.ac.uk/Record/cronfa42973>

Use policy:

This item is brought to you by Swansea University. Any person downloading material is agreeing to abide by the terms of the repository licence: copies of full text items may be used or reproduced in any format or medium, without prior permission for personal research or study, educational or non-commercial purposes only. The copyright for any work remains with the original author unless otherwise specified. The full-text must not be sold in any format or medium without the formal permission of the copyright holder. Permission for multiple reproductions should be obtained from the original author.

Authors are personally responsible for adhering to copyright and publisher restrictions when uploading content to the repository.

Please link to the metadata record in the Swansea University repository, Cronfa (link given in the citation reference above.)

<http://www.swansea.ac.uk/library/researchsupport/ris-support/>

**Novel behavioural and molecular determinants and
indicators of attention
deficit-/hyperactivity disorder in adults**

Alison Louise Baird

*Submitted to Swansea University in fulfilment of the requirements for the degree of
Doctor of Philosophy
Swansea University
2011*

ProQuest Number: 10821363

All rights reserved

INFORMATION TO ALL USERS

The quality of this reproduction is dependent upon the quality of the copy submitted.

In the unlikely event that the author did not send a complete manuscript and there are missing pages, these will be noted. Also, if material had to be removed, a note will indicate the deletion.



ProQuest 10821363

Published by ProQuest LLC (2018). Copyright of the Dissertation is held by the Author.

All rights reserved.

This work is protected against unauthorized copying under Title 17, United States Code
Microform Edition © ProQuest LLC.

ProQuest LLC.
789 East Eisenhower Parkway
P.O. Box 1346
Ann Arbor, MI 48106 – 1346



Summary

Attention deficit-/hyperactivity disorder (ADHD) is a psychiatric condition that can affect both children and adults. It is characterised by behavioural and attention difficulties. Sleep deficits are a prominent characteristic of the disorder and some of the core symptoms of ADHD are known characteristics of sleep deprivation. The circadian clock is integral to determining the rhythm of the sleep/wake cycle. Furthermore the two main forms of pharmacological treatment for ADHD, namely the psychostimulant methylphenidate, and the non-stimulant atomoxetine, along with the targets of these drugs noradrenaline and dopamine, appear to both interact and be under the regulation of the circadian clock.

This thesis aimed firstly to develop a non-invasive technique for the real time RT-PCR quantification of circadian clock gene expression in the human oral mucosa. Secondly to address how circadian clock functioning may be disturbed in adult ADHD via measurement of a number of molecular, endocrine and behavioural markers, for which real-time RT-PCR, ELISA and actigraphy techniques were employed. Thirdly to examine the effects of ADHD medication upon circadian clock protein expression in the rodent brain using immunohistochemistry methods.

Here it is demonstrated that disturbances in the rhythmic secretion of endocrine factors that are key outputs and regulators of the master circadian pacemaker, the circadian clock gene expression of a peripheral oscillator and the actigraphic measures of circadian organization of gross behaviour are associated with adult ADHD. Furthermore, both atomoxetine and methylphenidate are shown to effect circadian clock protein expression. Collectively this data suggests a key role for the circadian clock not only in the pathophysiology of adult ADHD but also indicates a role for pharmacological treatments in the modulation of the circadian clock.

DECLARATION

This work has not previously been accepted in substance for any degree and is not being concurrently submitted in candidature for any degree.

Signed..... (candidate)
Date 11/8/2011.....

STATEMENT 1

This thesis is the result of my own investigations, except where otherwise stated. Where correction services have been used, the extent and nature of the correction is clearly marked in a footnote(s).

Other sources are acknowledged by footnotes giving explicit references. A bibliography is appended.

Signed..... (candidate)
Date 11/8/2011.....

STATEMENT 2

I hereby give consent for my thesis, if accepted, to be available for photocopying and for inter-library loan, and for the title and summary to be made available to outside organisations.

Signed..... (candidate)
Date 11/8/2011.....

Contents

Summary

Declarations

	Page
Acknowledgements	1
Figure and table legends	2-10
Abbreviations	11-14

Chapter 1: Introduction 15-62

1.1 Introduction to the Circadian Clock	16-34
1.2 Circadian Rhythms in Psychiatry	34-43
1.3 Introduction to Attention deficit-/hyperactivity disorder (ADHD)	44-52
1.4 Circadian rhythms and sleep in ADHD	52-59
1.5 The effects of ADHD medication upon sleep and the circadian clock	60-62

Chapter 2: The development of a non-invasive technique for the assaying of human circadian clock function 63-100

2.1 Introduction	64-67
2.2 Methods	68-72
2.3 Results	73-94
2.3.1 Actigraphy and Chronotype	73-77
2.3.2 Endocrine circadian rhythms	77-80
2.3.3 RNA analysis	80-82
2.3.4 Normalisation of clock gene expression	83-92
2.3.5 Correlations of the behavioural data with the endocrine and molecular measures	93-94
2.4 Discussion	95-100
2.4.1 Actigraphy and chronotype	95-96
2.4.2 Endocrine circadian rhythms	96
2.4.3 RNA analysis	96-97
2.4.4 Normalisation of clock gene expression	97-98

2.4.5 Correlations of the behavioural data with the endocrine and molecular measures	98-99
2.4.6 Conclusions	99-100
Chapter 3: Circadian rhythms in adult Attention deficit-/hyperactivity disorder	101-145
3.1 Introduction	102-104
3.2 Methods	105-111
3.3 Results	112-135
3.3.1 Actigraphy and Diurnal Preference	112-120
3.3.2 Clock gene and hormone rhythms	120-135
3.3.3 rs1801260 polymorphism in <i>CLOCK</i>	135
3.4 Discussion	136-145
3.4.1 Actigraphy & diurnal preference	136-137
3.4.2 Clock gene rhythms	138
3.4.3 Melatonin	138-139
3.4.4 Cortisol	139-141
3.4.5 Relationship between the behavioural and molecular rhythms	141-142
3.4.6 Relationship between the behavioural and endocrine rhythms	142-144
3.4.7 rs1801260 polymorphism in <i>CLOCK</i>	144
3.4.8 Conclusions	144-145
Chapter 4: The effects of ADHD medication upon circadian clock protein expression in the rodent brain	146-209
4.1 Introduction	147-150
4.2 Methods	151-155
4.3 Results	156-196
4.3.1 Circadian clock protein expression in the hypothalamus	156-164
4.3.2 Circadian clock protein expression in the limbic forebrain	165-175
4.3.3 Circadian clock protein expression in the cerebral cortex	176-182
4.3.4 Circadian clock protein expression in the striatum	183-191

4.3.5 Circadian clock protein expression in the ventral tegmental area	192-196
4.4 Discussion	197-209
4.4.1 Circadian clock protein expression in the hypothalamus	197-201
4.4.2 Circadian clock protein expression in the limbic forebrain	201-203
4.4.3 Circadian clock protein expression in the cerebral cortex	203-204
4.4.4 Circadian clock protein expression in the striatum	204-207
4.4.5 Circadian clock protein expression in the ventral tegmental area	207-208
4.4.6 Mechanisms by which the ADHD medications interact with the circadian system	208-209
4.4.7 Conclusions	209
Chapter 5: Conclusions	210-214
5.1 Overall discussion	211-213
5.1.1 Conclusions	213-214
Appendix 1	215-217
Bibliography	218-293

Acknowledgements

Firstly I would like to thank my supervisors Professor Johannes Thome and Dr Andrew Coogan for their encouragement, guidance and support throughout the course of my PhD. I would also like to thank Dr Michel Barrot for kindly providing me with the excellent opportunity to carry out the animal work examining the effects of ADHD medications upon the rodent circadian system, at his laboratory at the Institute of Cellular and Integrative Neurosciences, Strasbourg University. Further thanks must go to Amy Beynon for her help with the immunohistochemistry techniques. Lastly I would like to thank family and friends for their patience and support over the last few months.

Figure and table legends

Page

Chapter 1: Introduction

Figure 1.1 Saggital view of the anatomical position of the suprachiasmatic nucleus of the hypothalamus (SCN) within the rat brain. 17

Figure 1.2 Illustration of the molecular mechanism of the circadian clock (Zanquetta et al., 2010). 20

Figure 1.3. The light input pathway to the SCN clockwork. (Reppert and Weaver, 2001). 29

Chapter 2: The development of a non-invasive technique for the assaying of human circadian clock function

Table 2.1. Chronometrics of the actigraphic circadian rhythm and the Horne-Ostberg morningness/eveningness (HO MEQ) score 74

Table 2.2. Summary of the actigraphically assessed sleep parameters 76

Table 2.3. Light exposure (lux) measured by the actiwatches worn by study participants. 77

Table 2.4. Chronometrics of the average 24-hour profiles of cortisol, melatonin, *GAPDH*, *BMAL1*, *PER2*, *PER1* and total mRNA concentration, assessed by co-sinor analysis. 78

Table 2.5. Co-sinor analysis of *PER1* expression to *GAPDH* expression. 91

Figure 2.1. Example actograms of the daily activity levels measured by the actiwatch. 75

Figure 2.2. Example of the average daily activity profiles measured by the actiwatch. 75

Figure 2.3. Example periodograms of the average period length of the activity rhythm, measured by the actiwatch. 75

Figure 2.4. Co-sinor analysis of salivary cortisol	79
Figure 2.5. Co-sinor analysis of salivary melatonin.	80
Figure 2.6. Co-sinor analysis of total mRNA concentration.	81
Figure 2.7. Example chromatograms obtained from the Experion electrophoresis analysis of the RNA samples.	82
Figure 2.8. Co-sinor analysis of non-normalised raw <i>GAPDH</i> expression levels	83-84
Figure 2.9. Co-sinor analysis of non-normalised raw <i>BMAL1</i> expression levels	84
Figure 2.10. Co-sinor analysis of non-normalised raw <i>PER2</i> expression levels.	85
Figure 2.11. Co-sinor analysis of non-normalised raw <i>PER1</i> expression levels	86
Figure 2.12. Co-sinor analysis of <i>BMAL1</i> expression normalised to <i>GAPDH</i> expression.	88
Figure 2.13. Co-sinor analysis of <i>BMAL1</i> expression normalised to total mRNA concentration.	89
Figure 2.14. Co-sinor analysis of <i>PER2</i> expression normalised to <i>GAPDH</i> expression.	90
Figure 2.15. Co-sinor analysis of <i>PER2</i> expression to total mRNA concentration.	91
Figure 2.16. Co-sinor analysis of <i>PER1</i> expression to total mRNA concentration	92
Figure 2.17. Significant correlations between the chronometrics of the actigraphic circadian rhythm and the chronometrics of the <i>BMAL1</i> , <i>PER2</i> and cortisol.	94

Chapter 3: Circadian rhythms in adult Attention deficit-/hyperactivity disorder

Table 3.1 Demographic and clinical data	104
Table 3.2. Chronometrics of the actigraphic circadian rhythm, and the Horne-Ostberg morningness/eveningness (HO MEQ) score.	113
Table 3.3. Summary of the actigraphically assessed sleep parameters.	116

Table 3.4. Light exposure (lux) as measured by the actiwatches worn by study participants.	117
Table 3.5. Chronotype assigned according to the Horne-Ostberg morningness/eveningness questionnaire.	118
Table 3.6. Chronometrics of the <i>BMAL1</i> , <i>PER2</i> , melatonin and cortisol rhythms, as assessed by co-sinor analysis.	120
Table 3.7. Genotype and allele frequencies (%) of the CLOCK rs1801260 polymorphism of the adult ADHD patient and control groups.	135
Figure 3.1. Example actograms of the daily activity levels measured by the actiwatch.	114
Figure 3.2. Example of average daily activity profiles as measured by the actiwatch.	114
Figure 3.3. Example periodograms of the average period length of the activity rhythm as measured by the actiwatch.	115
Figure 3.4. Significant correlations between the DSM index ADHD score and activity and sleep parameters.	119
Figure 3.5. Analysis of the rhythmic expression of <i>BMAL1</i> .	121
Figure 3.6. Analysis of the rhythmic expression of <i>PER2</i> .	122-123
Figure 3.7. Analysis of the rhythmic salivary melatonin profile.	123-124
Figure 3.8. Analysis of the rhythmic salivary cortisol profile.	125
Figure 3.9. Significant correlations between the DSM index ADHD score and the chronometrics of the <i>BMAL1</i> , <i>PER2</i> and cortisol profiles.	126
Figure 3.10. Significant correlations between the parameters of the behavioural and the molecular rhythms.	128
Figure 3.11. Significant correlations between the actigraphic circadian rhythm measures and the chronometrics of the salivary cortisol rhythm.	130
Figure 3.12. Significant correlations between the actigraphically assessed sleep parameters and the chronometrics of circadian clock gene expression.	131
Figure 3.13. Significant correlations between sleep parameters and chronometrics of the salivary melatonin rhythm.	132
Figure 3.14. Significant correlations between the actigraphically	134-135

assessed sleep parameters and the chronometrics of the salivary cortisol rhythm.

Chapter 4: The effects of ADHD medication upon circadian clock protein expression in the rodent brain

Table 4.1. Acrophases of rhythmic immunoreactivity of CLOCK, PER1, PER2 and c-Fos in the hypothalamus of each treatment group. 157

Table 4.2. Acrophases of rhythmic immunoreactivity of CLOCK, PER1, PER2 and c-Fos in the limbic forebrain of each treatment group. 165

Table 4.3. Acrophases of rhythmic immunoreactivity of CLOCK, PER1, PER2 and c-Fos in the cerebral cortex of each treatment group; saline (SAL), methylphenidate (MPD) and atomoxetine (ATO). 176

Table 4.4. Acrophases of rhythmic immunoreactivity of CLOCK, PER1, PER2 and c-Fos in the striatum of each treatment group; saline (SAL), methylphenidate (MPD) and atomoxetine (ATO). 184

Table 4.5. Acrophases of rhythmic immunoreactivity of CLOCK, PER1, PER2 and c-Fos in the VTA of each treatment group; saline (SAL), methylphenidate (MPD) and atomoxetine (ATO). 192

Figure 4.1 Photomicrographs of immunostaining in the SCN of saline control mice, using primary antibodies that have been blocked with the corresponding immunizing peptide. 154

Figure 4.2. CLOCK immunoreactivity measured as immunoreactive cell counts in the SCN, DMH and PVN of mice chronically treated with either saline control, MPD or ATO. 158

Figure 4.3. Photomicrographs of CLOCK immunostaining in the SCN and DMH during the mid subjective day (ZT8) and mid subjective night (ZT20) and in the PVN during the early subjective day (ZT2) and early subjective night (ZT14) of mice that underwent chronic treatment of MPD, ATO or a saline control. 158

Figure 4.4. PER1 immunoreactivity measured as immunoreactive cell counts in the SCN, DMH and PVN of mice chronically treated 160

with saline control (SAL), MPD or ATO.

Figure 4.5. Photomicrographs of PER1 immunostaining in the SCN and PVN (early subjective day (ZT2) and early subjective night (ZT14) and in the DMH (mid subjective day (ZT8) and mid subjective night (ZT20), of mice chronically treated with MPD, ATO or saline control. 160

Figure 4.6. PER2 immunoreactivity measured as immunoreactive cell counts in the SCN, DMH and PVN of mice chronically treated with either saline control, MPD or ATO. 162

Figure 4.7. Photomicrographs of PER2 immunostaining in the SCN and PVN (early subjective day (ZT2) and early subjective night (ZT14) and in the DMH (mid subjective day (ZT8) and mid subjective night (ZT20) of mice chronically treated with either MPD, ATO or saline control (SAL) 162

Figure 4.8. c-Fos immunoreactivity measured as immunoreactive cell counts in the SCN, DMH and PVN of mice chronically treated with saline control (SAL), MPD or ATO. 164

Figure 4.9. Photomicrographs of c-Fos immunostaining in the SCN and PVN during the mid subjective day (ZT8) and mid subjective night (ZT20) and in the DMH during the early subjective day (ZT2) and the early subjective night (ZT14), of mice that underwent chronic treatment of MPD, ATO or saline control (SAL). 164

Figure 4.10. CLOCK immunoreactivity measured by immunoreactive cell counts in the CA1, CA3, DG, BLA and CEA of mice that underwent chronic treatment of either a saline control (SAL), methylphenidate (MPD) or atomoxetine (ATO). 166-167

Figure 4.11. Photomicrographs of CLOCK immunostaining in the hippocampus and in the CEA during the mid subjective day (ZT8) and mid subjective night (ZT20) and in the BLA during the early subjective day (ZT2) and early subjective night (ZT14) of mice that underwent chronic treatment of either methylphenidate (MPD), atomoxetine (ATO) or a saline control (SAL). 167

Figure 4.12. PER1 immunoreactivity measured by immunoreactive cell counts in the CA1, CA3, DG, BLA and CEA of mice that underwent chronic treatment of either a saline control (SAL), 169-170

methylphenidate (MPD) or atomoxetine (ATO).	
Figure 4.13. Photomicrographs of PER1 immunostaining in the hippocampus and in the BLA and CEA during the early subjective day (ZT2) and early subjective night (ZT14) of mice that underwent chronic treatment of either methylphenidate (MPD), atomoxetine (ATO) or a saline control (SAL).	170
Figure 4.14. PER2 immunoreactivity measured by immunoreactive cell counts in the CA1, CA3, DG, BLA and CEA of mice that underwent chronic treatment of either a saline control (SAL), methylphenidate (MPD) or atomoxetine (ATO).	171-172
Figure 4.15. Photomicrographs of PER2 immunostaining in the hippocampus and in the BLA during the early subjective day (ZT2) and early subjective night (ZT14) and in the CEA during the mid subjective day (ZT8) and mid subjective night (ZT20) of mice that underwent chronic treatment of methylphenidate (MPD), atomoxetine (ATO) or a saline control (SAL).	172
Figure 4.16. c-Fos immunoreactivity measured by immunoreactive cell counts in the CA1, CA3, DG, BLA and CEA of mice that underwent chronic treatment of either a saline control (SAL), methylphenidate (MPD) or atomoxetine (ATO).	174-175
Figure 4.17. Photomicrographs of c-Fos immunostaining in the hippocampus and in the BLA and CEA during the early subjective day (ZT2) and early subjective night (ZT14) of mice that underwent chronic treatment of either methylphenidate (MPD), atomoxetine (ATO) or a saline control (SAL).	175
Figure 4.18. CLOCK immunoreactivity measured by immunoreactive cell counts in the CC, PLC and ILC of mice chronically treated with saline control (SAL), methylphenidate (MPD) or atomoxetine (ATO).	177
Figure 4.19. Photomicrographs of CLOCK immunostaining in the CC, PLC and ILC of mice that underwent chronic treatment of either methylphenidate (MPD), atomoxetine (ATO) or a saline control (SAL) during the early subjective day (ZT2) and early subjective night (ZT14).	177
Figure 4.20. PER1 immunoreactivity measured by immunoreactive	178

cell counts in the CC, PLC and ILC of mice chronically treated with either saline control (SAL), methylphenidate (MPD) or atomoxetine (ATO).

Figure 4.21. Photomicrographs of PER1 immunostaining in the CC during the mid subjective day (ZT8) and mid subjective night (ZT20) and in the PLC and ILC during the early subjective day (ZT2) and early subjective night (ZT14), of mice that underwent chronic treatment of either methylphenidate (MPD), atomoxetine (ATO) or a saline control (SAL). 179

Figure 4.22. PER2 immunoreactivity measured by immunoreactive cell counts in the CC, PLC and ILC of mice chronically treated with saline control (SAL), methylphenidate (MPD) or atomoxetine (ATO). 180

Figure 4.23. Photomicrographs of PER2 immunostaining in the CC, PLC and ILC of mice that underwent chronic treatment of either methylphenidate (MPD), atomoxetine (ATO) or a saline control (SAL) during the early subjective day (ZT2) and early subjective night (ZT14). 180

Figure 4.24. c-Fos immunoreactivity measured by immunoreactive cell counts in the CC, PLC and ILC of mice chronically treated with saline control (SAL), methylphenidate (MPD) or atomoxetine (ATO). 182

Figure 4.25. Photomicrographs of c-Fos immunostaining in the CC and PLC (early subjective day (ZT2) and early subjective night (ZT14) and in the ILC (mid subjective day (ZT8) and mid subjective night (ZT20) of mice chronically treated with either methylphenidate (MPD), atomoxetine (ATO) or a saline control (SAL). 182

Figure 4.26. CLOCK immunoreactivity measured by immunoreactive cell counts in the CPu, AcbC and AcbSh of mice chronically treated with saline control (SAL), MPD or ATO. 185

Figure 4.27. Photomicrographs of CLOCK immunostaining measured by immunoreactive cell counts in the CPu (mid subjective day (ZT8) and mid subjective night (ZT20) and in the AcbC and AcbSh (early subjective day (ZT2) and early subjective night (ZT14) of mice that underwent chronic treatment of either methylphenidate (MPD), atomoxetine (ATO) or a saline control (SAL). 185

Figure 4.28. PER1 immunoreactivity measured by immunoreactive 187

cell counts in the CPu, AcbC and AcbSh of mice chronically treated with either saline control (SAL), methylphenidate (MPD) or atomoxetine (ATO).

Figure 4.29. Photomicrographs of PER1 immunostaining measured by immunoreactive cell counts in the CPu, AcbC and AcbSh of mice that underwent chronic treatment of either methylphenidate (MPD), atomoxetine (ATO) or a saline control (SAL) during the early subjective day (ZT2) and early subjective night (ZT14). 187

Figure 4.30. PER2 immunoreactivity measured by immunoreactive cell counts in the CPu, AcbC & AcbSh of mice chronically treated with saline control (SAL), MPD or ATO. 189

Figure 4.31. Photomicrographs of PER2 immunostaining in the CPu and AcbC during the early subjective day (ZT2) and early subjective night (ZT14) and in the AcbSh during the mid subjective day (ZT8) and mid subjective night (ZT20) of mice that underwent chronic treatment of MPD, ATO or a saline control (SAL). 189

Figure 4.32. c-Fos immunoreactivity measured by immunoreactive cell counts in the CPu, AcbC and AcbSh of mice chronically treated with saline control (SAL), MPD or ATO. 191

Figure 4.33. Photomicrographs of c-Fos immunostaining in the CPu, AcbC and AcbSh of mice that underwent chronic treatment of either methylphenidate (MPD), atomoxetine (ATO) or a saline control (SAL) during the early subjective day (ZT2) and early subjective night (ZT14). 191

Figure 4.34. CLOCK immunoreactivity measured by immunoreactive cell counts in the VTA of mice that underwent chronic treatment of saline control (SAL), MPD or ATO. 193

Figure 4.35. Photomicrographs of CLOCK immunostaining in the VTA of mice that underwent chronic treatment of either methylphenidate (MPD), atomoxetine (ATO) or a saline control (SAL) during the early subjective day (ZT2) and early subjective night (ZT14). 193

Figure 4.36. PER1 immunoreactivity measured by immunoreactive cell counts in the VTA of mice that underwent chronic treatment of 194

a saline control (SAL), methylphenidate (MPD) or atomoxetine (ATO).	
Figure 4.37. Photomicrographs of PER1 immunostaining in the VTA of mice that underwent chronic treatment of either methylphenidate (MPD), atomoxetine (ATO) or a saline control (SAL) during the early subjective day (ZT2) and early subjective night (ZT14).	194
Figure 4.38. PER2 immunoreactivity measured by immunoreactive cell counts in the VTA of mice that underwent chronic treatment of a saline control (SAL), methylphenidate (MPD) or atomoxetine (ATO).	195
Figure 4.39. Photomicrographs of PER2 immunostaining in the VTA of mice that underwent chronic treatment of either methylphenidate (MPD), atomoxetine (ATO) or a saline control (SAL) during the early subjective day (ZT2) and early subjective night (ZT14).	195
Figure 4.40. c-Fos immunoreactivity measured by immunoreactive cell counts in the VTA of mice that underwent chronic treatment of saline control (SAL), MPD or ATO.	196
Figure 4.41. Photomicrographs of c-Fos immunostaining in the VTA of mice that underwent chronic treatment of either methylphenidate (MPD), atomoxetine (ATO) or a saline control (SAL) during the mid subjective day (ZT8) and mid subjective night (ZT20).	196

Appendix 1: A comparison of the statistical analysis of the immunoreactivity data assessed by immunoreactive cell counts and optical density.

A1.1 Summary table comparing the co-sinor analysis of CLOCK, PER1, PER2 and c-Fos immunoreactivity assessed by measurement of immunoreactive cell counts and optical density.	215
A1.2 Summary table comparing the ANOVA statistics of the CLOCK, PER1, PER2 and c-Fos immunoreactivity data assessed by measurement of immunoreactive cell counts and optical density.	216-217

Abbreviations

°C	Degrees Celsius
18S	18S subunit of ribosomal RNA
28S	28S subunit of ribosomal RNA
5-HT	5-hydroxytryptamine / serotonin
AA-NAT	Arylalkylamine N-acetyltransferase
AcbC	Core region of the nucleus accumbens
AcbSh	Shell region of the nucleus accumbens
ADHD	Attention deficit-/hyperactivity disorder
ANOVA	Analysis of variance
ASRS	Adult ADHD self report scale
ATO	Atomoxetine
AUC_G	Area under the curve with respect to ground
AUC_I	Area under the curve with respect to increase
AVP	Arginine vasopressin
BLA	Basolateral amygdala
BMAL1	Aryl hydrocarbon receptor nuclear translocator-like protein 1
bp	Base pair
CAARS	Conner's adult ADHD rating scales
cAMP	Cyclic adenosine monophosphate
CC	Cingulate cortex
CCGs	Clock controlled genes
CeA	Central nucleus of the amygdala
c-Fos	Cellular FBJ osteosarcoma oncogene
CI AMP	95% confidence interval for estimation of the amplitude
CI Acro	95% confidence interval for estimation of the acrophase
CK1 ϵ	Casein kinase 1 ϵ
CK1 δ	Casein kinase 1 δ
CLOCK	Circadian locomoter output cycles protein kaput
CNS	Central nervous system
CPu	Caudate putamen
CRE	Cyclic AMP response elements
CREB	Cyclic AMP response element binding protein

CRY	Cryptochrome
DBP	Albumin D-element-binding-protein
DD	Constant darkness
DRD3	Dopamine D3 receptor gene
DRD4	Dopamine D4 receptor gene
DRD5	Dopamine D5 receptor gene
DSPS	Delayed sleep phase syndrome
<i>DEC2</i>	Differentiated embryonic chondrocyte gene 2
DLMO	Dim light melatonin onset
DSM	Diagnostic and Statistical Manual of Mental Disorders
DAT	Dopamine transporter
DMH	Dorsal medial nucleus of the hypothalamus
DG	Dendate gyrus of the hippocampus
DNA	Deoxyribonucleic acid
D1	Dopamine receptor 1
D2	Dopamine receptor 2
D3	Dopamine receptor 3
ELISA	Enzyme linked immunosorbent assay
ERK	Extracellular-signal-regulated kinase
FASPS	Familial advanced sleep phase syndrome
fMRI	Functional magnetic resonance imaging
FTA	Flinders Technical Associates
g	Acceleration due to gravity
GABA	γ -aminobutyric acid
GAPDH	Glyceraldehyde-3 phosphate dehydrogenase
GR	Glucocorticoid receptor
GSK3 β	Glycogen synthase kinase-3 beta
h	Hours
HPA axis	Hypothalamic-pituitary-adrenal axis
HO MEQ	Horne Ostberg morningness/eveningness questionnaire
ILC	Prefrontal infralimbic cortex
IS	Interdaily stability
IV	Intradaily variability
LD	12:12 hr light dark cycle

L5	Amount of activity in the 5 hours of least activity
L5o	Time of onset of L5
MAO	Monoamine oxidase
MAOA	Monoamine oxidase A
MAOB	Monoamine oxidase B
MAP	Methamphetamine
min	Minutes
MPD	Methylphenidate
MR	Mineralocorticoid receptors
mRNA	Messenger RNA
MT ₁	Subtype of G-protein coupled receptors
MT ₂	Subtype of G-protein coupled receptors
M10	Amount of activity in the 10 hours of most activity
M10o	Time of onset of M10
NET	Noradrenaline / norepinephrine transporter
NGS	Normal goat serum
nickel DAB	Nickel enhanced Diaminobenzidine
nm	Nanometers
NO	Nitric oxide
NPAS2	Neuronal PAS domain protein 2
PACAP	Pituitary adenylate cyclise-activating peptide
PAS domains	Period-Arnt-Single-minded domains
PBS	Phosphate buffered saline
PBX	Phosphate buffered saline with 0.03% Triton-X-100
PC	Personal computer
PCR	Polymerase chain reaction
PER	Period
PFA	Para-formaldehyde
pH	Potential of hydrogen
PLC	Prefrontal prelimbic cortex
PSA-NCAM	Polysialic acid neural cell adhesion molecule
PVN	Paraventricular nucleus of hypothalamus
RA	Relative amplitude
REM	Rapid eye movement

REV-ERB α	Reverse erythroblastosis virus α
REV-ERB β	Reverse erythroblastosis virus β
RFLP	Restriction fragment length polymorphism
RHT	Retinohypothalamic tract
RIN	RNA Integrity number
RNA	Ribonucleic acid
ROR α	Retinoic acid related orphan receptor alpha
RQI	RNA quality index
rRNA	Ribosomal RNA
RT-PCR	Real time polymerase chain reaction
s	Seconds
SAL	Saline
SCID-RV	Structured clinical interview for DSM-IV-TR–research version
SCN	Suprachiasmatic hypothalamic nucleus
SHR	Spontaneous hypertensive rat
SLC6A2	Noradrenaline transporter gene
SLC6A4	Serotonin transporter gene
SNAP25	Synaptosomal-associated protein of 25 kDa
SNP	Single nucleotide polymorphism
SOD	Superoxide dismutase
VIP	Vasoactive intestinal polypeptide
VNTR	Variable nucleotide length tandem repeat
VTA	Ventral tegmental area
WKY	Wistar-Kyoto rat
WURS	Wender-Utah rating scale for retrospective information on childhood ADHD
ZT	Zeitgeber
μ l	Microlitres
μ m	Micrometers

Chapter 1: Introduction

Chapter 1: Introduction

1.1 Introduction to the Circadian Clock

Circadian rhythms are recurring patterns in behaviour and physiology that repeat approximately every twenty-four hours (Hastings and Maywood, 2000, Reppert and Weaver, 2001). This time-keeping system enables an organism to predict cyclical changes in its environment and to synchronize and temporally coordinate numerous behavioural and physiological processes accordingly, thus enabling the organism to function in the most efficient manner in response to its environmental conditions (Hastings and Maywood, 2000, Guilding and Piggins, 2007, Emerson et al., 2008). Circadian rhythms are observed throughout biology, in as varied processes as sleeping, eating, mental alertness, seasonal migration and cell proliferation (Gillette and Sejnowski, 2005, Guilding and Piggins, 2007).

In mammals the master circadian pacemaker resides in the suprachiasmatic nuclei (SCN) of the anterior hypothalamus (Guilding and Piggins, 2007) and it is responsible for the generation of circadian rhythms. The SCN is entrained to the 24 hour day by receiving light pulses via a specialised neural tract, termed the retinohypothalamic tract (RHT) (Piggins and Loudon, 2005), although the presence of an extra SCN food entrainable oscillator has also been demonstrated (Herzog and Muglia, 2006). The role of the SCN as the master pacemaker is confirmed by evidence that SCN lesions abolish most physiological, endocrine and behavioural rhythms (Moore and Eichler, 1972, Stephan and Zucker, 1972, Guilding and Piggins, 2007), and SCN transplants can restore rhythmicity in previously arrhythmic, SCN-lesioned rodents (Ralph et al., 1990, King et al., 2003, Sujino et al., 2003, Guilding and Piggins, 2007). Furthermore, the tau mutant hamster, which possesses a gain-of-function mutation in the casein kinase 1 ϵ (CK1 ϵ) gene, the protein of which is key for post-translational modifications of the molecular circadian clock, exhibits a shortened, 20-h clock period (Ralph and Menaker, 1988, Reppert and Weaver, 2001, Meng et al., 2008). However, transplantation of the SCN of wild-type hamsters into the tau mutant hamster, has been shown to lengthen the circadian period, producing a free-running rhythm set by the transplanted SCN (Ralph et al., 1990). The SCN consists of two paired nuclei, each nucleus containing ~10000 neurons (Reppert and

Weaver, 2001, Guilding and Piggins, 2007), and it is situated bilateral to the third ventricle and immediately dorsal to the optic chiasm (Abrahamson and Moore, 2001, Guilding and Piggins, 2007). The positioning of the SCN is therefore optimal for receiving visual input for entrainment to the light-dark cycle (Reppert and Weaver, 2001).

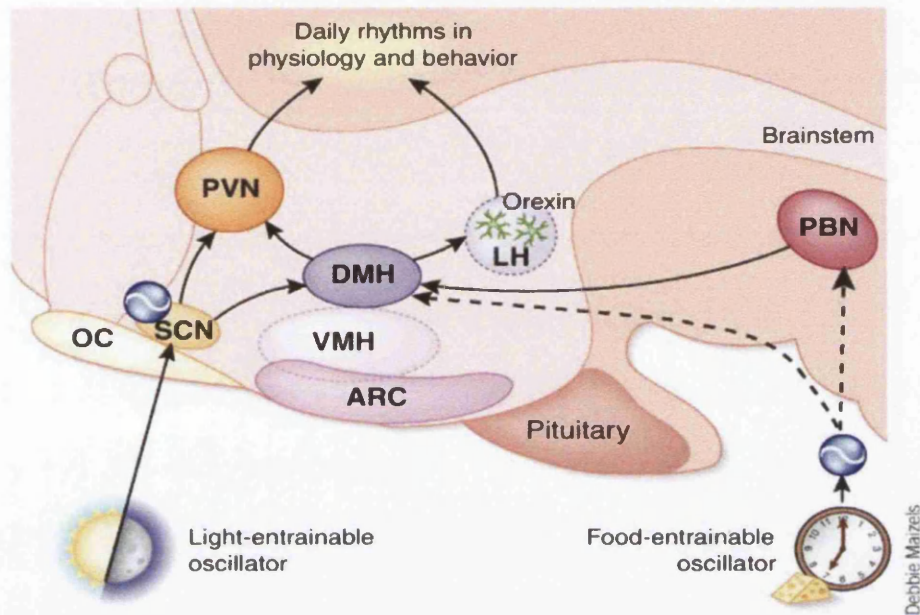

Figure 1.1 Sagittal view of the anatomical position of the suprachiasmatic nucleus of the hypothalamus (SCN) within the rat brain. The SCN is the site of the master pacemaker, for which the light-dark cycle is the predominant entrainment factor, and is located above the optic chiasm (OC). A food-entrainable oscillator also exists, although its brain site has not been confirmed. DMH = dorsomedial hypothalamic nucleus, PVN = paraventricular hypothalamic nucleus, VMH = ventromedial hypothalamic nucleus, ARH = arcuate nucleus, LH = lateral hypothalamus, PBN = parabrachial nucleus (Herzog and Muglia, 2006).

The SCN can be separated into a ventrolateral ‘core’ region and a dorsomedial ‘shell’ region (Guilding and Piggins, 2007), which are functionally distinct with the core region receiving direct retinal innervations from the RHT and hence providing a daily entrainment signal through the activation of core clock genes and intracellular signalling pathways, to synchronize the rhythmic output from the SCN shell (Guilding and Piggins, 2007). Furthermore the molecular clockwork of the two

regions differs as a greater number of cells exhibit rhythmic clock gene expression in the shell than the core SCN, the acrophase of expression occurs earlier in the day in the shell than the core (Hamada et al., 2001, Guilding and Piggins, 2007), whilst light induced phase shifts in clock gene expression are delayed in the shell region compared to the core SCN (Hamada et al., 2001, Guilding and Piggins, 2007). Moreover, the two regions can also be distinguished on their cell type, with arginine vasopressin (AVP) synthesizing neurons being characteristic of the shell region (Vandesande et al., 1975, van den Pol and Tsujimoto, 1985), whilst vasoactive intestinal polypeptide (VIP) and gastrin-releasing peptide expressing neurons are associated with the core region of the SCN (Card et al., 1981, Card and Moore, 1984, Card et al., 1988).

Electrical output of the SCN

Neuronal firing is a key output signal of the SCN (Hirota and Fukada, 2004), which has been demonstrated in rats, where when SCN neuronal firing is blocked, their behaviour becomes arrhythmic, and rhythmicity is only restored when SCN neuronal firing is restored (Schwartz et al., 1987, Schwartz, 1991). This demonstrates that not only is rhythmic electrical activity an output of the SCN rather than a critical component of the clock, but also that the clock continues to keep time when electrical output is silenced (Reppert and Weaver, 2001). Electrical firing rate exhibits a rhythm with a period of ~ 24 hours in the SCN, with a higher frequency during the day and lower frequency during the night (Inouye and Kawamura, 1979, Green and Gillette, 1982, Groos and Hendriks, 1982, Shibata et al., 1982, Meijer et al., 1998, Guilding and Piggins, 2007).

There are core and shell differences in electrical activity however, with generally a greater number of cells possessing circadian rhythmicity in electrical activity in the shell than in the core, and peak firing rate occurs earlier in the day in the SCN shell than the core (Hamada et al., 2001, Schaap et al., 2003, Yamaguchi et al., 2003 Hamada et al., 2004, Maywood et al., 2006). The synchronization of electrical activity of the individual neurons to a single period in the SCN is thought to be due to sodium-dependant action potentials (Yamaguchi et al., 2003), with rhythmic alterations in membrane potential and/or channel activity being thought to be

responsible for the rhythmic electrical activity of SCN neurons (de Jeu et al., 1998, Schaap et al., 1999, Reppert and Weaver, 2001). Additionally, the neuropeptide VIP has been implicated in the maintenance and synchronisation of the molecular clockwork and electrical firing of SCN neurons (Cutler et al., 2003, Aton et al., 2005, Brown et al., 2005, Maywood et al., 2006, Brown et al., 2007, Guilding and Piggins, 2007).

Efficient coupling of the SCN is essential for entrainment of the circadian clock, since this will enable the whole network to resynchronize when a subset of cells receive phase shifting stimuli (Reppert and Weaver, 2001). Gap junctions have been proposed to contribute to the synchronisation of subsets of SCN neurons and the amplification of their collective output (Reppert and Weaver, 2001), and the neurotransmitter GABA. Nearly all the neurons of the SCN express the neurotransmitter GABA (Moore and Speh, 1993, Reppert and Weaver, 2001, Guilding and Piggins, 2007), which is responsible for exciting SCN neurons in the daytime and inhibiting electrical activity during the night (Wagner et al., 1997), and has been implicated in the synchronizing of SCN neurons in vitro (Liu and Reppert, 2000). The neuronal cell adhesion molecule PSA-NCAM has also been proposed as a possible synchronizing factor of the SCN (Reppert and Weaver, 2001), since it is known to play a role in the regulation of neuronal plasticity in other systems (Theodosis et al., 1999). Furthermore, PSA-NCAM deficient mice exhibit shortened circadian periods of behaviour eventually becoming arrhythmic in constant conditions, thus suggesting that PSA-NCAM could be involved in SCN coupling (Shen et al., 1997, Reppert and Weaver, 2001).

The molecular basis of the circadian clock

The molecular basis of circadian rhythm generation consists of both positive and negative transcriptional/translational feed forward and feedback loops of clock genes and their protein products (figure 1.2). The positive loop consists of the basic helix-loop-helix transcription factors BMAL1 and CLOCK, which form a heterodimer in the cytoplasm via PAS (Period-Arnt-Single-minded) domains (Guilding and Piggins, 2007), the BMAL1-CLOCK complex then translocates to the nucleus where it activates the transcription of *PER*, *CRY*, *REV-ERB α* , *ROR α* and various clock

controlled genes by binding to E-box enhancer sequences (Gekakis et al., 1998, van der Horst et al., 1999, Guilding and Piggins, 2007, Zanquetta et al., 2010). Accumulation of the PER and CRY proteins then occurs in the cytoplasm, where the proteins dimerize and are translocated to the nucleus, thus inhibiting CLOCK-BMAL1-dependent transcriptional activation, which in turn inhibits their own transcription (Reppert and Weaver, 2002, Hastings and Herzog, 2004, Hirota and Fukada, 2004, Guilding and Piggins, 2007, Zanquetta et al., 2010) The PER2 and ROR α proteins also support the rhythmic transcription of *BMAL1*, thus forming a positive feedback loop (Reppert and Weaver, 2001, Zanquetta et al., 2010). *REV-ERB α* has an inhibitory effect upon the transcription of *BMAL1*, whereas PER-CRY inhibits *REV-ERB α* transcription, therefore forming a positive loop, that prohibits *REV-ERB α* inhibition of *BMAL1* transcription, and so activates the system (Preitner et al., 2002, Guilding and Piggins, 2007). Since presumably the *BMAL1* rhythm drives the BMAL1 protein rhythm with a 4-6hr delay, the renewal of BMAL1 protein levels at the appropriate circadian time will result in a restart of the cycle and it would therefore seem that BMAL1 protein levels are a rate-limiting factor for heterodimer formation (Reppert and Weaver, 2001).

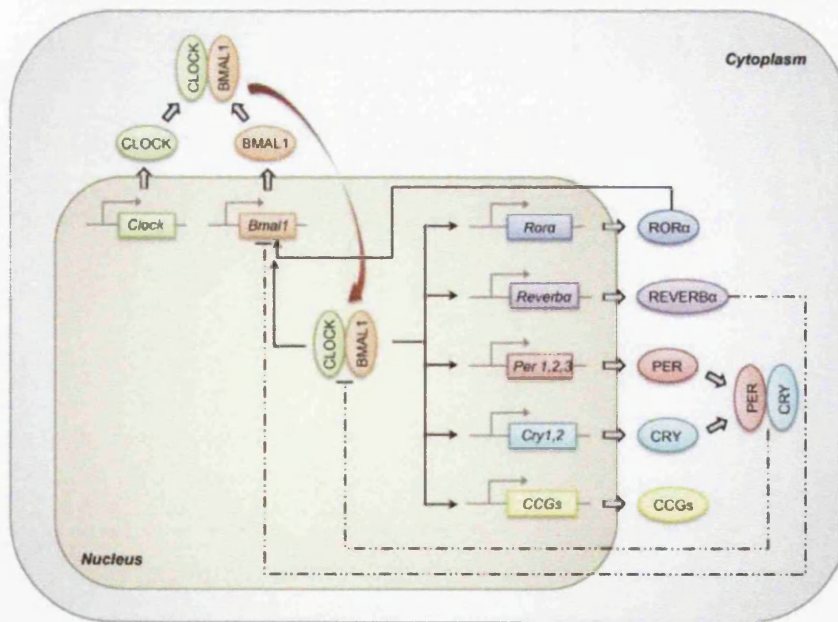

Figure 1.2. Illustration of the molecular mechanism of the circadian clock. CCGs = clock controlled genes. Solid line = positive feedback, dashed line = negative feedback. (Zanquetta et al., 2010).

The majority of the core molecular clockwork components of the SCN exhibit a circadian rhythm in their expression under both a light-dark (LD) cycle and constant conditions, including *PER1*, *PER2*, *CRY1*, *REV-ERB α* and *BMAL1* (Guilding and Piggins, 2007). *CRY2* is expressed in the SCN, but without a clearly defined rhythm, and *CLOCK* is constitutively expressed across the circadian cycle (Gekakis et al., 1998, Oster et al., 2003, Guilding and Piggins, 2007). In addition to the core clock genes, there are also a number of clock controlled genes that are rhythmically expressed in the SCN, including arginine vasopressin (AVP) and albumin D-element-binding-protein (DBP) (Reppert and Weaver, 2001). AVP is thought to play a role in augmenting SCN excitability (Mihai et al., 1994, Ingram et al., 1996) via both autocrine and paracrine mechanisms (Reppert and Weaver, 2001), whereas DBP acts as a transcription factor that may regulate the availability of a channel involved in the regulation of membrane potential (Reppert and Weaver, 2001), although, it has been speculated that DBP may actually play a role in the circadian clock, since DBP-deficient mice exhibit shortened circadian periods of locomotor activity (Lopez-Molina et al., 1997, Reppert and Weaver, 2001).

Analysis of rodent models that are deficient in various core clock components provides further information on their roles in the molecular circadian clock as well as possible non-clock functions. Some of the core clock components of the circadian system appear to be functionally redundant in the SCN (Lakin-Thomas, 2006), as demonstrated by the maintenance of circadian rhythms of locomotor activity and clock gene expression in the SCN in *CLOCK* knockout mice (Debruyne et al., 2006, Guilding and Piggins, 2007). In this situation it has been proposed that Neuronal PAS domain protein 2 (NPAS2), a functional analogue of *CLOCK* (Reick et al., 2001) may be able to function in the place of *CLOCK* under these conditions in the mouse SCN (Asher and Schibler, 2006). However, although NPAS2 is thought to be a functional analogue of *CLOCK*, it does not function as efficiently as its counterpart. This is demonstrated by the shortened circadian periods in constant darkness of mice that are deficient in *CLOCK* but possess one functional NPAS2 allele, in comparison to NPAS2 deficient mice that possess one functional *CLOCK* allele and display behavioural rhythmicity in constant darkness that is similar to the wild-type control (DeBruyne et al., 2007a). However, it is not yet clear whether NPAS2 only plays a functionally relevant role in the absence of *CLOCK* or whether

both proteins actually function co-ordinately within the SCN (DeBruyne et al., 2007a). However a number of alterations in the dopaminergic reward system of CLOCK mutant mice suggest that this protein may also have a non-clock function in the system. These alterations include elevated locomotion levels and increased sensitivity to cocaine reward, increased expression of tyrosine hydroxylase mRNA and protein, (the rate limiting enzyme for dopamine biosynthesis), increased levels of the phosphorylated form of the protein in the ventral tegmental area (VTA) and elevated impulse activity of the VTA dopaminergic neurons (McClung et al., 2005). Furthermore, CLOCK mutant mice have been shown to exhibit an increase in exploratory activity in novel environments (Easton et al., 2003, McClung et al., 2005, Roybal et al., 2007, Rosenwasser, 2010) and decreased depression and anxiety-like behaviours (Roybal et al., 2007, Rosenwasser, 2010), and therefore CLOCK mutant mice have been proposed as a rodent model for mania (Roybal et al., 2007, Lamont et al., 2010). NPAS2 has been shown to be implicated in the regulation of behaviour, as demonstrated by an association of a mutation in *NPAS2* with increased spontaneous wheel running behaviour (Dudley et al., 2003, Rosenwasser, 2010). It has been postulated that one mechanism by which clock genes could interact with the dopaminergic system is via E-box element sequences found on the tyrosine hydroxylase gene (Yoon and Chikaraishi, 1994, McClung et al., 2005).

A recent study has suggested that *BMAL1* may not be essential for circadian clock functioning, since *BMAL1* knockout mice exhibit circadian rhythmicity in numerous physiological activities including metabolism and locomotor activity, when *BMAL2* is expressed from a constitutively expressed promoter (Shi et al., 2010) It is therefore thought that *BMAL1* and *BMAL2* form a functionally redundant paralogue pair (Shi et al., 2010). Furthermore, in *BMAL1* knockout mice *BMAL2* expression is downregulated, and therefore it would seem that the *BMAL2* promoter may be under a form of regulation by BMAL1/CLOCK and BMAL1/NPAS2 transactivation in the mouse (Shi et al., 2010). However, *BMAL1* does appear to be important in sleep regulation as homozygous *BMAL1* knockout mice exhibit dampened sleep/wake rhythms and sleep abnormalities such as increased sleep duration and fragmentation, and insufficiencies in the response to sleep deprivation (Laposky et al., 2005).

In mice deletion of *CRY2* lengthens the circadian period, whereas *CRY1* deletion shortens the circadian period: it has been postulated that this difference may arise from differing affinities of the proteins for other clock components, or differing expression levels of the proteins, which may affect the kinetics of the molecular feedback loops (Reppert and Weaver, 2001). However when both genes are deleted there is a complete loss of circadian rhythmicity in locomotor activity immediately upon placement in constant darkness (DD), thus indicating that the proteins are mutually redundant (van der Horst et al., 1999, Vitaterna et al., 1999, Reppert and Weaver, 2001). Additionally, when both *CRY2* and *CRY1* are deleted there is a loss of circadian rhythmicity and maintenance of expression at mid-high levels across the circadian cycle of *PER1* and *PER2* in the SCN (Vitaterna et al., 1999, Reppert and Weaver, 2001).

Homozygous *mPER2^{Brdml}* mutant mice, have a deletion that encodes an 87 residue carboxyl section of the PAS dimerization domain (Zheng et al., 1999, Reppert and Weaver, 2001), and exhibit shorter circadian periods followed by a loss of circadian rhythmicity in DD (Reppert and Weaver, 2001). The RNA levels of *PER1*, *PER2* and *CRY1* are still rhythmic in the SCN of these mice, however they are reduced in amplitude (Zheng et al., 1999, Shearman et al., 2000b, Reppert and Weaver, 2001). Furthermore, homozygous *mPER2^{Brdml}* mutant mice exhibit blunted *BMAL1* rhythms, thus supporting the role of *PER2* in the positive regulation of *BMAL1* transcription (Zheng et al., 1999, Reppert and Weaver, 2001). Moreover, the altered response to drugs of abuse and the dampened expression of monoamine oxidase a (*MAOA*) and monoamine oxidase b (*MAOB*) in these animals implicates *PER2* in the mesolimbic dopaminergic system (Abarca et al., 2002, Spanagel et al., 2005, Hampp et al., 2008). The rhythmic expression of *mMAOA* is dampened in the VTA and expression of both *mMAOA* and *mMAOB* is dampened in the ventral striatum (nucleus accumbens) of *mPER2^{Brdml}* mutant mice, thus lowering the activity of MAO and causing an elevation of dopamine levels in the striatum (Hampp et al., 2008).

In *PER1* deficient mice *PER2* rhythms are unaltered and circadian rhythms in behaviour are maintained, hence it is thought that *PER1* is not as essential to core molecular clockwork as *PER2* (Zheng et al., 1999, Reppert and Weaver, 2001). *PER1* is thought to instead have influences at a post-transcriptional level by

regulating the stability of other circadian regulatory proteins (Bae et al., 2001). *PER3* is also not thought to be involved in the core circadian clockwork, since *PER3* mutant mice display a shortened circadian period, but maintain rhythmicity in DD (Shearman et al., 2000a, Reppert and Weaver, 2001), and although expression of mutant *PER3* transcripts is reduced in the SCN, its disruption does not have any considerable effect upon expression of other core clock components (Reppert and Weaver, 2001). It is however postulated that *PER3* may play a role in clock output (Reppert and Weaver, 2001), and in the human system *PER3* has been implicated in various aspects of sleep homeostasis and circadian timing. This is demonstrated by a variable-number (4 or 5) tandem-repeat polymorphism in the coding region of the clock gene *PER3*, which has been implicated in sleep homeostasis (Viola et al., 2007) and in executive performance under conditions of increasing sleep pressure due to sleep deprivation (Groeger et al., 2008, Vandewalle et al., 2009). This polymorphism has also been implicated in circadian timing, with an association of the 5-repeat polymorphism with morning preference and the 4-repeat polymorphism with evening preference (Dijk and Archer, 2010). Two single nucleotide polymorphisms (SNPs) within a polymorphic cluster of the gene have also been associated with delayed sleep phase syndrome (DSPS) (Archer et al., 2010).

The clock proteins are subject to post-translational modifications, thereby contributing to their stability and function and this process is thought to contribute to the imposing of a 24-hour time constant to the circadian clockwork (Reppert and Weaver, 2001), with in particular, the phosphorylation of *PER2* being shown to be significantly involved in setting the period of the clock (Wilkins et al., 2007). Phosphorylation of these proteins regulates the formation of protein complexes, their nuclear entry and their degradation via ubiquitination pathways (Meng et al., 2008). This post-translational modification is mainly carried out by two core clock components casein kinase 1 ϵ (CK1 ϵ) and casein kinase 1 δ (CK1 δ), which are highly homologous (Reppert and Weaver, 2001, Guilding and Piggins, 2007). As previously described the *tau* mutation is a gain-of-function mutation in the CK1 ϵ gene, resulting in a shortened circadian period by ~ 4 hours in comparison to the wild type animals (Ralph and Menaker, 1988, Reppert and Weaver, 2001, Meng et al., 2008). The mutation causes a substitution of a cysteine for a conserved arginine at residue 178, and functional analyses reveal that the mutant enzyme has reduced maximal velocity

and reduced autophosphorylation, therefore resulting in an enzyme with increased affinity to bind to PER1 and PER2, but decreased ability to phosphorylate them (Reppert and Weaver, 2001, Wilkins et al., 2007). In this situation binding of the mutant enzyme to PER, prevents PER from being able to bind to a functional enzyme (Reppert and Weaver, 2001). This is likely to impact upon PER by increasing its degradation, altering its stability and accelerating its turnover (Meng et al., 2008). Furthermore, in humans, a mutation in *PER2* at the site of phosphorylation (Ser 659) by CK1 ϵ is associated with a type of familial advanced sleep phase syndrome (FASPS) (Toh et al., 2001). The mutation causes hypophosphorylation, resulting in a phase advance, which is typically associated with a shorter free running period (Toh et al., 2001, Wilkins et al., 2007). Alterations in CK1 δ have also been associated with a form of familial advanced sleep phase syndrome (FASPS) (Xu et al., 2005, Wilkins et al., 2007). As previously mentioned, transplantation of the SCN of a wild-type hamster into the tau mutant hamster lengthens the circadian period, hence suggesting that the SCN is the site of the mutant CKI ϵ /tau gene that is responsible for the tau phenotype (Ralph et al., 1990). Furthermore, transfer of the wild-type CKI ϵ gene via electroporation into the SCN of tau mutant hamsters has been shown to lengthen the circadian period by up to 42 minutes (Wang et al., 2007). Although a lengthening of the circadian period was observed, the shortening by 4 hours observed in tau mutants was not restored, and this was thought to be due to the maintenance of the other casein kinases still present, which would compete with the transplanted CKI ϵ protein (Ishida et al., 2001, Wang et al., 2007).

The functional hierarchy of the circadian clock

The circadian system can be explained as a hierarchy, consisting of a master circadian pacemaker, and peripheral clocks, which are either semi-autonomous oscillators or slave oscillators (Guilding and Piggins, 2007) and which oscillate via a similar molecular mechanism to the master pacemaker (Balsalobre, 2002). A master circadian pacemaker can be defined as an oscillator that exhibits an endogenous, self-sustaining, approximate 24-hr rhythm that persists in isolation from all other tissues and external time-keeping cues, that maintains its period of free-running rhythms regardless of physiological temperature, that has the capacity to be reset (entrained) to environmental stimuli, and can communicate entrainment signals to other tissues

(Guilding and Piggins, 2007). Semi-autonomous oscillators are populations of cells that can oscillate autonomously, but only with input from the master circadian pacemaker to synchronize these rhythms to a single rhythmic output within the tissue (Guilding and Piggins, 2007), whereas slave oscillators are independently arrhythmic tissues, but possess the capability to produce a rhythmic output entirely dependant on input from a master circadian pacemaker (Balsalobre, 2002, Reppert and Weaver, 2002, Guilding and Piggins, 2007).

Clock gene expression has been widely documented in a number of regions of the mammalian brain outside of the SCN, for example the hypothalamic nuclei (Wyse and Coogan, 2010), the VTA (McClung et al., 2005, Hampf et al., 2008, Wang et al., 2009), the hippocampus (Wakamatsu et al., 2001, Lamont et al., 2005, Chaudhury et al., 2008) and the amygdala (Lamont et al., 2005, Wang et al., 2009), and in the peripheral tissues; the liver, heart and skeletal muscle (Zylka et al., 1998, Reppert and Weaver, 2001, Storch et al., 2002). The peripheral tissues have been shown to contain circadian clocks, and clock gene expression has been shown to be 3-9 hours delayed in the peripheral clocks in comparison to the SCN (Balsalobre et al., 1998, Reppert and Weaver, 2001, Balsalobre, 2002). The peripheral oscillators are thought to be entrained to the light-dark cycle through a combination of neural and humoral output signals from the SCN (Oishi et al., 1998, Ueyama et al., 1999, Balsalobre et al., 2000, Reppert and Weaver, 2001, Keller et al., 2006), including the hormones melatonin and cortisol, which have been implicated in the entrainment of the peripheral oscillators (Keller et al., 2006, Wiechmann and Summers, 2008). The role of the peripheral oscillators in the regulation of biological processes is thought to be in receiving signals from the SCN, which then coordinate the expression of clock controlled genes, which in turn are thought to regulate more local rhythms in physiology and behaviour (Reppert and Weaver, 2001, Balsalobre, 2002, Reppert and Weaver, 2002).

Evidence suggests that there may be slight differences in the molecular clockwork at the peripheral level in comparison to the master pacemaker. For example, whilst NPAS2 is able to compensate for the loss of functional CLOCK protein in the SCN, such that SCN rhythmicity is maintained, NPAS2 alone is not capable of maintaining circadian rhythmicity in the absence of CLOCK in the peripheral oscillators of the

liver and lung (DeBruyne et al., 2007a, DeBruyne et al., 2007b). Conversely, in the forebrain, NPAS2 is believed to function in the place of CLOCK (Reick et al., 2001). Additionally, in homozygous clock mutant mice, *BMAL1* expression is elevated in the peripheral tissues, whilst its expression is dampened in the SCN (Oishi et al., 2000, Reppert and Weaver, 2001).

More recently, the rhythmic expression of clock genes in the peripheral oscillators of human tissues, including peripheral blood mononuclear cells, fibroblasts, oral mucosa and hair follicle cells, have been utilised as a method of assessing human circadian clock functioning. Circadian oscillations of clock gene expression have been documented in the oral mucosa and skin cells of healthy human subjects (Bjarnason et al., 2001). In both tissues *CLOCK* was expressed at a constant level with no rhythmicity across the circadian cycle (Bjarnason et al., 2001), which is in accordance with the constitutive expression of *CLOCK* observed in the rodent SCN (Gekakis et al., 1998, Guilding and Piggins, 2007). On the other hand, *BMAL1* and *PER1* expression was significantly rhythmic in both the oral mucosa and skin tissue, and a significant rhythm of *CRY1* expression was detected in the oral mucosa (Bjarnason et al., 2001). Furthermore measurement of peripheral clock gene expression in the oral mucosa has been employed to assess the impact upon the circadian clock of evening blue light, which is of the wavelength that is within the range of the photopigment melanopsin contained within the retinal ganglion cells (Cajochen et al., 2006). Here it was documented that blue light rapidly induced *PER2* expression, and hence the peripheral oscillator of the oral epithelial cells is responsive to the dominant Zeitgeber light (Cajochen et al., 2006). Circadian expression of the clock genes: *BMAL1*, *PER1*, *PER2*, *REV-ERB α* , *DEC2* and *DBP* have been observed in fibroblast cell lines originating from human skin biopsies (Yang et al., 2009). Furthermore, a positive linear correlation has been demonstrated between the period length of fibroblast gene expression and human physiological period length as measured by melatonin concentrations (Pagani et al., 2010). Studies have also demonstrated rhythmic expression of the circadian clock genes in the peripheral blood mononuclear cells (Takata et al., 2002, Boivin et al., 2003, Teboul et al., 2005). Teboul et al., 2005 reported oscillations of *BMAL1* and *PER2* expression, almost in phase with each other, and relatively constant expression of *REV-ERB α* across the circadian cycle. Additionally, two distinct molecular

chronotypes were documented based upon two groups of subjects that exhibited differing phases of clock gene expression (Teboul et al., 2005). More recently circadian clock gene expression has been observed in the human hair follicle cells obtained from the head or the chin (Akashi et al., 2010). *PER2* and *DBP* expression was reported to exhibit low amplitude oscillations, and the expression of *BMAL1* and *NPAS2* exhibited only a slight circadian oscillation (Akashi et al., 2010). The most robust and significant circadian rhythms of expression were observed for *PER3*, *REV-ERB α* , and *REV-ERB β* (Akashi et al., 2010). Furthermore, the peak expression of *PER3*, *REV-ERB α* , and *REV-ERB β* was positively correlated with average wakefulness time as measured by actigraphy, and it was therefore concluded that the circadian rhythms of clock gene expression in the hair follicle cells correspond to the human behavioural rhythm (Akashi et al., 2010).

Entrainment of the circadian clock

The dominant Zeitgeber that entrains the mammalian circadian clock is the light-dark cycle (Guilding and Piggins, 2007). Light is detected via the retina and photic information is conveyed to the SCN via the glutamatergic retinohypothalamic tract (RHT) which arises from widely distributed retinal ganglion cells (Moore et al., 1995, Reppert and Weaver, 2001, Guilding and Piggins, 2007). Glutamate is the main neurotransmitter of the RHT and substance P and pituitary adenylate cyclase-activating peptide (PACAP) modulate entrainment (Ebling, 1996, Chen et al., 1999, Hamada et al., 1999, Reppert and Weaver, 2001). Glutamate is released as a consequence of photic stimulation and activates calcium-dependent signalling pathways (Reppert and Weaver, 2001, figure 1.3), and the extracellular-signal-regulated kinase (ERK) pathway has been implicated, which upon activation will result in the phosphorylation of cAMP response element binding protein (CREB) (Kornhauser et al., 1996, Obrietan et al., 1998, Coogan and Piggins, 2003, Dziema et al., 2003, Lee et al., 2003, Coogan and Piggins, 2004, Antle et al., 2005, Guilding and Piggins, 2007). Phosphorylated CREB promotes transcription by binding to cAMP response elements (CRE) present in target genes, including *PER1* and *PER2* (Travnickova-Bendova et al., 2002, Guilding and Piggins, 2007). The circadian clock is able to regulate its responsiveness to inputs at specific points of the circadian cycle, through regulation of CREB phosphorylation whose light induction is limited

to a nocturnal zone of sensitivity (Ginty et al., 1993, Ding et al., 1997, Reppert and Weaver, 2001). Additionally, the immediate early genes *c-FOS*, *FOSB* and *JUNB* also possess CRE sequences in their promoter regions and therefore are transcribed in response to night-time light pulses, in a similar manner to *PER1* and *PER2* (Greenberg et al., 1992, Perez-Albuerne et al., 1993, Guilding and Piggins, 2007). *c-FOS* induction frequently occurs in parallel with a phase shift in response to various stimuli, however its induction in the SCN is not required for phase-shifting responses to light (Colwell et al., 1993, Weber et al., 1995, Honrado et al., 1996, Reppert and Weaver, 2001).

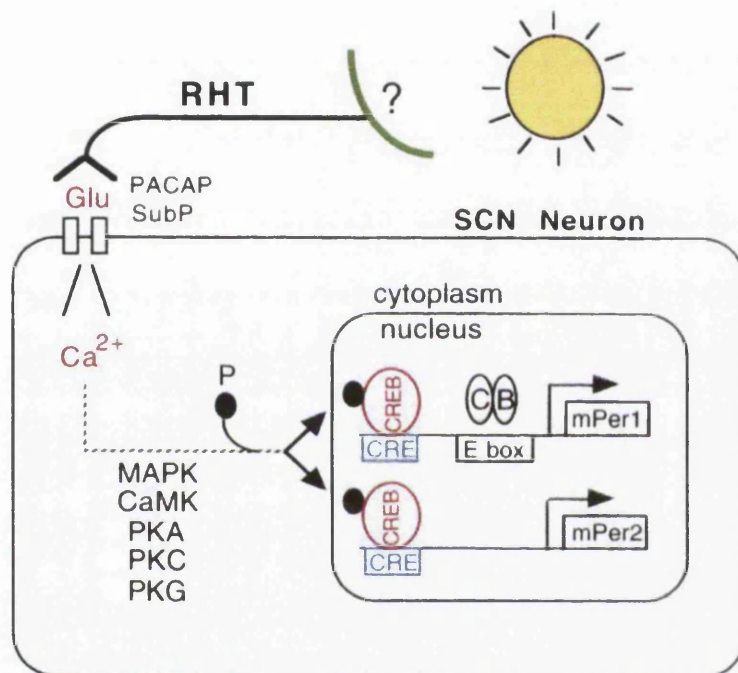

Figure 1.3. The light input pathway to the SCN clockwork. Highlighted in red = elements known to be important for light activation of pathways involved in the regulation of behaviour. CLOCK = C, BMAL1 = B. Light stimulates glutamate (Glu) release from terminals of the RHT, which innervates the retinorecipient SCN. Glutamate differentially activates calcium-dependent signalling pathways; substance P (SubP) and PACAP released from the RHT modulate glutamate action. cAMP response element-binding protein (CREB) is phosphorylated by the kinases; MAP kinase (MAPK), protein kinase A (PKA), protein kinase C (PKC), protein kinase G (PKG) and CREB activates *mPER1* and *mPER2* transcription via CRE sequences (blue) of the PER gene promoter regions (Reppert and Weaver, 2001).

Key components of the circadian system are the rhythmic output signals from the SCN, which are responsible for entrainment of the peripheral oscillators. The adrenal glucocorticoid stress hormone cortisol plays a key role in the hypothalamic-pituitary-adrenal (HPA) axis (Keller et al., 2006), but is also an important output of the master circadian pacemaker, and its secretion is regulated by output pathways of the SCN involving AVP and corticotropin-releasing hormone (Keller et al., 2006). Cortisol displays a circadian rhythm in its secretion consisting of an increase just before waking up in the morning, a peak within an hour of waking and then a decline over the rest of the 24-hour day (Van Someren and Riemersma-Van Der Lek, 2007). Environmental light exposure directly after awakening increases the amplitude of the morning peak, and so it can be postulated that a regular precise cortisol rhythm would be promoted by regular early morning light exposure (Van Someren and Riemersma-Van Der Lek, 2007). Cortisol is thought to be involved in the regulation of circadian rhythms (Keller et al., 2006) in particular the entrainment of the peripheral oscillators (Van Someren and Riemersma-Van Der Lek, 2007). Upon release from the adrenal glands cortisol binds predominantly with mineralocorticoid receptors (MRs) and to a lesser extent glucocorticoid receptors (GRs) (Keller et al., 2006). The MRs are particularly involved in regulation of the evening-night nadir of the circadian rhythm (Kalman and Spencer, 2002, Otte et al., 2003, Young et al., 2003, Keller et al., 2006), whereas the GRs are implicated in the feedback changes when cortisol levels are high, for example in response to stress, or during the peak of the circadian rhythm (Keller et al., 2006).

The pineal hormone melatonin is synthesised in the pinealocytes from tryptophan, which is taken up from the blood (Wiechmann and Summers, 2008) and the secretion of melatonin itself exhibits a clear circadian rhythm, with peak plasma levels usually between 02:00 and 03:00 am (Arendt and Skene, 2005, Pandi-Perumal et al., 2005). Input originating from the endogenous circadian pacemaker in the SCN via GABAergic mechanisms is thought to regulate melatonin synthesis (Reppert and Weaver, 2001). Furthermore input from the master pacemaker is essential for the synchronization of the circadian rhythm of melatonin to the light-dark cycle and the persistence of the rhythm (Macchi and Bruce, 2004). Melatonin also plays a role in mediating various circadian activities throughout the body through its antioxidant properties (Wiechmann and Summers, 2008). These include regulation of

reproductive capacity, hormone secretion, immune responsiveness, daily rhythms of activity and entrainment of sleep/wake cycles (Wiechmann and Summers, 2008). The circadian rhythm of melatonin synthesis is closely linked to the sleep rhythm as demonstrated by the nocturnal onset of melatonin secretion, which usually occurs 2 hours in advance of the individuals habitual bedtime, and correlates with evening sleepiness and the sleep promoting effect of exogenous melatonin (Tzischinsky et al., 1993, Zhdanova et al., 1996, Zhdanova and Tucci, 2003, Pandi-Perumal et al., 2005). Melatonin is believed to have a strong entraining influence on the master circadian clock through its ability to directly feed back to the SCN (Pierce et al., 2008, Reppert and Weaver, 2001), where it is believed to have two main effects upon the SCN, acute neuronal inhibition and phase-shifting (Liu et al., 1997). Melatonin mediated inhibition of SCN neuronal firing is thought to promote sleep, via the activation of GABAergic mechanisms in the SCN (Golombek et al., 1996, Tenn and Niles, 1997, Pandi-Perumal et al., 2005). The firing rate of SCN neurons normally increases throughout the day, reaching a maximum in the evening, prior to the onset of melatonin production and this increase in electrical activity has been linked to the wakefulness-promoting effect of the circadian pacemaker (Pandi-Perumal et al., 2005). Two subtypes of human G-protein coupled receptors (MT₁ and MT₂) have been implicated in the sleep promoting and circadian effects of melatonin. MT₁ mRNA is expressed predominantly in the SCN, whereas MT₂ mRNA is expressed in not only the SCN, but other areas of the CNS and the periphery (Reppert et al., 1988, Reppert et al., 1996, Pandi-Perumal et al., 2005). Both receptors are capable of mediating phase shifts (Reppert and Weaver, 2001) whilst just the SCN MT₁ receptors are related to amplitude of SCN circadian rhythmicity, the MT₂ receptors are thought to be involved in entrainment of circadian rhythms (Liu et al., 1997, Hunt et al., 2001, Pandi-Perumal et al., 2005).

Interaction of the circadian and catecholaminergic systems

The monoaminergic neurotransmitters, including dopamine and noradrenaline are involved in the regulation of a number of behaviours and physiological processes. The monoaminergic neurons are implicated in an arousal circuit involving noradrenergic neurons in the locus coeruleus, dopaminergic neurons in the ventral periaqueductal grey, serotonergic neurons in the dorsal raphe nucleus and the

histaminergic neurons of the tuberomammillary nucleus, which project to the cerebral cortex (Mitchell and Weinshenker, 2010). These monoaminergic neurons receive input from the orexin neurons, which play a key role in the transitions between sleep stage and wakefulness (Lin et al., 1999, Carter et al., 2009, Mitchell and Weinshenker, 2010), and via the dorsal medial hypothalamus this system interacts with the SCN (Aston-Jones et al., 2001, Pace-Schott and Hobson, 2002). The noradrenergic system is also associated with the regulation of cortical functions including attention, alertness and vigilance (Biederman and Spencer, 1999). Whereas the neurotransmitter dopamine is involved in the regulation of mood (Nestler and Carlezon, 2006) and is also key to the brains reward system, with dopaminergic input from the ventral tegmental area (VTA) to the nucleus accumbens being involved in natural reward as well as the reward in response to drugs of abuse (Wise, 1998, Koob and Le Moal, 2001, Nestler and Carlezon, 2006). Characteristically many drugs of abuse will increase dopaminergic neurotransmission in the nucleus accumbens, which has been attributed to the rewarding effects of these drugs (Wise, 1998, Koob and Le Moal, 2001).

Furthermore, the extracellular concentrations of many neurotransmitters are known to exhibit a circadian rhythm in various brain regions, including dopamine and its metabolites in the striatum and nucleus accumbens (Smith et al., 1992, Paulson and Robinson, 1994, Paulson and Robinson, 1996, Castaneda et al., 2004) and noradrenaline in the SCN (Cagampang et al., 1994) and the pineal gland (Drijfhout et al., 1996). Furthermore, fibres containing tyrosine hydroxylase, the rate-limiting enzyme for dopamine biosynthesis, which hence has effects upon noradrenaline levels, have been located in the medial SCN (Cagampang et al., 1994). Many of these rhythms of extracellular neurotransmitter concentration appear to be endogenously regulated by the master circadian pacemaker, since they persist under constant conditions (Barassin et al., 2002, Castaneda et al., 2004). The catecholaminergic systems have also been implicated in regulation of the circadian system, with the dopamine system being involved in the entrainment of the master pacemaker, in particular the function of dopamine neurons in the regulation of light input in the retina (Witkovsky, 2004, McClung et al., 2005) and the essential role of D1 dopamine receptors in the synchronization of the SCN during prenatal development (Ferguson et al., 2000). Noradrenaline is known to influence

spontaneous activity and photic responsiveness of the SCN neurons (Nishino and Koizumi, 1977, Liou et al., 1986, Rosenwasser, 1996), and it has been proposed as an entrainment signal originating from the SCN to entrain the peripheral oscillator of the pineal gland (Wongchitrat et al., 2009), since it has been observed in rodents that the expression of the clock genes *PER1* and *CRY2* is regulated by nocturnal noradrenaline release in the pineal gland (Fukuhara et al., 2000, Simonneaux et al., 2004). Noradrenaline is further implicated in the circadian system, by its regulation of melatonin production (Wongchitrat et al., 2009). Nocturnal noradrenaline release in the pineal gland causes an upregulation of arylalkylamine N-acetyltransferase (AA-NAT), the enzyme responsible for acetylation of serotonin, which along with methylation by hydroxyindole-O-methyltransferase, results in the production of melatonin (Wongchitrat et al., 2009). Since melatonin plays a key role in mediating various circadian activities including the sleep-wake cycle (Reppert and Weaver, 2001, Pierce et al., 2008, Wiechmann and Summers, 2008), it can be postulated that noradrenaline levels could affect these processes also. Furthermore associations between altered behaviours that are controlled by these neurotransmitter systems and perturbations to the circadian system have been observed. For example, learning and memory are influenced by sleep and circadian disturbance (Dijk et al., 1992, Peigneux et al., 2004, Ellenbogen et al., 2006, Wright et al., 2006, Ruby et al., 2008, Wang et al., 2009). Moreover, the circadian rhythm of rodent locomotor activity is significantly disrupted by dopamine depletion due to a 6-hydroxydopamine lesion of the VTA (Isobe and Nishino, 2001), and dopamine β -hydroxylase knockout mice do not produce noradrenaline, and exhibit perturbed sleep and arousal rhythms (Mitchell and Weinshenker, 2010).

Interactions of the monoaminergic systems and the circadian clock are observed on the molecular level also. The rodent monoamine oxidase A (MAOA) promoter has been shown to be subject to regulation by BMAL1, NPAS2 and PER2 in the VTA, with BMAL1 being shown to bind the mMAOA promoter directly with circadian rhythmicity (Hampp et al., 2008). The dopamine receptors have also been shown to influence clock gene expression, with treatment of the striatal neurons with a D1 receptor agonist causing an upregulation of the expression of the clock genes *PER1*, *CLOCK*, *NPAS2* and *BMAL1*, whereas a D2/D3 receptor agonist suppressed *CLOCK* and *PER1* expression (Imbesi et al., 2009). Furthermore, daily dopaminergic

activation of the D2 receptors is thought to be essential to the rhythmic expression of PER2 in the rodent dorsal striatum (Hood et al., 2010). A mechanism by which the monoamines may interact with circadian clock genes could be through the cAMP system (Uz et al., 2005), since the dopamine receptors are known to affect cAMP levels (Andersen et al., 1990). Furthermore, the phosphorylation of mitogen activated protein kinase (MAPK) and cAMP response element binding protein (CREB) is stimulated by both dopamine (Yan et al., 1999) and noradrenaline (Tamotsu et al., 1995, Thonberg et al., 2002), and a number of clock genes are known to possess CRE binding sequences (Takahata et al., 2000, Travnickova-Bendova et al., 2002).

1.2 Circadian Rhythms in Psychiatry

Circadian rhythm disturbance is evident in psychiatry, and is observed in disorders including schizophrenia, unipolar depression and bipolar depression (Atkinson et al., 1975, Wehr et al., 1983, Madjirova et al., 1995, Rausch et al., 2003, Yang et al., 2009, Gouin et al., 2010, Lamont et al., 2010). The social Zeitgeber theory states that mood disorders can develop as a result of circadian rhythm disturbance, where circadian rhythm disruption may arise from life stresses, which perturb normal social routines and sleep/wake cycles, resulting in changes in biological rhythms and mood (McClung, 2007). This hypothesis is supported by evidence for the comorbidity of the circadian rhythm disorders familial advanced sleep phase syndrome (FASPS) and delayed sleep phase syndrome (DSPS) with depression and anxiety (Shirayama et al., 2003, Xu et al., 2005, Hamet and Tremblay, 2006, McClung, 2007, Barnard and Nolan, 2008). Furthermore, therapies that stabilise or alter the circadian rhythm are successful in improving some of the symptoms of psychiatric illness (e.g. Wu and Bunney, 1990, Leibenluft and Wehr, 1992, Barbini et al., 1998, Benedetti et al., 2001, Gould and Manji, 2005, Yin et al., 2006, Lamont et al., 2010).

Deficits in the sleep-wake cycle in psychiatry are widely documented, with polysomnographic and actigraphic studies revealing alterations in a number of circadian and sleep parameters in association with bipolar disorder, depression and schizophrenia. Insomnia and hyperinsomnia, early morning awakening, reduced sleep efficiency and most commonly reported altered REM sleep latency have been widely observed in bipolar disorder (Boivin, 2000, Lamont et al., 2010). The sleep-

wake cycle also appears to play a role in the regulation of mood in bipolar disorder, as demonstrated by the association between the switch from mania/hypomania to depression or euthymia during or after sleep, whereas the switch from depression to mania/hypomania tends to occur after a period of wakefulness (Feldman-Naim et al., 1997, Voderholzer et al., 2002, Lamont et al., 2010). Furthermore disturbances in the sleep-wake cycle, particularly sleep restriction, appears to increase the risk of a manic/hypomanic episode the following day (Leibenluft et al., 1996, Harvey, 2008, Boyce and Barriball, 2010, Lamont et al., 2010). Conversely, depression is associated with increased duration of sleep (Wehr, 1989, Leibenluft et al., 1996, Lamont et al., 2010). In unmedicated schizophrenics, polysomnography demonstrated poor sleep initiation and consolidation, impaired sleep homeostasis expressed as low levels of slow wave sleep and shortened REM sleep latency (Boivin, 2000, Chouinard et al., 2004, Lamont et al., 2010). Insomnia and a shorter REM stage latency after sleep onset has also been observed among depressed patients (Kupfer and Foster, 1972, Riemann et al., 2001), and a recent study reported that the severity of major depression correlates with circadian disturbance, therefore the greater the phase delay of the pacemaker relative to the timing of sleep, the more severe the symptoms of the disorder (Emens et al., 2009, de Bodinat et al., 2010).

The circadian rhythm of activity can be described by designation of chronotype, which refers to an individual's innate preference to be active and alert either in the morning or the evening, accordingly known as "morningness" or "eveningness" (Horne and Ostberg, 1977). The intrinsic period of the circadian clock is thought to be linked to diurnal preference (Duffy et al., 2001, Johansson et al., 2003) and longer free-running circadian periods are associated and possibly causative of later phases of behaviour under the normal light-dark cycle, whilst shorter periods are associated with earlier phases (Brown et al., 2008). Extreme diurnal preference has been linked with psychiatric illness, with associations between eveningness and both schizophrenia and bipolar disorder, and greater severity and increased cycling of mood in bipolar disorder (Mansour et al., 2006, Lamont et al., 2010).

A link of both depression and bipolar disorder with circannual rhythms, which are the yearly seasonal patterns observed in nature, has been widely documented (Boyce, 1985, Westrin and Lam, 2007, Boyce and Barriball, 2010). Depression in seasonal

affective disorder (SAD) is associated with the winter months, and a phase delay is the proposed circadian deficit responsible for the symptoms, as demonstrated by delayed temperature and melatonin secretion rhythms (Khalsa et al., 2000, Boyce and Barriball, 2010). An increase in the number of bipolar episodes of depression or hypomania have been observed during certain times of the year, which it is thought to be due to failure in adaptation to the seasonal change in day length resulting in internal disorganisation of the circadian system, which causes mood problems (Boyce, 1985, Westrin and Lam, 2007, Boyce and Barriball, 2010).

The measurement of core body temperature and blood pressure both of which exhibit clear circadian rhythmicity, has been utilised as a key indicator of circadian clock functioning. An elevation in nocturnal body temperature has been associated with depression (Rausch et al., 2003, Gouin et al., 2010). Disturbance in core body temperature, blood pressure and pulse has been observed in schizophrenia (Madjirova et al., 1995, Lamont et al., 2010), and a shortened or lengthened circadian period has been associated with bipolar disorder (Atkinson et al., 1975, Wehr et al., 1983, Yang et al., 2009).

As previously described, the molecular basis of the circadian clock consists of a number of transcriptional/translational feedback loops of circadian clock genes and their protein products (Boyce, 1985, Westrin and Lam, 2007, Boyce and Barriball, 2010). Hence there have been a number of studies that have aimed to assess abnormalities in these clock components in psychiatric illness, including measurement of clock gene expression, screening of single nucleotide polymorphisms (SNPs), and investigation into the effects upon behaviour in rodent models deficient in one or more of these clock components, which will now be described.

A study of clock gene expression at a specific single time-point in the peripheral blood mononuclear cells revealed an upregulation of *mCLOCK*, *mBMAL1* and *mPER1* expression in individuals with a history of unipolar depression in comparison to healthy controls, and levels of *mCLOCK* were found to predict history of the disorder (Gouin et al., 2010). Levels of *mCRY2* have been assessed in bipolar depression before and after sleep deprivation, a key trigger for bipolar episodes

(Lavebratt et al., 2010b). Lowered levels of *mCRY2* at a single time-point in the peripheral blood mononuclear cells have been associated with bipolar disorder, and sleep deprivation was shown to prompt an increase in *mCRY2* in the control subjects, but not in bipolar patients (Lavebratt et al., 2010b). Studies of gene expression at a single time-point are however limited by the inability to detect phase alterations in the rhythms of clock gene expression. Microarray analysis of post-mortem brain tissue has revealed a dampening of *mPER1* expression in schizophrenia (Aston et al., 2004, Lamont et al., 2010). Clock gene expression in the fibroblasts of bipolar patients has been studied, and although the rhythmic expression of *mBMAL1*, *PER1*, *mPER2*, *mREV-ERB α*, *mDEC2* and *mDBP* was not significantly altered in bipolar disorder, there were trends towards reduced expression of *mDBP* and *mDEC2*, reduced phosphorylation of GSK3β and reduced amplitude of the *BMAL1* expression rhythm in association with the disorder (Yang et al., 2009). *DEC2* and *DBP* have been proposed to play a role in the core circadian clock (Yamaguchi et al., 2000b, Honma et al., 2002, Yang et al., 2009), although they are also known as clock controlled genes that could effect downstream gene regulation (Ripperger et al., 2000, Noshiro et al., 2007, Yang et al., 2009). It could be postulated that such alterations in the expression of core clock components could have downstream effects upon clock controlled processes, and hence contribute to the pathogenesis of the disorder.

Associations of genetic variations in the core clock genes and both psychiatric and sleep disorders have been extensively investigated. Numerous studies have revealed an association between the rs1801260 C/T SNP in the core circadian clock gene *CLOCK* and psychiatric illness. The SNP has been found to be associated with a higher number of bipolar episodes in bipolar patients (Benedetti et al., 2003, McClung, 2007), although this has not been replicated in other studies (Desan et al., 2000, Johansson et al., 2003). Greater insomnia in bipolar patients and individuals undergoing antidepressant treatment has also been associated with the *CLOCK* SNP (Serretti et al., 2003, Serretti et al., 2005, McClung, 2007). An association between the C allele of the SNP and schizophrenia has been reported and it has been hypothesised that the *CLOCK* SNP along with aberrant dopaminergic transmission to the SCN could underlie the pathophysiology of the disorder (Takao et al., 2007, Lamont et al., 2010). The same SNP has also been implicated in diurnal preference,

with reports of an association between the C allele and evening preference (Katzenberg et al., 1998, Mishima et al., 2005), although no association has also been reported (Robilliard et al., 2002). Since this SNP is located in the 3' flanking region of the *CLOCK* gene it can be postulated that it could effect processes integral in the regulation of translation efficiency, mRNA stability, and polyadenylation signals, (McClung, 2007).

Polymorphisms in other clock genes have also been associated with psychiatric illness including polymorphisms in *BMAL1*, *PER3* and *TIMELESS*, which have been associated with bipolar disorder (Mansour et al., 2006, Nievergelt et al., 2006, Yang et al., 2009). It has also been suggested that the interaction of several clock gene polymorphisms may be necessary to disrupt circadian gene function (Lavebratt et al., 2010b, Rosenwasser, 2010) as demonstrated by reports of the interaction of 3 clock gene polymorphisms in predicting bipolar disorder (Shi et al., 2008, Gouin et al., 2010). In schizophrenia associations with polymorphisms in *PER1*, *PER3* and *TIMELESS* have been reported (Aston et al., 2004, Mansour et al., 2006, Rosenwasser, 2010) and polymorphisms in *PER2*, *NPAS2* and *BMAL1* have been associated with depression in SAD (Johansson et al., 2003, Partonen et al., 2007, Lavebratt et al., 2010a).

Moreover, studies using rodent models for bipolar disorder have revealed circadian genes are candidate genes for mania and psychosis, including *BMAL1*, *CRY2*, *GSK3 β* , *CKI δ* , and *DBP* (Niculescu et al., 2000, Ogden et al., 2004, Yang et al., 2009). Also, the *CRY1* gene is located near a linkage hotspot for schizophrenia on chromosome 12q24, and it is therefore suspected to be involved in the disorder (Peng et al., 2007, Lamont et al., 2010). Furthermore its expression impacts upon the activity of psychoactive drugs (Uz et al., 2005, Lamont et al., 2010).

Not only have the molecular properties of the circadian system been implicated in psychiatric disorders, but so have some of the key outputs of the master circadian pacemaker. Much research has addressed the role of potential abnormalities in the HPA-axis mediated response to stress via cortisol reactivity in psychiatric illness (Hong et al., 2003, Blomqvist et al., 2007, Sondeijker et al., 2007, Lackschewitz et al., 2008, Randazzo et al., 2008, Hastings et al., 2009). However, the potentially

compromised role of cortisol in the circadian system has also been under scrutiny, and perturbed circadian profiles of cortisol secretion have been associated with psychiatric illness. Studies of the cortisol rhythm in depression have reported a wide range of alterations including an association of an earlier, elevated or reduced period of nadir with depression (Halbreich et al., 1985, Pfohl et al., 1985, Yehuda et al., 1996, Keller et al., 2006). Furthermore, elevated evening cortisol levels have been associated predominantly with the psychotic symptoms of depression, and not the disorder generally (Rothschild et al., 1982, Keller et al., 2006) and it has been speculated that this could be due to reduced feedback inhibition of HPA axis activity, involving the mineralocorticoid receptors, due to their proposed role in the regulation of the HPA axis during the evening hours (Keller et al., 2006). Flattened diurnal rhythms of cortisol secretion have been demonstrated in remitted bipolar disorder, with greater disturbance of the rhythm being associated with increased number of previous episodes (Havermans et al., 2010). Cortisol hypersecretion in bipolar patients during both depressed and hypomanic phases has been documented, but to the contrary there was no alteration in overall cortisol level detected in remitted bipolar patients (Cervantes et al., 2001). Other studies have reported advanced phases of cortisol secretion in bipolar disorder (Beck-Friis et al., 1985b, Linkowski et al., 1994, Lamont et al., 2010). The findings of studies of diurnal cortisol profiles in schizophrenia are mixed. Basal HPA-axis functioning as measured by overall cortisol concentration throughout the day has been reported as normal in schizophrenia, whilst other studies have reported an association of normal diurnal cortisol concentrations with both medicated and unmedicated patients (Kemali et al., 1985, Gil-Ad et al., 1986, Van Cauter et al., 1991, Jiang and Wang, 1998, Hempel et al., 2010). To the contrary, heightened sensitivity of the HPA-axis as indicated by a steeper decrease in cortisol concentration during the day has been observed in schizophrenic patients (Hempel et al., 2010) as well as increased cortisol levels during the day of unmedicated schizophrenia patients (Monteleone et al., 1992, Ryan et al., 2004, Gunduz-Bruce et al., 2007, Hempel et al., 2010). It could be postulated that since the cortisol rhythm provides an entrainment signal from the SCN to the peripheral oscillators, any abnormalities in the cortisol rhythm could have implications for the synchronisation of the circadian system and consequently exert several physiological effects (Van Someren and Riemersma-Van Der Lek, 2007).

It is well documented that an abnormal circadian rhythm of melatonin secretion is demonstrated in psychiatric illness. A number of abnormalities in the circadian rhythm of melatonin have been associated with bipolar disorder, including a phase advance in the rhythm, reduced amplitude of the melatonin rhythm and greater sensitivity to light suppression of melatonin (Beck-Friis et al., 1985b, Souetre et al., 1989, Srinivasan et al., 2006, Lamont et al., 2010). Anomalies in the melatonin rhythm have also been documented in depression, particularly, lower concentrations of melatonin have been reported and delayed melatonin release has been observed in depressed patients (Parry and Newton, 2001, Macchi and Bruce, 2004, Gouin et al., 2010), whilst the melatonin rhythm has been shown to be unaltered in depression by another study (Waldhauser et al., 1993). Additionally it has been demonstrated that plasma melatonin levels increase with improvement of clinical symptoms in patients suffering from major depressive disorder who are undergoing antidepressant treatment (Thompson et al., 1985, Golden et al., 1988, Pandi-Perumal et al., 2005). It is hypothesised that this occurs through photoperiodic dysregulation (Partonen, 1998, Macchi and Bruce, 2004), which is more likely to be associated with the phase of the melatonin rhythm relative to the day-night cycle rather than the amplitude or absolute level of melatonin (Lewy et al., 1987a, Macchi and Bruce, 2004). Several studies have reported perturbations of the melatonin rhythm in schizophrenia also, including a significantly longer period of the melatonin rhythm and a dampened nocturnal increase in melatonin secretion (Monteleone et al., 1992, Macchi and Bruce, 2004, Wulff et al., 2006). Due to the strong entraining influence melatonin has upon the master circadian clock, and its potential role in the entrainment of the peripheral oscillators (Wiechmann and Summers, 2008), it could be postulated that any abnormalities in the melatonin rhythm could impact particularly on the sleep-wake cycle, but also affect a number of other behavioural and physiological processes, thus contributing to the pathophysiology of psychiatric illness.

Various therapies for psychiatric illness have been implicated in some form of modulation of the circadian clock, including pharmacological treatments, bright light exposure and implementing enforced sleep patterns. Lithium is a pharmacological mood stabilizer predominantly used for the treatment of bipolar disorder, which appears to interact with the circadian clock in a number of ways. Firstly it was shown to reduce sensitivity to light suppression of melatonin in controls subjects (Hallam et

al., 2005, Lamont et al., 2010). Secondly it lengthens the circadian period in rodents (LeSauter and Silver, 1993, Lamont et al., 2010), and also in SCN neuronal firing of cultured cells in a dose dependant manner (Abe et al., 2000, Lamont et al., 2010). It has been proposed that one of the mechanisms of action of lithium could be through the inhibition of GSK3 β , as GSK3 β does function as a regulator of the circadian clock (Gould and Manji, 2005, Iitaka et al., 2005, Lamont et al., 2010). *PER2* and REV-ERB α have both been shown to be modulated by lithium and GSK3 β , with knockdown of both lithium and GSK3 β causing a lengthening of the period of *PER2* expression (Kaladchibachi et al., 2007, Lamont et al., 2010). Furthermore GSK3 β affects the nuclear entry of PER2 (Iitaka et al., 2005, Lamont et al., 2010). Via the inhibition of GSK3 β , lithium dampens REV-ERB α expression (Yin et al., 2006, Lamont et al., 2010). Moreover, it is thought that other mood stabilizers such as valproate may inhibit GSK3 β , and other antidepressant therapies including serotonergic and dopaminergic agents may target GSK3 β (Gould and Manji, 2005, Lamont et al., 2010), hence implicating it in the pharmacological treatment of a wide range of psychiatric disorders.

Light therapy and sleep deprivation have been shown to be efficacious in treating both depression in SAD and non-seasonal depression, and bipolar disorder during the depressive phase (Wehr et al., 1979, Wu and Bunney, 1990, Leibenluft and Wehr, 1992, Barbini et al., 1998, Benedetti et al., 2001, Lamont et al., 2010). Bright light therapy normally consists of 10000 lux light every morning post waking, for 30-60 minutes (Eastman et al., 1998, Lewy et al., 1998, Terman et al., 1998, Desan and Oren, 2001, Glickman et al., 2006). Morning light is more efficacious if timed appropriately to the melatonin rhythm, which in most clinical situations is approximated by chronotype (Terman, 2007). Dawn awakening therapy has also been used to treat seasonal depression, consisting of 300 lux light at the end of the sleep interval (Terman et al., 1989, Terman, 2007). Dawn simulation therapy appears to be as effective at treating seasonal depression as post awakening bright light therapy (Terman and Terman, 2006, Terman, 2007). Light therapy has also shown some effectiveness in the treatment of non-seasonal depression (Goel et al., 2005, Terman, 2007). However, mild seasonality, with depressive episodes occurring throughout the year but with increased prevalence during the winter months, has been reported for a considerable number of patients with non-seasonal depression

(Terman, 2007). Therefore it could be the mildly seasonal component in these cases that is responsible for the positive effects of bright light therapy (Terman, 2007). The effects of light treatment on bipolar disorder have been more mixed, with some individuals showing improvement in clinical symptoms, whilst others are non-responsive, and it has been postulated that for it to be efficacious, a more sensitive dosing strategy would be required than that used for SAD (Leibenluft et al., 1995, Sit et al., 2007, Terman, 2007). However in combination with mood stabilizers and sleep deprivation, light therapy has shown some effectiveness in alleviating some of the symptoms of bipolar disorder (Benedetti et al., 2005, Benedetti et al., 2007). However light therapy does run the risk of triggering mood instability and a manic/hypomanic episode (Leibenluft et al., 1995, Leibenluft et al., 1996, Sit et al., 2007, Lamont et al., 2010). Phase advancing the sleep time was also found to be an effective treatment during the depressive phase of bipolar disorder (Wehr et al., 1979, Benedetti et al., 2001, Lamont et al., 2010).

Due to the observed abnormalities of the circadian rhythm of melatonin in depression and its effects upon the circadian clock, several studies have investigated the potential therapeutic use of exogenous melatonin in treating depression. Exogenous melatonin has been shown to exhibit a synchronising effect upon circadian rhythms, and has been used to facilitate adaptation to jet lag (Claustrat et al., 1992, Petrie et al., 1993, Dalton et al., 2000) and synchronizing the sleep-wake cycle of blind patients to an environmental light/dark cycle (Sack et al., 1991, Tzischinsky et al., 1992, Dalton et al., 2000). Due to its hypnotic effects, melatonin has been shown to improve sleep duration and sleep maintenance as well as re-synchronize the sleep-wake rhythm in individuals suffering from chronic sleep onset insomnia, delayed sleep phase syndrome, and in elderly patients who suffer from insomnia (MacFarlane et al., 1991, Brown, 1994, Haimov and Lavie, 1995, Haimov et al., 1995, Dalton et al., 2000). In patients with major depressive disorder, exogenous melatonin was shown to result in a 50% increase in sleep quality although there was no improvement in the clinical symptoms of depression (Dolberg et al., 1998). Similarly, in patients suffering from treatment-resistant depression melatonin treatment reduced insomnia, but with no effect upon mood (Dalton et al., 2000).

More recently the effects of agomelatine, a novel non-monoaminergic antidepressant

have been investigated in the treatment of depression. Agomelatine has been shown to resynchronize circadian disturbance in both nocturnal and diurnal rodent models of jet lag, DSPS, SAD and ageing, all of which displays depressive symptoms in association with circadian misalignment (Armstrong et al., 1993, Redman et al., 1995, Van Reeth et al., 2001, Wirz-Justice et al., 2005, de Bodinat et al., 2010). In rodents it was shown that the action of agomelatine was sustained in rats that had undergone a pinealectomy, but in SCN lesioned rodents, the resynchronizing action of agomelatine was abolished, thus indicating its action was independent of the pineal gland, but dependant upon the SCN (Morgan et al., 1994, Redman and Francis, 1998, Pitrosky et al., 1999, Jockers et al., 2008, de Bodinat et al., 2010). In humans the main effect of agomelatine upon the circadian system has been a phase advance in the body temperature rhythm without affecting the level of melatonin in healthy human subjects (de Bodinat et al., 2010). Clinical trials have shown that agomelatine is effective in treating major depression in mildly and severely ill patients, producing an improvement in sleep quality (Kennedy and Emsley, 2006, Lemoine et al., 2007, Olie and Kasper, 2007, Kennedy et al., 2008, Kasper and Hamon, 2009, Kasper et al., 2010, de Bodinat et al., 2010). The main actions of agomelatine are to bind to the M1 and M2 melatonin receptors, suppress cAMP formation, and mimic the actions of melatonin by inhibiting SCN neuronal firing (Ying et al., 1996, de Bodinat et al., 2010). However, agomelatine also blocks 5-HT_{2c} receptors, which are involved in the regulation of mood and the stress response (Giorgetti and Tecott, 2004, Millan, 2005, de Bodinat et al., 2010). The synthesis of serotonin is also under circadian regulation, and its pathways innervate the SCN and are implicated in the modulation of circadian rhythms (Kennaway and Moyer, 1998, Barassin et al., 2002, Varcoe and Kennaway, 2008, Cuesta et al., 2009, de Bodinat et al., 2010). Therefore, the action of agomelatine is thought to involve both agonistic effects upon the melatonin receptors and antagonist effects upon the 5-HT_{2c} receptors (de Bodinat et al., 2010).

1.3 Introduction to ADHD

Attention deficit-/hyperactivity disorder (ADHD) is a psychiatric condition that is characterised by inattention, hyperactivity, impulsivity and pervasiveness (Thome and Jacobs, 2004). ADHD can affect both children and adults (Biederman and Faraone, 2005). With the prevalence of ADHD in school aged children estimated at 3-7% (van West et al., 2009) it is the most commonly diagnosed cognitive and behavioural disorder in children (Banerjee et al., 2007). Approximately half of those individuals suffering from childhood ADHD are thought to carry over their symptoms into adulthood (Biederman and Faraone, 2005). Although there is an age-dependant decline in ADHD symptoms (by the age of 30-40 years, the majority of individuals diagnosed with childhood ADHD will no longer meet the criteria to be diagnosed with the disorder), some individuals will still demonstrate impairing symptoms (Biederman and Faraone, 2005). There are clear differences in the symptomology of ADHD between children and adults, with the hyperactive-impulsive symptoms decreasing in adulthood, and individuals who were diagnosed with the combined subtype in their childhood, being re-diagnosed with the inattentive subtype in adulthood (McGough and Barkley, 2004). This however could be due to the DSM-IV diagnostic criteria for hyperactive and impulsive behaviour not being suitable for detection of these symptoms in adulthood (McGough and Barkley, 2004). Furthermore in adulthood secondary problems of the disorder can develop, such as emotional instability, delinquency and drug addiction (Rosler et al., 2004).

ADHD is more commonly diagnosed in males, and this is thought to be predominantly due to gender differences between symptoms, with the symptoms in men being more obvious and so more easily diagnosed (Biederman and Faraone, 2004, Biederman and Faraone, 2005). Furthermore, men are thought to be at increased risk of environmental causes of the disorder, for example head injury (Faraone et al., 2000b, Biederman and Faraone, 2005). Low socioeconomic status and young age are also associated with ADHD (Scahill and Schwab-Stone, 2000, Doyle, 2004, Biederman and Faraone, 2005). In the UK DSM-IV is accepted as the formal diagnostic criteria for childhood ADHD, from which three subtypes of ADHD can be diagnosed; hyperactive-impulsive, inattentive and the combined

(McGough and Barkley, 2004, Biederman and Faraone, 2005). Diagnosis of adult ADHD requires both the use of DSM-IV criteria for diagnosis of retrospective childhood ADHD symptoms, along with additional scales including the Adult ADHD Self Report Scale (ASRS) and structured clinical interviews. There is evidence to suggest that the ADHD subtypes may not be manifestations of the same disorder but could be classed as completely separate conditions, although this hypothesis is still subject to debate (Faraone et al., 2000a, Smalley et al., 2000, Willcutt et al., 2000, McGough and Barkley, 2004).

It is widely believed that ADHD is a disorder that is caused by a dysfunction in the noradrenergic, dopaminergic and serotonergic systems, the neurotransmitters of which are intricately involved in the modulation of behaviours that are altered in ADHD (Comings, 2001, Biederman, 2005, Faraone and Khan, 2006, Chamberlain et al., 2007b, Nedic et al., 2010). This hypothesis is supported by a variety of evidence including that the targets of the pharmacological treatments for ADHD are components of these systems. The striatum contains a high degree of dopaminergic synapses and dopamine transporters, which are the targets of the stimulant methylphenidate, which is used to treat ADHD (Volkow et al., 1998, Volkow and Swanson, 2003, Biederman and Faraone, 2005). Rodents whose striatum is not intact exhibit hyperactivity and poor-inhibition control, which are characteristic behaviours of ADHD (Alexander et al., 1986, Biederman and Faraone, 2005). The spontaneously hypertensive rat is a well known rodent model for ADHD, and demonstrates abnormalities in dopamine release in the subcortical brain regions (Russell, 2000, Biederman and Faraone, 2005). The enzyme monoamine oxidase (MAO) is involved in the oxidative deamination of dopamine, noradrenaline and serotonin (Oreland, 2004, Nedic et al., 2010). An association has been reported of lowered platelet monoamine activity with the hyperactive, inattentive and impulsive symptoms of childhood ADHD patients (Nedic et al., 2010). Impairments in oxidative metabolism have also been observed in adult ADHD (Selek et al., 2008). Oxidative processes modulate brain function, for example the oxidant nitric oxide (NO) impacts upon catecholamine release, memory and learning and wakefulness (Akyol et al., 2004, Selek et al., 2008). Elevated levels of NO and decreased levels of the antioxidant superoxide dismutase (SOD) have been reported in adult ADHD, and

it was speculated that via its oxidative impact upon dopamine this could affect the pathways that control attention and physical activity (Selek et al., 2008).

The frontal subcortical circuits have been strongly implicated in the manifestation of the disorder. These brain regions are responsible for mediating executive functions such as inhibition, working memory, planning and sustained attention (Robbins et al., 1998, Miyake et al., 2000, Barkley et al., 2001, Castellanos and Tannock, 2002, Biederman and Faraone, 2005). A reduction in the volume of the front subcortical regions has been observed in ADHD by both structural and functional neuroimaging (Faraone and Biederman, 1998, Biederman and Faraone, 2005). Another study has revealed that in patients with ADHD there are significant patterns of frontal hypoactivity, affecting anterior cingulate, dorsolateral prefrontal, and inferior prefrontal cortices, and also related regions including the basal ganglia, thalamus, and portions of the parietal cortex (Dickstein et al., 2006, Ludolph et al., 2008b). The dopamine system in the midbrain, particularly the VTA and substantia nigra are thought to be important in the pathogenesis of ADHD (Viggiano et al., 2004), and PET scans have demonstrated a reduction in function of the brains dopamine reward circuit in ADHD (Volkow et al., 2010).

ADHD is a highly heritable disorder, with a 2 to 8 fold increase in the risk of developing the disorder in the parents and siblings of ADHD patients (Banerjee et al., 2007) and this is further demonstrated by twin and adoption studies (Faraone and Doyle, 2001, Faraone, 2004, Biederman and Faraone, 2005). It is also a multifactorial and heterogeneous condition (Nedic et al., 2010). Genetic variants of components involved in the dopaminergic, noradrenergic and serotonergic systems have been widely implicated in ADHD. A polymorphism in the dopamine D3 receptor gene (DRD3), which is thought to alter receptor incorporation in the membrane, has been found to be associated with impulsive behaviours that are characteristic of ADHD (Retz et al., 2003). The dopamine D4 receptor gene (DRD4) is prevalent in the frontal-subcortical networks, and dysregulation of this region has been associated with the ADHD (Faraone and Biederman, 1998, Biederman and Faraone, 2005). The exon III 7-repeat allele of DRD4 has been shown to cause an in-vitro dampened response to dopamine, and this variant has been associated with the disorder (Biederman and Faraone, 2005). A genetic variant of the dopamine 5

receptor gene (DRD5) has also been associated with the disorder (Lowe et al., 2004, Biederman and Faraone, 2005). Stimulant forms of ADHD medication have been shown to block the dopamine transporter (DAT) (Spencer et al., 2000, Biederman and Faraone, 2005) and reduced DAT binding has been demonstrated in adult ADHD (Dougherty et al., 1999, Dresel et al., 2000, Krause et al., 2000, Krause et al., 2002, Vles et al., 2003, Biederman and Faraone, 2005). Furthermore, a polymorphism of dopamine β hydroxylase, the enzyme predominantly responsible for converting dopamine to noradrenaline, has also been associated with ADHD (Biederman and Faraone, 2005). Variants in the noradrenaline transporter gene (SLC6A2) have been investigated by several studies and an A/T transversion of the rs28386840 SNP in the promoter region of SLC6A2 has been associated with ADHD and was found to decrease promoter function (Kim et al., 2006, Kim et al., 2010). Furthermore, it was shown that the same SNP is associated with response to methylphenidate as an ADHD treatment, with those individuals possessing the T/T genotype exhibiting a better response to treatment than the A/A genotype (Kim et al., 2010). The G1287A polymorphism (rs5569) of SLC6A2, has also been associated with methylphenidate response in the treatment of ADHD (Yang et al., 2004, Kim et al., 2010). Serotonin has been implicated in the regulation of impulsive, aggressive and violent behaviour (Retz et al., 2003, Nedic et al., 2010), and impaired maternal serotonin production has been associated with increased risk of the offspring developing ADHD (Halmoy et al., 2010). A functional variant of the serotonin transporter gene (SLC6A4) and a non functional marker of the serotonin 1B receptor gene have been associated with ADHD (Biederman and Faraone, 2005). A positive association has also been found between ADHD and the synaptosomal-associated protein of 25 kDa (SNAP25) (Biederman and Faraone, 2005). This neuron-specific protein plays a role in synaptic-vesicle transport and release and SNAP25 knockout mutant mice display hyperactivity (Wilson, 2000, Biederman and Faraone, 2005), hence implicating the protein in the modulation of this behaviour.

ADHD is also believed to be a neurodevelopmental disorder and this is supported by the evidence for many risk factors for the disorder being associated with critical times of brain development. Foetal exposure to a number of environmental risk factors has been implicated in ADHD, including lead exposure, poor maternal health, maternal age, long duration of labour, prematurity, foetal distress, antepartum

haemorrhage, and foetal exposure to nicotine and alcohol (Mick et al., 2002, Saigal et al., 2003, Hack et al., 2004, Indredavik et al., 2004, Biederman and Faraone, 2005, Banerjee et al., 2007). The basal ganglia is implicated in ADHD and is particularly sensitive to toxemia, and this has been shown to impact upon dopaminergic functioning, thus implicating this mechanism in ADHD (Boksa and El-Khodori, 2003, Biederman and Faraone, 2005, Banerjee et al., 2007). Behavioural, cognitive and learning problems have been associated with foetal exposure to alcohol (Boyd et al., 1991, Brown et al., 1991, Autti-Ramo, 2000, Biederman and Faraone, 2005). This is supported by evidence of foetal alcohol syndrome, which is caused by maternal alcohol consumption and displays some ADHD-like symptoms (Banerjee et al., 2007). Exposure to prenatal alcohol has been shown to be associated with hyperactive, disruptive, delinquent and impulsive behaviours in children, and an increased risk of developing psychiatric and psychosocial problems (Huizink and Mulder, 2006, Banerjee et al., 2007). Additionally, cognitive ability is impaired in children exposed to prenatal alcohol, this includes deficiencies in a number of characteristics including attention, learning and memory and social skills (Huizink and Mulder, 2006, Banerjee et al., 2007). Furthermore, functional magnetic resonance imaging (fMRI) has revealed that adults who were prenatally exposed to alcohol found it more difficult to perform a working memory task, and required increased involvement of the dorsolateral prefrontal cortex (Connor and Jarosz, 2001, Banerjee et al., 2007). Foetal exposure to nicotine has been shown to damage the brain during neurodevelopment (Biederman and Faraone, 2005). In mice foetal exposure to nicotine is associated with an increase in hyperactive behaviours and cognitive impairment (Fung and Lau, 1989, Richardson and Day, 1994, van de Kamp and Collins, 1994, Biederman and Faraone, 2005). Not only can some of the ingredients of tobacco directly affect the foetal brain, in particular carbon monoxide and tar (Ernst et al., 2001, Banerjee et al., 2007), but cigarette smoke reduces uterine blood flow, and this leads to episodic foetal hypoxia-ischaemia and malnutrition (Suzuki et al., 1980, Banerjee et al., 2007). It is hypothesised that this could cause the intrauterine growth retardation frequently observed in children of mothers who smoke (Huizink and Mulder, 2006, Banerjee et al., 2007). Nicotine also reportedly causes abnormal cell proliferation and differentiation in the foetal brain of mice and rats (Slotkin and Bartolome, 1986, Banerjee et al., 2007). Nicotine stimulates the nicotinic acetylcholine receptors (Banerjee et al., 2007), which influence

dopaminergic activity, and prenatal exposure has been shown to alter the dopaminergic and noradrenergic systems (Seidler et al., 1992, Slotkin, 1998, Biederman and Faraone, 2005, Banerjee et al., 2007).

A number of psychosocial factors have also been implicated in the risk of developing ADHD, including marital conflict, family dysfunction parental psychological problems and low social class (Palfrey et al., 1985, Biederman et al., 1995, Biederman et al., 2002, Biederman and Faraone, 2005). However it is thought to be the interaction of genetic predisposition and external environmental influence that is responsible for the development and phenotypic variability of ADHD (Banerjee et al., 2007). Recent studies have aimed to elucidate the interplay of these two sets of factors by examining the association between environmental risk factors and genetic variability. It has been demonstrated that in individuals that possessed the DAT1 440 allele and were prenatally exposed to nicotine the risk of developing ADHD was 2.9 times greater than in unexposed individuals who did not possess the risk allele (Banerjee et al., 2007, Neuman et al., 2007). Furthermore an association has been described between an increase in hyperactive and impulsive behaviours in individuals who possessed the DAT1 480 allelic variant and had foetal exposure to nicotine (Kahn et al., 2003, Banerjee et al., 2007). Variants in this gene and prenatal exposure to alcohol have also been investigated, with the findings suggesting that the risk of developing ADHD was higher when possessing a haplotype of the gene if the foetus had been prenatally exposed to alcohol (Brookes et al., 2006, Banerjee et al., 2007).

There is a high risk of comorbidity of childhood ADHD with other psychiatric and substance abuse disorders (Bird et al., 1993, Willcutt et al., 1999, Kadesjo and Gillberg, 2001, Lahey et al., 2002, Murphy et al., 2002, Biederman and Faraone, 2005), and adult ADHD with personality disorders (Modestin et al., 2001, Biederman and Faraone, 2005). Ludolph et al., 2008b, found that a considerable proportion of a population suffering from tourette syndrome also fulfilled the criteria for childhood ADHD, and the two disorders show comorbidity as characterised by the three main symptoms: impaired attention, hyperactivity and increased impulsivity which are shared by both disorders (Erenberg, 2005). The two disorders have also been found to be genetically linked (Comings, 2001) and it is speculated that the cause of both

ADHD and tourette syndrome may involve a dysfunction in the neurotransmitter systems involving the frontal cortex, the thalamus and basal ganglia (Ludolph et al., 2008b). In individuals diagnosed with comorbid ADHD and tics syndrome a reduction in the overall amygdalar volume has also been observed, and it was speculated that this may cause altered amygdala function thus contributing to the symptomology of ADHD (Ludolph et al., 2008b). There is considerable overlap in the symptomology of ADHD and autism, in particular difficulties in social interaction and communication (Luteijn et al., 2000, Hattori et al., 2006, Mulligan et al., 2009). It has been hypothesised that the similarity in the manifestation of the two disorders could be due to common aetiology or alternatively, autism could represent a subtype of ADHD (Mulligan et al., 2009). Comorbidity of ADHD with learning disability, conduct disorder and anxiety disorder has also been reported (McKay and Halperin, 2001, Rowland et al., 2002, Thome and Jacobs, 2004). There is an increased rate of conduct disorder (30-50%) in childhood ADHD patients in comparison to the control population (2-6%) (Kuhne et al., 1997, Disney et al., 1999, Matza et al., 2005, Jones and Foster, 2009), and in individuals suffering from comorbid ADHD and conduct disorder the risk of substance abuse and criminality problems is also increased (Babinski et al., 1999, Barkley et al., 2003, Jones and Foster, 2009).

The frontline pharmacological treatments for ADHD for many years have been the stimulants methylphenidate and amphetamine (Biederman and Faraone, 2005). Both amphetamine and methylphenidate exert their therapeutic action by raising dopamine levels in the striatum, nucleus accumbens, and both dopamine and noradrenaline in the prefrontal cortex (Shoblock et al., 2003b, Shoblock et al., 2004, Madras et al., 2005). However amphetamine differs from the action of methylphenidate as its mechanism of increasing extracellular dopamine is to both inhibit dopamine re-uptake by DAT, through direct competition with dopamine, and to stimulate dopamine release into the cytoplasm (Madras et al., 2005). Methylphenidate on the other hand, predominantly acts via inhibition of DAT activity and to a lesser degree NET activity, to increase levels of extracellular dopamine (Madras et al., 2005, Kim et al., 2010). However, there has been concern over possible side effects of the stimulants, including tics, stunting of growth and substance abuse (Biederman and Faraone, 2005). Conversely studies have shown that stimulant treatment for ADHD

reduces the risk of developing substance-use disorder, rather than causing the development of it (Faraone and Wilens, 2003, Wilens et al., 2003a, Biederman and Faraone, 2005). More recently, new ADHD treatments have been developed including slow-release methylphenidate and the anti-depressant non-stimulant atomoxetine (Biederman and Faraone, 2005). The benefits of slow-release methylphenidate is that it reduces the number of re-administrations of treatment per day, to fit in with the individuals daily schedule, thus reducing the embarrassment surrounding use of the medication in public and minimising the risk of missing a dose (Biederman and Faraone, 2005). The mechanism of action of atomoxetine is believed to be through selective inhibition of the noradrenaline transporter (NET) (with minimal affinity for the dopamine transporter (DAT), thus preventing noradrenaline re-uptake and causing its accumulation in the synapse (Kim et al., 2010). DAT density is low, and NET density is high in the prefrontal cortex (Kim et al., 2010). Regardless of the differing selectivity and affinities, methylphenidate, amphetamine and atomoxetine all raise dopamine and noradrenaline levels in the prefrontal cortex, however these effects are distinct between the drugs in the striatum and nucleus accumbens (Bymaster et al., 2002, Shoblock et al., 2003b, Shoblock et al., 2003a, Shoblock et al., 2004, Madras et al., 2005).

Other pharmacological medications that have been used to treat ADHD but with lesser efficacy and various unwanted side-effects include the tricyclic antidepressants, bupropion, modanafil and the α 2-adrenergic agonists clonidine and guanfacine (Biederman and Faraone, 2005). Bupropion is effective in reducing cigarette smoking, which is associated with ADHD, and it is thought it could be efficacious in treating diagnoses of ADHD comorbid with depression, bipolar disorder or substance abuse (Riggs et al., 1998, Daviss et al., 2001, Wilens et al., 2003b, Biederman and Faraone, 2005). Modinifil is used as a treatment for narcolepsy, but has been shown to alleviate some of the symptoms of childhood and adult ADHD (Taylor and Russo, 2000, Rugino and Copley, 2001, Turner et al., 2004, Biederman and Faraone, 2005). Commonly, psychosocial therapy is implemented in conjunction with pharmacological treatment for ADHD, for example behavioural modification and cognitive-behaviour therapy (Biederman and Faraone, 2005). Although these therapies have proved therapeutic, pharmacological treatments show

the greatest efficacy and are recommended as the predominant treatment for the disorder (Biederman and Faraone, 2005).

1.4 Circadian rhythms and sleep in ADHD

Sleep deficits are a prominent characteristic of ADHD, with up to 54% of children with ADHD reporting problems with sleep, (Tjon Pian Gi et al., 2003) and up to 83% of adult ADHD patients (Sobanski et al., 2008). Moreover sleep problems were recognised as a key characteristic included on a number of child rating scales in the diagnosis of ADHD in an earlier version of the *DSM* and the Conners Rating Scale for parents (Goyette et al., 1978, Corkum et al., 1998, Gruber et al., 2000). Sleep problems have been widely documented through both self and parental sleep reports, and sleep and circadian parameters have been examined by actigraphic and polysomnographic studies. However, whilst sleep deficits are clearly symptomatic of ADHD and it could be argued that ADHD symptomology could reduce the ability of an individual to be settled enough to sleep effectively, it is also plausible that these sleep deficits may be contributing to the pathogenesis of the disorder.

It has been proposed that one of the mechanisms key to the development of ADHD is the impairment of cortical inhibitory control, resulting in disinhibition of motor and frontal cortices (Castellanos, 1997, Berger and Posner, 2000, Moll et al., 2000, Moll et al., 2001, Kirov et al., 2004). This hypothesis would help to explain the sleep disturbance often observed in ADHD, since the prefrontal and frontal cortices are known to be essential for sleep regulation (Gottesmann, 1999, Muzur et al., 2002, Kirov et al., 2004). A role for sleep disturbance in the pathophysiology of ADHD is supported by the fact that some of the core symptoms of ADHD, inattention, impulsiveness and restlessness, are known characteristics of sleep deprivation (Corkum et al., 1998) and sleep deprivation has been shown to cause behavioural and cognitive problems (Bonnet, 1985, Babkoff et al., 1991, Gruber et al., 2000). Furthermore, the substantial influence of sleep deprivation upon mood is demonstrated by the efficacy of total sleep deprivation in treating depression (McClung, 2007), an association of mood problems with ADHD have been reported (McGough et al, 2005). Sleep disorders have also been associated with both childhood and adult ADHD (Cohen-Zion and Ancoli-Israel, 2004, Kirov et al., 2007,

Van Veen et al., 2010) in particular Idiopathic Sleep Onset Disorder has been shown to be comorbid with ADHD (Van der Heijden et al., 2005, Neves and Reimao, 2007, Van Veen et al., 2010). ADHD has also been associated with periodic limb movement disorder (Picchiatti et al., 1999, Boonstra et al., 2007) and sleep disordered breathing (Chervin et al., 1997, Boonstra et al., 2007). Furthermore the inattentive and hyperactive symptoms of ADHD have been associated with children who suffer from obstructive sleep apnoea (Chervin, 2005, Lim et al., 2008) and habitual snoring (Ali et al., 1993, Chervin et al., 2002a, Lim et al., 2008). Although, the inattentive and hyperactive symptoms can present themselves in patients suffering from these sleep disorders alone, without showing comorbidity for ADHD (Lim et al., 2008).

Parental and self reports of sleep in childhood ADHD have indicated a number of sleep deficits including reduced sleep duration (Lim et al., 2008) an increase in the degree of snoring (O'Brien et al., 2003a) and increased likelihood of suffering from nightmares (Chiang et al., 2010). Gender differences in sleep reports has been indicated, with female ADHD patients reporting more difficulties sleeping, however the authors speculate that this finding could be due to parental expectations of girls finding it easier to sleep than boys (Lim et al., 2008). Sub-type differences in childhood ADHD of sleep disturbance has been assessed via self-report questionnaires (Chiang et al., 2010). The combined and hyperactive-impulsive subtypes were reported to exhibit increased sleep duration in comparison to the inattentive subtype and healthy controls, whereas daytime sleepiness and napping, early insomnia, middle insomnia, sleep terrors and snoring was increased in the combined and inattentive subtypes in comparison to the hyperactive-impulsive subtype (Chiang et al., 2010). Furthermore, circadian rhythm disturbance, sleep-talking, nightmares and nightmare disorders, and circadian rhythm sleep disorders were more predominant in the combined subtype than the inattentive subtype of childhood ADHD (Chiang et al., 2010).

Actigraphy and polysomnography have been utilised as methods of measuring the sleep/wake cycle and sleep and activity parameters (Littner et al., 2003a, Littner et al., 2003b). Actigraphs store data on levels of activity via measurement of movement, whereas polysomnography can also collect data on sleep quality and

other sleep-related disorders. Actigraphic analysis has shown daytime activity of children with ADHD in a clinical setting to be greater than that of individuals who do not have the disorder, however no subtype differences in activity levels have been detected (Dane et al., 2000). In conjunction with sleep diaries, actigraphy has demonstrated increased variance in a number of sleep measures in childhood ADHD, including sleep onset time, sleep duration and true sleep time, thus indicating greater sleep instability in childhood ADHD (Gruber et al., 2000). In adult ADHD, actigraphy has revealed greater daytime activity than in the control population, although nocturnal activity as measured during the 5 hour period of least activity (L5) did not differ significantly between the two groups (Boonstra et al., 2007). Reduced sleep efficiency, longer sleep onset latency and shorter durations of uninterrupted sleep were also demonstrated in adult ADHD with or without comorbid sleep onset insomnia (Boonstra et al., 2007, Van Veen et al., 2010).

Polysomnographic studies have revealed reduced sleep efficiency, and increased awakenings and percentage wakefulness after sleep onset in adult ADHD (Sobanski et al., 2008). This is in accordance with other studies showing reduced sleep efficiency (Dagan et al., 1997, Sobanski et al., 2008) and increased nocturnal awakenings in childhood ADHD (Ramos Platon et al., 1990, Picchietti et al., 1998, O'Brien et al., 2003b, Sobanski et al., 2008). These findings are however contradicted by previous studies of adult and childhood ADHD (Busby et al., 1981, Greenhill et al., 1983, Philipsen et al., 2005, Sobanski et al., 2008). The percentage of rapid-eye movement (REM) sleep has also been shown to be reduced in adult ADHD (Sobanski et al., 2008). Therefore this could have implications for behavioural functioning, since REM sleep is associated with learning and performance, including attention, memory and language (Siegel, 2001, Sobanski et al., 2008). A reduction in % REM sleep has also been observed in childhood ADHD, along with an increase in REM sleep latency (O'Brien et al., 2003a).

Since the circadian clock is key to the regulation of the sleep-wake cycle as previously described, studies have aimed to establish if circadian deficits are evident in ADHD. A recent study has shown that adult ADHD is associated with evening preference, with more than 40% of the ADHD study population exhibiting evening preference, whereas only 18.5% exhibited morning preference, which is in stark

contrast to findings that in the general population that only 10.8% exhibit evening preference and 40.2% exhibit morning preference (Rybak et al., 2007). In addition, it was found that greater eveningness correlated with increased difficulty in sustaining attention and a higher level of impulsive behaviour (Rybak et al., 2007). It was suggested that the inattention aspect of ADHD symptomology may be due to lowered arousal levels as a consequence of a sleep deficit that the individual may be experiencing (Rybak et al., 2007), hence implicating sleep disturbance as a factor in the psychopathology of the disorder. The mechanism responsible for the formation of chronotype has been proposed to involve the interaction of sleep homeostasis and circadian rhythms in the hypothalamus (Schmidt et al., 2009). This hypothesis would explain the evening decrease in alertness of morning chronotype individuals as being due to either a greater negative influence of sleep homeostasis on the anterior hypothalamus regions involved in circadian regulation or reduced influence of the circadian clock on sleep homeostasis arising from the anterior hypothalamus (Schmidt et al., 2009). Circadian disturbance is further implicated in ADHD by findings that seasonal affective disorder is comorbid with ADHD in some cases (Levitan et al., 1999, Amons et al., 2006, Van Veen et al., 2010).

As previously described, melatonin is a key output and regulator of the circadian clock (Reppert and Weaver, 2001, Pierce et al., 2008, Wiechmann and Summers, 2008), and plays an important role in the modulation of the sleep-wake cycle (Tzischinsky et al., 1993, Zhdanova et al., 1996, Zhdanova and Tucci, 2003, Pandi-Perumal et al., 2005). A delay in dim light melatonin onset, and also sleep and wake time, as measured by actigraphy, has been associated with both childhood and adult ADHD when comorbid with sleep onset insomnia, whereas both child and adult ADHD patients, who did not suffer from the sleep disorder, displayed normal dim light melatonin onset timing (Van der Heijden et al., 2005, Van Veen et al., 2010). This delay in circadian timing of the sleep/wake cycle observed in sleep onset insomnia is characteristic of delayed sleep phase disorder (DSPS), and therefore it has been proposed that sleep onset insomnia is a circadian rhythm disorder that is comorbid with ADHD (Van der Heijden et al., 2005, Van Veen et al., 2010). Furthermore subtype differences in the prevalence of sleep onset insomnia have been indicated, with a decreased number of the inattentive ADHD subtype of adults displaying symptoms of sleep onset insomnia in comparison to the other subtypes

(Van Veen et al., 2010). As expected the inattentive subtype patients that did not suffer from sleep onset insomnia exhibited longer sleep duration and more stable sleep/wake rhythms in comparison to those individuals diagnosed with the sleep disorder, and this is in accordance with previous reports that inattentive subtypes of ADHD are sleepier during the day and sleep for longer durations at a time (Gau et al., 2007, Mayes et al., 2009, Van Veen et al., 2010), and it could be postulated that disturbance in the melatonin rhythm could exacerbate behavioural and cognitive problems via the effects this has upon the sleep/wake cycle. Furthermore, the potential for abnormalities in the melatonin rhythm to have downstream effects upon the peripheral oscillators and other behavioural and physiological processes that contribute to the pathophysiology of the disorder, is demonstrated in rodents where a constantly high level of melatonin in rats causes a reduction in the amplitude of the circadian rhythms of temperature and heart-rate (Simon et al., 2002).

It has been proposed that dysfunction of the behavioural inhibition system could be responsible for some of the altered behaviours characteristic of ADHD (Quay, 1997, Lackschewitz et al., 2008). The HPA-axis is involved in stress response and regulation (Hastings et al., 2009) and levels of the adrenal hormone cortisol are widely used as an indicator of HPA-axis reactivity, as HPA-axis activation in response to stress initiates the release of the adrenal hormone cortisol (Chrousos and Gold, 1992, Randazzo et al., 2008). Therefore it has been postulated that if a dysfunctional behaviour inhibition system is a causative factor of ADHD then an abnormal HPA axis response to stress should be observed in ADHD (Hong et al., 2003).

Lowered circulating cortisol levels in response to stress has been associated with many of the characteristics of childhood ADHD including maladaptive behaviour (Hastings et al., 2009) and poorer cognitive performance (Hanna et al., 1996, Hong et al., 2003), as well as being associated with a decreased degree of anxiousness in childhood ADHD (Hastings et al., 2009). These findings have been replicated in a study of adult ADHD, which found that lower cortisol levels in response to stress were associated with ADHD (Lackschewitz et al., 2008). Due to the considerable differences in symptomology, ADHD is a disorder that can be divided into three subtypes (McGough and Barkley, 2004, Biederman and Faraone, 2005), and

therefore ADHD subtype differences in the stress response have also been investigated, but with contradictory results. Under-reactivity of the HPA-axis in response to stress has been associated with the hyperactive/impulsive subtype of ADHD (Virkkunen, 1985, Moss et al., 1995, Hong et al., 2003, Blomqvist et al., 2007). However, the inattentive ADHD subtype has also been shown to display blunted cortisol levels and hence impaired HPA-axis functioning in response to stress (Randazzo et al., 2008). Other studies have shown that low-cortisol responsivity to psychosocial stress is associated with childhood ADHD-combined, but not for those with ADHD-inattentive (van West et al., 2009). Possible reasons for this discrepancy could be effects of treatment, comorbidity and study design, since measurement of stress response in a laboratory setting could itself alter stress levels. Furthermore, gender differences in the stress response have been identified in childhood ADHD, with elevated early morning cortisol levels in boys, and decreased levels in girls (Sondeijker et al., 2007). It was postulated that this could be due to the gender differences in symptomology, with lower levels of hyperactivity and other externalizing behaviours being associated with female ADHD patients (Gaub and Carlson, 1997, Gershon, 2002, Sondeijker et al., 2007).

Studies of the circadian rhythm of cortisol secretion in ADHD are somewhat contradictory with a normal rhythm being demonstrated in adult ADHD (Hirvikoski et al., 2009). Furthermore no difference in the diurnal profile of cortisol was detected between two ADHD groups of high-post stress cortisol and low-post stress cortisol (Hirvikoski et al., 2009). An association of high-post stress cortisol concentrations were found with impulsivity, depression and anxiety (Hirvikoski et al., 2009), but since no alteration in diurnal cortisol profiles were detected, it can be assumed that these symptoms are related to the role cortisol plays in the HPA-axis response to stress rather than the circadian clock. The finding of a normal diurnal rhythm of cortisol in ADHD is in agreement with a previous studies carried out in a laboratory setting, of both adult ADHD (Lackschewitz et al., 2008), and childhood ADHD (White and Mulligan, 2005). However, abnormal cortisol rhythms have been associated with the hyperactive component of childhood ADHD (Kaneko et al., 1993) and dampened cortisol awakening response (Blomqvist et al., 2007), although a later study has demonstrated no childhood ADHD subtype differences in the cortisol rhythm (Hastings et al., 2009). The cortisol awakening response has also

been studied in children suffering from ADHD with comorbid disruptive behaviour disorder, and it has been shown that whilst childhood ADHD patients exhibit a normal cortisol awakening response (Snoek et al., 2004, Freitag et al., 2009), those ADHD patients with comorbid oppositional defiant disorder exhibited a dampened cortisol awakening response, hence indicating dysfunction in the HPA-axis in association with the symptoms of disruptive behaviour disorder (Freitag et al., 2009).

The association of the T-allele of the rs1801260 SNP in *CLOCK* with adult ADHD provides further evidence for a putative role of the circadian clock in the pathogenesis of the disorder (Kissling et al., 2008, Xu et al., 2010). In healthy populations the C allele of the polymorphism has also been shown to be associated with evening preference and delayed sleep timing (Katzenberg et al., 1998, Mishima et al., 2005). Therefore the association of the rs1801260 C/T SNP with chronotype and sleep disturbance in psychiatric illness further implicates this polymorphism in sleep regulation. Since this SNP is located in the 3' flanking region of *CLOCK* it can be postulated that the presence of either the T or C allele may exert effects upon polyadenylation or mRNA stability (Beelman and Parker, 1995, Ross, 1996, Benedetti et al., 2003, McClung, 2007) with possible effects upon the level of protein being translated (Benedetti et al., 2003).

The treatment of sleep-related disorders have been shown to improve daytime function in children with ADHD (Van der Heijden et al., 2007), and several therapies that interact with the circadian clock have been trialled for the treatment of ADHD. A three week trial of daily morning bright light therapy for adult ADHD has been shown to cause a shift towards an earlier chronotype and to improve the core symptoms of the disorder, and this improvement appeared to be independent of any therapeutic effect on depressive symptoms (Rybak et al., 2006, Terman, 2007). Melatonin treatment in childhood ADHD patients suffering from insomnia has been shown to improve a number of sleep measures including an increase in the mean total time asleep and sleep efficiency, and a decrease in sleep latency, nocturnal restlessness and difficulty falling asleep (Van der Heijden et al., 2007). Furthermore sleep onset and dim light melatonin onset was advanced to that of values found in healthy children not suffering from insomnia, and this effect was more pronounced in individuals who exhibited more extreme delays in dim light melatonin onset at

baseline (Van der Heijden et al., 2007). However, whilst these sleep deficits were improved, no improvement of behaviour, cognitive function or quality of life was observed in these individuals, and it was suggested that the sleep improvements were not great enough to impact upon the core ADHD symptoms, for which longer treatment duration would be required (Van der Heijden et al., 2007).

The spontaneous hypertensive rat (SHR) is a well documented rodent model for ADHD since it displays all the behavioural symptoms of the disorder when compared to the normotensive Wistar-Kyoto (WKY) control rat (Russell, 2007). A number of anomalies in the dopaminergic and noradrenergic systems have been observed in SHR, including reduced DAT expression in the prenatal SHR midbrain and elevated DAT expression in the adult SHR (Watanabe et al., 1997, Leo et al., 2003, Russell, 2007). A disturbance in dopaminergic and noradrenergic neurotransmission in the prefrontal cortex of SHR has been documented, with a reduction in dopamine release, and an increase in noradrenaline, not only in the prefrontal cortex but the locus coeruleus and substantia nigra also (de Villiers et al., 1995, Russell, 2002, Russell, 2007). These findings are consistent with reports of hypofunctional dopamine systems and hyperfunctional noradrenaline systems in the prefrontal cortex in childhood ADHD (Solanto, 1998, Russell, 2002, Russell, 2007). The expression of VIP mRNA has been shown to be elevated in the SHR brain in comparison to WKY, and therefore an impact upon the circadian system could be postulated, since VIP has been implicated in entrainment to the LD cycle (Peters et al., 1994). Moreover, significant alterations in the circadian rhythm of locomotor activity of SHR in comparison to WKY have been demonstrated, with a phase advance in wheel running behaviour under LD, and under constant light and constant darkness conditions the free-running locomotor rhythm was significantly shorter for SHR than for the WKY controls (Peters et al., 1994). Additionally, SHR differ in their responses to phase advances and delays of the LD cycle in comparison to the control, with SHR taking significantly longer to entrain to a phase delay, whilst being significantly quicker to entrain to a phase advance than the WKY control rats (Peters et al., 1994). SHR has also been found to differ to WKY in its light sensitivity (Rosenwasser, 1993), and sleep alterations in the SHR model in comparison to the WKY control model have been observed, including more frequent interruptions to sleep being associated with SHR (Kuo et al., 2004).

1.5 The effects of ADHD medication upon sleep and the circadian clock

There are mixed reports of the effects of methylphenidate upon sleep in ADHD, with actigraphy and polysomnography studies revealing improvements including a reduced number of actigraphically assessed nocturnal awakenings and a significant reduction in sleep onset latency and improved sleep efficiency in patients undergoing methylphenidate treatment (Boonstra et al., 2007, Sobanski et al., 2008). However in contrast, there have been reports of increased sleep onset latency in adult ADHD patients undergoing methylphenidate treatment (Boonstra et al., 2007), and insomnia has been documented in both methylphenidate medicated childhood and adult ADHD patients (Sangal et al., 2006). Improvement in some sleep parameters by atomoxetine treatment has also been documented in ADHD, including a reduction in both the onset of sleep and difficulty to settle down, and an improvement in ease of getting up in the morning (Sangal et al., 2006). Comparisons of the effects upon sleep by atomoxetine and methylphenidate have indicated that atomoxetine generally appears to produce less adverse side effects upon sleep than methylphenidate and it has been postulated that the high specificity of atomoxetine for the noradrenaline transporter, with little affinity for other monoaminergic transporters or receptors could be responsible for the reduced negative impact upon the sleep/wake cycle than the psychostimulants (Sangal et al., 2006). Moreover the same study demonstrated an improvement in childhood ADHD symptoms in the morning and evening when undergoing atomoxetine treatment as oppose to methylphenidate (Sangal et al., 2006), and thus it could be postulated that the improvement in behaviour could be partly due to the improvement in sleep. However, it is worth noting that to the contrary it could be argued that an improvement in sleep could be a consequence of an improvement in behaviour, since presumably a reduction in hyperactive and restless behaviour for example, would improve the ability of the individual to settle down to sleep.

Investigations of the effects of the psychostimulants methamphetamine and methylphenidate upon the rodent circadian system have revealed significant alterations of the rodent locomotor rhythm by chronic administration of both treatments (Honma et al., 1986, Honma et al., 1988, Tataroglu et al., 2006, Honma et al., 2008, Algham et al., 2009, Algham et al., 2010, Lee et al., 2010). The presence

of a methamphetamine sensitive oscillator is well documented, and evidence for its existence stem from the observations that chronic methamphetamine treatment desynchronizes the locomotor rhythm of SCN intact rodents from the LD cycle and produces a significant rhythm of locomotor activity in otherwise arrhythmic SCN lesioned rodents (Honma et al., 1986, Tataroglu et al., 2006, Honma et al., 2008). Furthermore, chronic methamphetamine treatment of SCN-lesioned rodents has been shown to alter a number of physiological rhythms, including feeding, body temperature and plasma corticosterone levels (Honma et al., 1988). Moreover, chronic methamphetamine treatment has been shown to alter circadian clock gene expression in the hippocampus (Yamamoto et al., 2005), and in the striatum where this was associated with shift in the behavioural rhythm (Masubuchi et al., 2000). Chronic methylphenidate treatment has also been shown to shift the rodent locomotor rhythm (Algahim et al., 2009, Algahim et al., 2010, Lee et al., 2010), although effects upon the molecular circadian clock have not been documented to date. Although significant effects of the antidepressant, atomoxetine, upon sleep architecture and other sleep measures in ADHD have been documented (Sangal et al., 2006), as of yet the effects of atomoxetine upon rodent locomotor activity or the molecular circadian clock have not been investigated.

Collectively the research to date would suggest a role of the circadian clock in manifestation of psychiatric illness including ADHD, and furthermore a potential mechanism of pharmacological treatments to produce both therapeutic and adverse side effects by interaction with the circadian clock.

Therefore it is hypothesised firstly that deficiencies of the circadian timing system are associated with adult ADHD, which could contribute to the psychopathology of the disorder, and secondly that ADHD medications modulate the functioning of the circadian system, which contributes to the therapeutic and adverse side effects of these medications. The main aims of this work were therefore firstly to develop a non-invasive method of sampling the human circadian clock, secondly to utilise this method to assess circadian rhythms in behaviour, endocrine parameters and circadian clock gene expression in adults with ADHD in comparison to matched controls. Thirdly, to assess whether alterations in these parameters are associated with

alterations in objectively observed sleep parameters, and lastly to assess how ADHD medications affect circadian clock protein expression in the rodent brain.

**Chapter 2: The development of a non-invasive technique for the
assaying of human circadian clock function**

Chapter 2: Development of a non-invasive technique for the assaying of human circadian clock function

2.1 Introduction

Actigraphy

Actigraphy is a well validated method of assessing the rest-activity rhythm, from which information regarding a number of activity and sleep measures can be gleaned (Littner et al., 2003b). Actigraphy has previously been utilized successfully to define alterations in circadian activity patterns in a number of medical conditions including psychiatric illness and sleep disorders (Sadeh et al., 1995, Littner et al., 2003b, Wiggs and Stores, 2004, Jones et al., 2005, Boonstra et al., 2007). A measure of circadian preference is provided by chronotype which refers to the time of day of an individual's innate preference to be active and can be accurately assessed by means of the Horne-Ostberg morningness/eveningness questionnaire (Horne and Ostberg, 1977). This scale designates individual's preference as one of three categories; morning, evening or intermediate (Horne and Ostberg, 1977), with the majority of healthy individuals being of intermediate chronotype (Paine et al., 2006). However, there is a disadvantage to the use of this questionnaire, due to the time-line format of the answers that can be selected to the questions. This does not allow for precise time estimation, but rather the choice of a time-range, and therefore it is thought that this could skew the distribution of the data (Neubauer et al, 1992).

Salivary concentrations of the hormones cortisol and melatonin are widely documented to exhibit circadian rhythmicity and these hormones are key outputs of the master circadian pacemaker, influencing peripheral oscillator entrainment to the master circadian clock (Keller et al., 2006, Wiechmann and Summers, 2008). Assaying of the 24 hour profiles of salivary cortisol and melatonin levels therefore provide indication of circadian phase and indirectly of the functional status of the circadian clock on the master level. The assaying of the human molecular circadian clock poses a number of practical problems including firstly the accessibility of tissue. Since the assaying of the human SCN is only possible in post mortem tissue, the circadian system could be subject to disturbance as observed in various disease

states (eg. Wu et al., 2006, Hoffman et al., 2010, Tseng et al., 2010) and with aging (eg Ando et al. 2010, Wyse and Coogan, 2010). Secondly, alterations to an individuals sleep/wake cycle and sleep quality may be caused by unnatural schedules imposed upon subjects who partake in a circadian study within a research facility or hospital. Thirdly, it is not clearly defined how the oscillatory nature of the peripheral clocks relate to that of the SCN, and therefore the molecular clockwork of the peripheral oscillators may not be representative of that of the SCN. More recently, laboratories have been utilising the presence of molecular circadian clocks in peripheral and easily accessible human tissues as a method of assessing human circadian clock functioning, these tissues include peripheral blood mononuclear cells, fibroblasts, hair follicle cells and the oral mucosa (Bjarnason et al., 2001, Takata et al., 2002, Boivin et al., 2003, Teboul et al., 2005, Cajochen et al., 2006, Archer et al., 2008, Yang et al., 2009, Akashi et al., 2010, Pagani et al., 2010).

Assessing RNA integrity

When assaying gene expression in any tissue RNA integrity is essential for accurate quantification of gene expression by quantitative RT-PCR (Fleige and Pfaffl, 2006). The 28S:18S ribosomal RNA (rRNA) ratio provides an indicator of RNA degradation, with a ratio of 2.0 being indicative of intact, high quality RNA, and an elevated threshold baseline and decreased 28S:18S ratio both being indicative of degradation (Imbeaud et al., 2005). Other measures of RNA integrity are the RNA integrity number (RIN) and RNA quality index (RQI) numbers, which are equivalent measures of RNA degradation that are calculated by analogous automated electrophoresis systems (Godler et al., 2009). In both cases a value of 10 is predictive of intact RNA, and 1 represents total mRNA degradation (Imbeaud et al., 2005, Taylor et al., 2010).

Normalisation of gene expression

Since the central principal of gene expression quantification by quantitative RT-PCR is that the greater the number of copies of the target present in the sample, the fewer amplification cycles that will be required for the fluorescence to reach the threshold of detection, there are therefore a number of factors that it is essential are controlled

for by normalisation to ensure reliable measurement of gene expression (Bustin et al., 2005). These factors include, polymerase inhibitors, quantity of sample RNA, differing amplification efficiencies and between sample variation (Bustin et al., 2005).

However, there is currently much controversy surrounding the most appropriate method of normalisation (Bustin, 2002). The most commonly used normalisation method is the quantification of housekeeping gene expression, use of which is based upon the idea that its expression will reflect the quantity and quality of the target gene mRNA, whilst being minimally effected by experimental conditions (Godler et al., 2009). However it has been proposed that all house-keeping genes probably do vary in their levels of expression, due to various factors such as the developmental stage, cell cycle stage and experimental conditions (Bustin, 2000, Tricarico et al., 2002). Both β -actin and most commonly glyceraldehyde-3 phosphate dehydrogenase (*GAPDH*) have been widely used as housekeeping gene controls for the normalisation of gene expression (Lupberger et al., 2002, Tricarico et al., 2002), and in a study to assess the effects of experimental conditions upon housekeeping gene expression, serum stimulation was shown to increase the expression of both β -actin and *GAPDH* in human fibroblasts (Schmittgen and Zakrajsek, 2000).

Other methods of normalisation include using total mRNA or rRNA amounts as a standard (Bustin et al., 2005, Godler et al., 2009). However, disadvantages of normalising to total mRNA amounts are firstly that accurate quantification of total mRNA amounts is compromised when extracting RNA from small samples. Secondly, normalisation of gene expression to total mRNA amounts does not allow for consideration of RT-PCR inhibitors, as this measurement is not subject to this inhibitor, in contrast to the co-amplification of a housekeeping gene alongside the target gene (Bustin, 2002). Additionally transcriptional activity may differ between individuals and between different types of tissue (Bustin, 2002, Tricarico et al., 2002), with total mRNA amounts being known to be elevated in highly proliferating cells (Bustin et al., 2005). Although in tissues such as nucleated blood cells minimal variation of total mRNA between individuals has been observed (Bustin, 2002). rRNA however, is thought to vary to a lesser degree than mRNA in human tissue samples (Bustin et al., 2005) and to be more reliable than normalising against the

expression of a panel of housekeeping genes in human skin fibroblasts (Mansur et al., 1993). Although, there are a number of drawbacks of this approach including that additional PCR protocols would be required to assay the amount of rRNA (Bustin et al., 2005), there may be between sample imbalances between rRNA and mRNA amounts (Solanas et al., 2001, Bustin et al., 2005), differing kinetics in the amplification of rRNA and mRNA due to the considerable difference in their abundance and in their degradation kinetics (Godler et al., 2009) and possible effects of biological factors and drugs upon rRNA expression (Spanakis, 1993, Bustin et al., 2005).

Human oral mucosa consists of rapidly proliferating cells, since it is subject to frequent injury and it is thought to have a requirement for more rapid healing in comparison to other tissues, such as cutaneous tissue (Angelov et al., 2004, Warburton et al., 2005), in order to minimise infection caused by oral pathogens (Warburton et al., 2005). As previously mentioned total mRNA amounts may be elevated in tissues that undergo rapid cell proliferation (Bustin et al., 2005), such as the oral mucosa. Cell cycle proteins have been shown to be under circadian control in the oral mucosa (Bjarnason et al., 1999) and cell proliferation involves activation of a number of transcriptional pathways involving inflammation and healing (Warburton et al., 2005) various aspects of which have been shown to be under some circadian modulation in various human and rodent tissues (Lavker et al., 1991, Irwin et al., 2006, Wang et al., 2006). Both β -actin and *GAPDH* have previously been utilised as housekeeping genes in the normalisation of clock gene expression in the human oral mucosa (Bjarnason et al., 2001, Cajochen et al., 2006) with *GAPDH* expression having been shown to be constitutively expressed in this tissue under both wound and repair conditions (Warburton et al., 2005, Cajochen et al., 2006).

Aims

The main aims of this work were therefore to firstly develop a non-invasive technique of sampling RNA in the oral mucosa for subsequent clock gene analysis and secondly to ascertain the most appropriate method of normalisation of clock gene expression in this tissue by comparing normalisation to total mRNA and to *GAPDH* expression.

2.2 Method

Subjects

Adult healthy subjects (n=19) were recruited from the university staff, hospital staff and a student population. Average age of the participants was 27.83 ± 9.43 years, and consisted of 30% male and 70% female participants. Only subjects that were not showing evidence of suffering from a current psychiatric or sleep disorder were included in the study. Each participant was assessed using a semi-structured clinical interview supplemented by the Research Version of the Structured Clinical Interview for DSM-IV-TR- Axis I Disorders (SCID-RV), in addition to ADHD questionnaires and psychometric tests; (WHO's Adult ADHD Self Report Scale (ASRS), Conners scales (CAARS-Self-Report Long Version and CAARS-Observer Long Version) and the Wender-Utah Rating Scale (WURS) for retrospective information on childhood ADHD. Chronotype was assessed by completion of the Horne-Ostberg questionnaire.

Actigraphy

Subjects wore an ActiWatch Light (Cambridge Neurotech, UK) on their non-dominant wrist for at least 7 days, the last day of which was when mucosal/salivary samples were collected. Data was transferred for analysis from the ActiWatch to a PC, upon which the Sleep analysis software (Cambridge Neurotech, UK) was installed. Data analysis excluded the first and last days of data collection. Wake times were calculated from actigraphic data by means of the "auto" detection of minimal activity threshold above which an epoch is defined as being during waking time (Sleep analysis software, Cambridge Neurotech). Analysis of actigraphic data was via non parametric circadian rhythm analysis (Van Someren et al, 1999) as well as by 24 hour co-sinor analysis. These methods yielded a number of measures:

Intradaily variability: This is an index of fragmentation of the rhythm, and assesses frequency of transitions between periods of activity and inactivity.

Interdaily stability: This is a measure of the stability of the rhythm between days, and is taken as a measure of the strength of entrainment of the endogenous circadian clock to environmental Zeitgebers.

L5: This is the amount of activity counts that occurs in the least active 5 hours of the 24 hour cycle.

L5o: This is the time of onset of the least active five hour period.

M10: This is the amount of activity in the most active 10 hour period.

M10o: This is the time of onset of the most active 10 hour period.

Relative amplitude: Indicates quantity of activity, derived from the normalized difference between M10 and L5 hour period in an average 24 hour pattern. Values range between 0 and 1, 1 representing the greatest difference between the most and least active phases, and thus the best temporal organisation of the activity cycle.

Amplitude: This is the peak-to-trough difference in terms of activity counts.

Period: This is the period that shows best fit to the data by means of a chi-squared periodogram.

Acrophase: This is the time of the peak of the best fit periodogram.

The ActiWatch also recorded a number of light measures including daily average illumination (lux), maximum illumination (lux) and time spent above the baseline level of light (100 lux). Sleep measures recorded included sleep efficiency, sleep-onset latency, sleep start and end, and total length of sleep.

Clock gene analysis

Buccal samples were collected every four hours over a 24 hours period using foam tipped swabs (Whatman International Ltd, UK) and the material was stored on FTA cards (Whatman International Ltd, UK) at room temperature. RNA was extracted from the FTA cards using the Magmax viral RNA isolation kit (Ambion, UK) and concentrated using carrier RNA and the micro-magnetic beads provided within the kit. RNA concentrations were measured in duplicate using the NanoDrop 8000 spectrophotometer (Thermo Scientific, USA), with purity assessed by the A260/A280 ratio and adequate values rated as between 1.8 and 2 (Taylor et al., 2010). The quality and quantity of total mRNA isolated was confirmed using the experion RNA HighSens analysis kit (Bio-Rad, UK) and the experion automated electrophoresis system (Bio-Rad, UK). RNA integrity was assessed by measurement of both the 28S:18S ribosomal RNA ratio with the highest value of 2 indicating intact RNA, and the RNA quality indicator (RQI), which gives a rating of 1 to 10,

with 1 being degraded RNA, and 10 being intact RNA (Taylor et al., 2010). There was no evidence of variations of mRNA quality according to time of sampling.

One-step quantitative real-time PCR was performed using the Light Cycler 3.5 (Roche Diagnostics, Germany) with SYBR-Green I dye amplimer detection.

For amplification of the target RNA the following primers were used:

PER2 forward: 5'-GCATCCATATTTCACTGTAAAAGA-3',

PER2 reverse: 5'-AGTAAAAGAATCTGCTCCACTG-3', (Cajochen et al., 2006),

BMAL1 forward: 5'-AAGGATGGCTGTTCAGCACATGA-3',

BMAL1 reverse: 5'-CAAAAATCCATCTGCTGCCCTG-3' (Bjarnason et al., 2001),

PER1 forward: 5'-CTGAGGAGGCCGAGAGGAAAGAA-3'

PER1 reverse: 5'-AGGAGGAGGAGGCACATTTACGC-3' (Bjarnason et al., 2001),

GAPDH forward: 5'-GAAGGTGAAGGTCCGAGT-3',

GAPDH reverse: 5'-GAAGATGGTGATGGGATTTTC-3'.

RNA was added to a reaction mixture of final volume 20µl containing one-step RT-PCR kit components (RNA Master SYBR Green I, Roche Diagnostics, UK) with appropriate primers at 0.5µM and 2.5mM MnOAc₂. The following PCR conditions were used. *PER2* and *PER1*: 20 min at 61°C, 30 s at 95°C, followed by 50 cycles of 1 s at 95°C, 5 s at 55°C, 13 s at 72°C and 1 s at 75°C. *BMAL1*: 20 min at 61°C, 30 s at 95°C, followed by 50 cycles of 1 s at 95°C, 5 s at 60°C, 13 s at 72°C and 1 s at 78°C, *GAPDH*: 20 min at 61°C, 30 s at 95°C, followed by 50 cycles of 1 s at 95°C, 5 s at 57°C, 13 s at 72°C and 1 s at 78°C. All samples were amplified in duplicate, and all PCR reactions included duplicate water blank samples as a negative control. Melting curve analysis followed each of these protocols.

To ascertain the most appropriate normalisation method, clock gene expression levels were normalised both to relative mRNA abundance and to the levels of the *GAPDH* gene using the $2^{-\Delta\Delta CT}$ method (eg. Cajochen et al, 2006).

Melatonin and cortisol analysis.

Saliva samples were collected every four hours over a 24 hours period (at the same time periods as buccal sampling), by chewing on a cotton swab (Salivettes, Bühlmann Laboratories, Schönenbuch Switzerland) and subsequently stored at -20°C prior to analysis. Subjects were asked to collect night time samples under dim illumination. Prior to analysis saliva samples were thawed at room temperature and centrifuged at 2000-3000 x g for 10 minutes to remove particulate material. Both the levels of cortisol and melatonin of the spun saliva samples were assayed in duplicate by ELISA, according to the manufacturer's protocol (IBL international, Germany). The optical density of each well was determined using a microplate spectrophotometer at 450 nm (reference wavelength 600-650 nm). A standard curve of the optical densities against their corresponding concentrations of the standards supplied within the kit was calculated using a 4 parameter logistics fit, and the concentrations of the samples were subsequently calculated from the standard curve.

Statistical Analysis

The statistical software SPSS (IBM Corporation, USA) installed on a PC was used to carry out analysis of correlations between actigraphic measures and chronometric parameters using Pearson's product moment correlation, two-tailed. Clock gene expression and hormone data was fitted by the method of single co-sinor analysis to determine whether significant circadian rhythms were present, by means of the Chronolab software (Mojon et al., 1992). This involved fitting a curve with a 24 period to the observed data by the least squares method, with the fit deemed significant if the 95% confidence interval for the fitted amplitude did not include zero. $f(t_i) = M + A \cos(\omega t_i + \phi) + \varepsilon_i$ was the formula for curve fitting, where $f(t_i)$ was the expression of the factor of interest across time for individual i , M was the MESOR, the time series mean around which expression oscillates, A was the amplitude of the rhythms, ω was the period of the fitted rhythm and was the acrophase of the rhythm and ε_i the error term. The regression fitting also produced an r-squared statistic,

which was then used to compute the percentage of variance in an individuals time-series data that is accounted for by the fitted 24hour curve.

2.3 Results

2.3.1 Actigraphy and Chronotype

Each subject wore an actiwatch to record various activity and sleep parameters and levels of light intensity. The 5 hours of least activity commenced in the very early of the morning (figure 2.1), with the amount of activity exhibited in these 5 hours (L5) being 1250.81 ± 726.42 , and an actigraphically calculated time of onset (L5o) of 1.76 ± 1.14 hours (table 2.1, figures 2.1 and 2.2). The amplitude of the rest-activity rhythm was 20012.90 ± 4740.50 and the activity during the 10 hours of most activity (M10) was calculated as 21263.67 ± 4740.40 , with a time of onset (M10o) during mid morning, 10.43 ± 1.69 hours (figure 2.1) and an acrophase of 15.43 ± 1.36 hrs (table 2.1, figures. 2.1 and 2.2). The average activity rhythm exhibited a period length of 23.88 ± 0.33 hrs, with period deviation calculated as 0.17 ± 0.18 hours (table 2.1, figure 2.3). Interdaily stability (IS) and intradaily variability (IV) were calculated as 0.54 ± 0.15 and 0.77 ± 0.21 respectively, and the relative amplitude of the rest-activity rhythm was 0.89 ± 0.05 . The average bed time was $23:45 \pm 00:55$, with an average time of sleep start at $00:19 \pm 01:00$ hrs (table 2.2). The average time of sleep end was $07:59 \pm 00:47$ hrs, and get up time was $08:20 \pm 00:45$ with the wake time calculated as 8.09 ± 1.59 hrs (tables 2.1 and 2.2). The actual duration of sleep ($07:01 \pm 00:40$ hrs, table 2.2) was just under an hour shorter than the assumed duration of sleep ($07:57 \pm 00:46$ hrs, table 2.2) and the actual duration of time spent awake was $00:59 \pm 00:13$ hrs (table 2.2) with the proportion of time spent in bed asleep and awake $87.15 \pm 2.46\%$ and $12.85 \pm 2.46\%$ respectively (table 2.2). The number of wake bouts during the period of sleep was 41.15 ± 9.25 , and the average duration of wake bouts and sleep bouts were $01:30 \pm 0.61$ mins and 15.75 ± 22.08 mins respectively (table 2.2). Average sleep efficiency was $79.09 \pm 4.88\%$, and the latency to sleep onset was on average 0.44 ± 0.37 hrs (table 2.2). According to the Horne-Ostberg morningness/eveningness questionnaire the average score of the participants was 53.84 ± 11.09 (table 2.1), which is assigned as intermediate chronotype (morning chronotype = 59-86, intermediate chronotype = 42-58 and evening chronotype <42). Both average and maximum light illumination were greatly reduced during the hours of midnight to 6am (2.29 ± 4.27 lux and 706.23 ± 1804.96 lux respectively), in

comparison to the full 24 hour period (366.42 ± 458.22 lux and 14800.21 ± 7977.85 lux respectively) (table 2.3).

IS	0.54 ± 0.15
IV	0.77 ± 0.21
M10	21263.67 ± 4740.50
M10o (h)	10.43 ± 1.69
L5	1250.81 ± 726.42
L5o (h)	1.76 ± 1.14
Amplitude	20012.90 ± 4799.96
Relative amplitude	0.89 ± 0.05
Period (h)	23.88 ± 0.33
Period deviation (h)	0.17 ± 0.18
Acrophase (h)	15.43 ± 1.36
Wake time (h)	8.09 ± 1.59
HO MEQ Score	53.84 ± 11.09

Table 2.1. Chronometrics of the actigraphic circadian rhythm and the Horne-Ostberg morningness/eveningness (HO MEQ) score (means and standard deviations). IS = Interdaily stability; IV = intradaily variability; M10 = activity counts in the 10 most active hours; M10o = time of onset of the ten most active hours; L5 = activity counts in the five least active hours; L5o = time of onset of the least active five hours; Amplitude = peak amount of activity; Relative amplitude = difference between L5 and M10; Period = duration of 1 full cycle of the rest-activity rhythm; Period deviation = difference in period length from 24 hours; Acrophase = peak phase of rhythm; Wake time = actigraphically determined wake time.

Subject 1

Subject 2

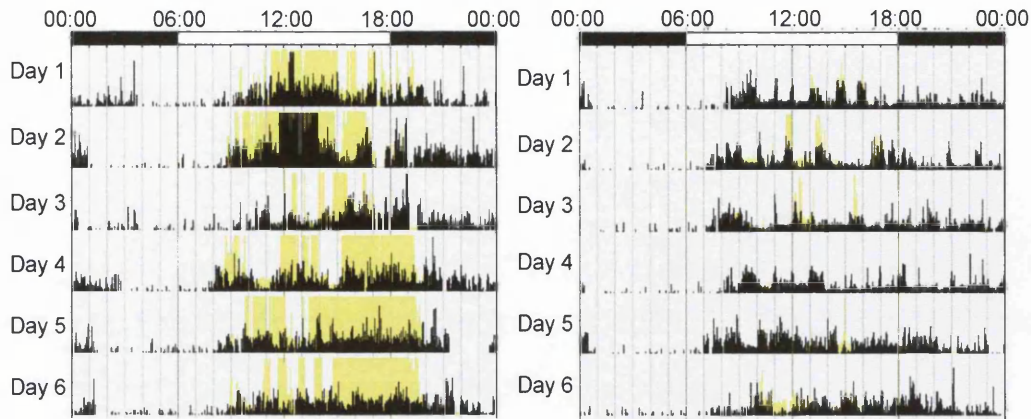

Figure 2.1. Example actograms of the daily activity levels measured by the actiwatch. Both subjects exhibit decreased activity during the hours of 12am-6am. (Activity = black, light illumination = yellow).

Subject 1

Subject 2

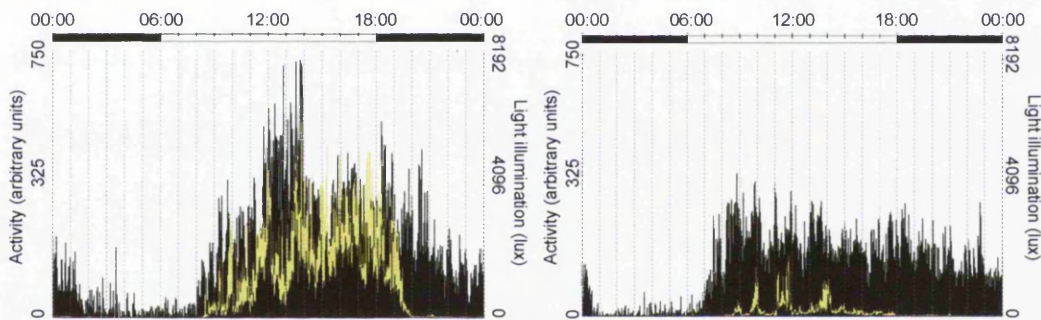

Figure 2.2. Example of the average daily activity profiles measured by the actiwatch. (Activity = black, light illumination = yellow).

Subject 1

Subject 2

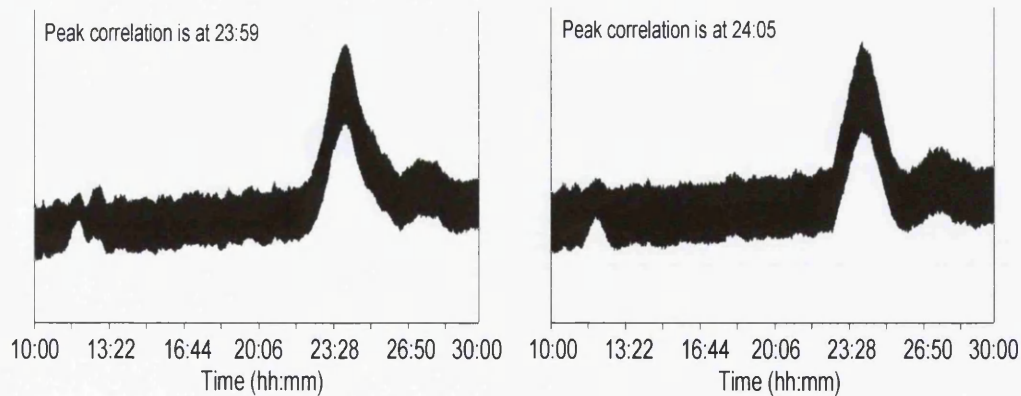

Figure 2.3. Example periodograms of the average period length of the activity rhythm, measured by the actiwatch. Peak correlation = average period of the activity rhythm.

Bedtime (h)	23:45 ± 00:55
Get up time (h)	08:20 ± 00:45
Time in bed (h)	08:45 ± 00:41
Sleep start (h)	00:19 ± 01:00
Sleep end (h)	07:59 ± 00:47
Assumed sleep time (h)	07:57 ± 00:46
Actual sleep time (h)	07:01 ± 00:40
Actual sleep % (%)	87.15 ± 2.46
Actual wake time (h)	00:59 ± 00:13
Actual wake % (%)	12.85 ± 2.46
Wake bouts (#)	41.15 ± 9.25
Sleep bout duration (min)	15.75 ± 22.08
Wake bout duration (min)	01.30 ± 0.61
Sleep efficiency (%)	79.09 ± 4.88
Sleep latency (h)	0.44 ± 0.37

Table 2.2. Summary of the actigraphically assessed sleep parameters (means and standard deviations). Time in bed = difference between get up time and bed time; Assumed sleep time = difference between sleep end and sleep start, Actual sleep time = assumed sleep minus periods of wakefulness during the night; Actual sleep % = percentage of sleep between sleep start and sleep end. Actual wake time = hours of wakefulness during assumed sleep time; Actual wake % = percentage of wakefulness during assumed sleep time; Wake bouts (number of) = number of times participant wakes during sleep; Sleep bout duration = average length of uninterrupted sleep between two consecutive awakenings; Wake bout duration = mean duration of periods of wakefulness; Sleep efficiency = percentage of sleep between bed time and sleep end; Sleep latency = the time it takes from bed time to sleep start.

24 Hours			12am - 6am		
Average illumination mean \pm SD	Maximum illumination, mean \pm SD	Time above 100 lux / minutes, mean \pm SD	Average illumination mean \pm SD	Maximum illumination mean \pm SD	Time above 100 lux / minutes, mean \pm SD
366.42 \pm 458.22	14800.21 \pm 7977.85	292.30 \pm 187.27	2.29 \pm 4.27	706.23 \pm 1804.96	1.84 \pm 4.73

Table 2.3. Light exposure (lux) measured by the actiwatches worn by study participants (means and standard deviations).

2.3.2 Endocrine circadian rhythms

Subjects were assayed for salivary cortisol and melatonin and rhythmicity was assessed by co-sinor analysis. Salivary cortisol levels were significantly rhythmic ($P < 0.05$), with 59.5% rhythm and an acrophase of 9.17 hrs ($n=10$, figure 2.4, table 2.4). Salivary melatonin did not exhibit significant rhythmicity ($P=0.268$), although percentage rhythm was 67.6% ($n=4$, figure 2.5, table 2.4).

	N	Percentage Rhythm (%)	P	Mesor (a.u)	Amplitude (a.u)	C.I. Amplitude (a.u)	Acrophase (h)	C.I. Acrophase (a.u)
Cortisol	10	59.5	<0.05	0.24±0.03	0.24±0.1	0.0, 0.5	9.17	5.27, 11.4
Melatonin	4	67.6	0.269	3.78±0.81	3.94±1.4	0.0, 0.0	5.08	0.0, 0.0
Total RNA Concentration	14	49.6	<0.01	23.686 ±3.260	9.739 ±2.363	2.932, 16.620	4.69	1.92, 6.8
Non-normalised GAPDH	6	52.8	<0.05	27.06±0.39	0.94±0.3	0.0, 2.2	18.38	14.85, 1.4
Non-normalised BMAL1	13	48.5	<0.05	3.75±0.63	3.00±1.1	0.1, 6.2	4.8	3.08, 11.82
BMAL1 normalised to GAPDH	6	50.8	0.577	3.05±1.84	1.83±1.5	0.0, 0.0	8.3	0.0, 0.0
BMAL1 normalised to total RNA concentration	8	42.0	0.133	3.17±0.66	1.82±1.1	0.0, 0.0	4.2	0.0, 0.0
Non-normalised PER2	6	53.1	0.134	8.80±3.31	9.65±4.9	0.0, 0.0	3.59	0.0, 0.0
PER2 normalised to GAPDH	5	48	0.699	6.04±4.96	4.53±4.6	0.0, 0.0	13.31	0.0, 0.0
PER2 normalised to total RNA concentration	5	40.5	0.608	4.85±1.69	5.28±4.3	0.0, 0.0	5.51	0.0, 0.0
Non-normalised PER1	4	52.1	0.297	3.46±1.15	1.18±0.8	0.0, 0.0	5.57	0.0, 0.0
PER1 normalised to total RNA concentration	3	73.3	0.672	2.78±0.40	0.89±1.0	0.0, 0.0	11.83	0.0, 0.0

Table 2.4. Chronometrics of the average 24-hour profiles of cortisol, melatonin, *GAPDH*, *BMAL1*, *PER2*, *PER1* and total mRNA concentration, assessed by co-sinor analysis. For the *BMAL1* and *PER2* profiles, non-normalised, and normalised data to both *GAPDH* expression and total mRNA are shown. For *PER1* non-normalised data and data normalised to total mRNA concentration are shown. The profiles of cortisol, total mRNA concentration, and non-normalised *GAPDH* and *BMAL1* expression are significantly rhythmic. a.u.=arbitrary units.

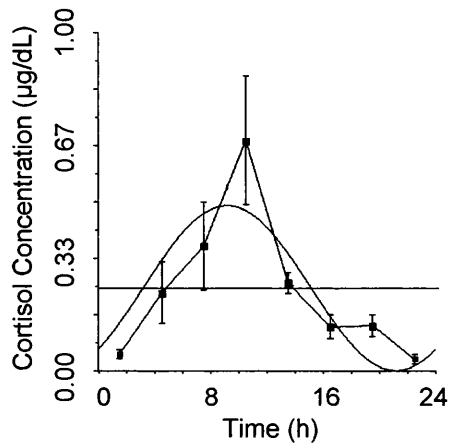
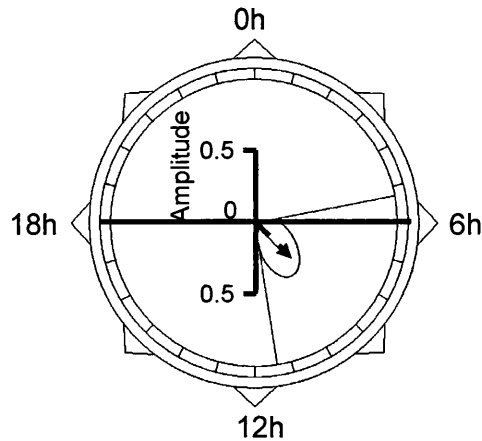
A**B****C**

	<i>Cosinor Fit</i>	<i>% Rhythm</i>	<i>MESOR</i>	<i>AMP</i>	<i>CI AMP</i>	<i>Acrophase</i>	<i>CI Acrophase</i>
N = 10	P=0.018	59.5	0.24±0.03	0.24±0.1	0.0, 0.5	9.17h	5.27, 11.4

Figure 2.4. Co-sinor analysis of salivary cortisol. **(A)** Chronogram of salivary cortisol across the 24 hour cycle. The fitted dark line represents the co-sine wave of best fit with a 24 hour period. The horizontal line represents the MESOR. **(B)** Polargram of the phase/amplitude relationship for salivary cortisol. Length of the dotted black vector indicates amplitude of circadian rhythm and the orientation of this vector represents the acrophase for the control group. 95% confidence interval for the combined amplitude and acrophase are represented by elliptical area around the vector tip, indicated by lightly dashed line. The error ellipse does not overlap the zero point, indicating a significant co-sinor fit for the data on a 24h time-base. **(C)** Chronometrics of salivary cortisol 24-hour profile. % rhythm refers to the percentage of variance in the population data that is explained by regression with the 24h co-sine wave of best fit. AMP is the amplitude of the rhythm, CI AMP is the 95% confidence interval for the amplitude, Acrophase is the time of the peak of the rhythm, CI Acrophase is the 95% confidence interval for the amplitude.

A

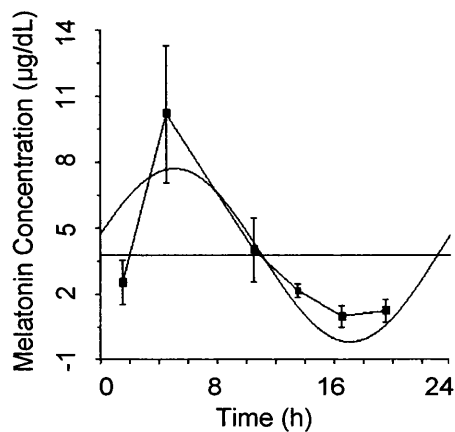

B

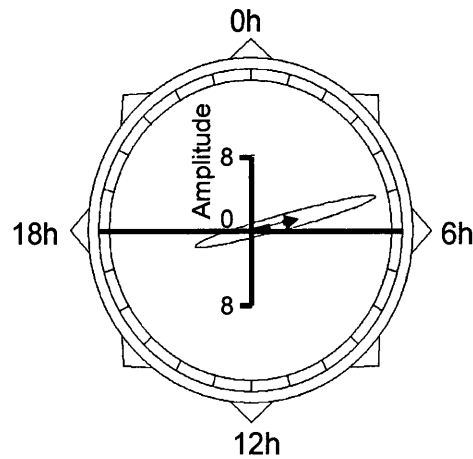

C

	<i>Cosinor Fit</i>	<i>% Rhythm</i>	<i>MESOR</i>	<i>AMP</i>	<i>CI AMP</i>	<i>Acrophase</i>	<i>CI Acrophase</i>
N = 4	P=0.268	67.6	3.78 ± 0.81	3.94 ± 1.4	0.0, 0.0	5.08h	0.0, 0.0

Figure 2.5. Co-sinor analysis of salivary melatonin. **(A)** Chronogram of salivary melatonin across the 24 hour cycle. The fitted dark line represents the co-sine wave of best fit with a 24 hour period. The horizontal line represents the MESOR. **(B)** Polargram of the phase/amplitude relationship for salivary melatonin. Length of the dotted black vector indicates amplitude of circadian rhythm and the orientation of this vector represents the acrophase for the control group. 95% confidence interval for the combined amplitude and acrophase are represented by elliptical area around the vector tip, indicated by lightly dashed line. The error ellipse covers the zero point of amplitude, indicating a non-significant circadian fit for the observed data. **(C)** Chronometrics of salivary melatonin 24-hour profile. Abbreviations are as figure 2.4.

2.3.3 RNA analysis

Experion electrophoresis analysis measured an average concentration of total mRNA extracted from the oral mucosa samples across all of the time-points of 24.31 ± 12.88 ng/ μ l. RNA integrity was assessed by means of assessment of the 28S:18S ratio and the RQI score. The average 28S:18S ratio was 1.80 ± 0.95 and the average RQI was 2.33 ± 0.54 . The total concentration of RNA across the time-course of sampling exhibited significant rhythmicity ($P < 0.01$) with an acrophase of 4.69 hrs and a

percentage rhythm of 49.6%, as assessed by co-sinor analysis (n=14, figure 2.6). Although no variation in the degree of degradation was observed (figure 2.7).

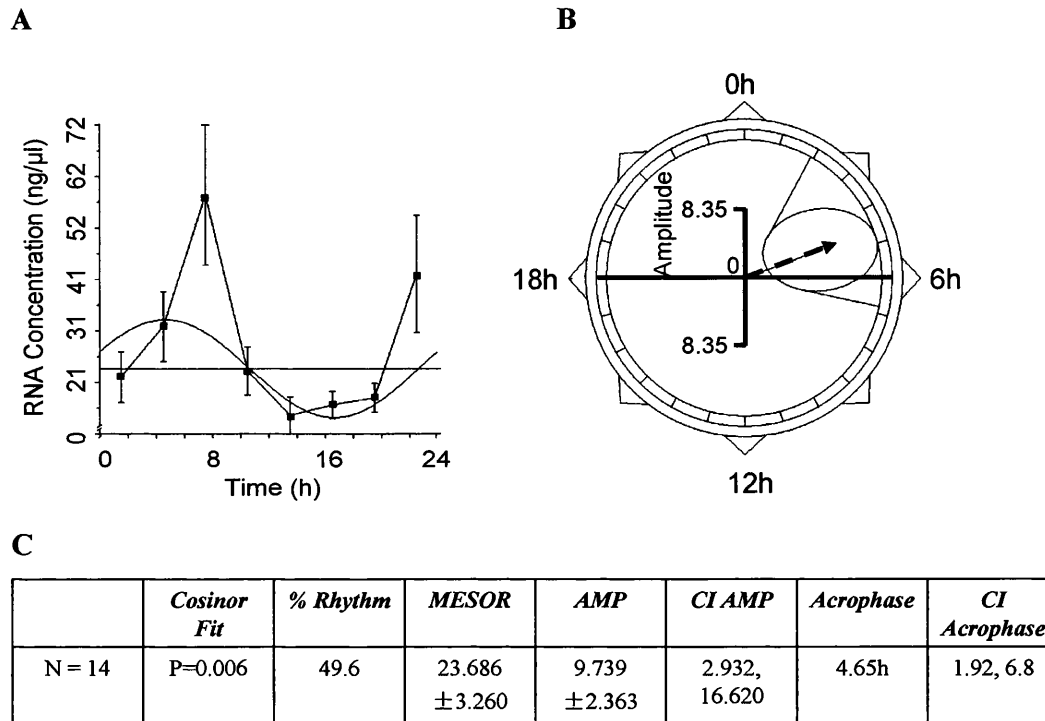
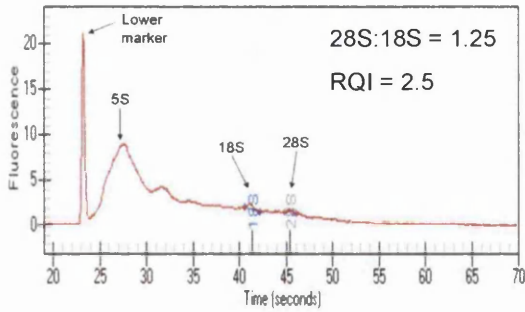
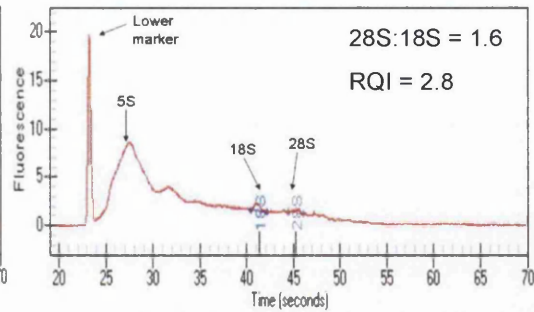

Figure 2.6. Co-sinor analysis of total mRNA concentration. **(A)** Chronogram of the RNA concentration of the oral mucosa samples across the 24 hour cycle. The fitted dark line represents the co-sine wave of best fit with a 24 hour period. The horizontal line represents the MESOR. **(B)** Polargram of the phase/amplitude relationship for RNA concentration. Length of the dotted black vector indicates amplitude of circadian rhythm and the orientation of this vector represents the acrophase for the control group. 95% confidence interval for the combined amplitude and acrophase are represented by elliptical area around the vector tip, indicated by lightly dashed line. The error ellipse does not overlap the zero point, indicating a significant co-sinor fit for the data on a 24h time-base. **(C)** Chronometrics of the total mRNA concentration profile. Abbreviations are as figure 2.4.

00:00



04:00



08:00

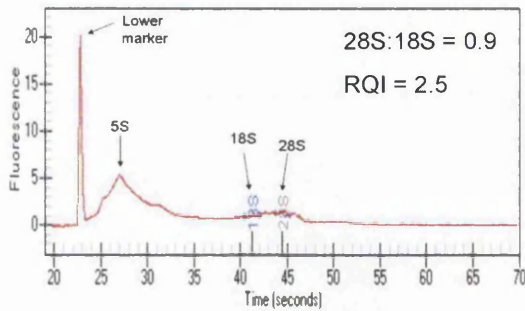

12:00

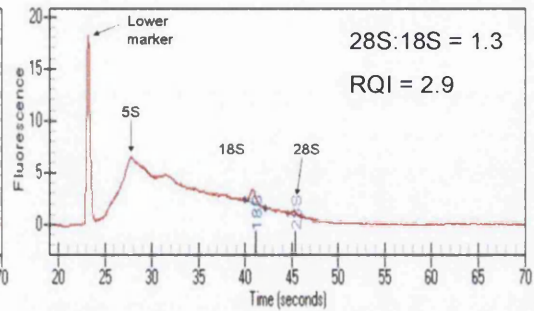

16:00

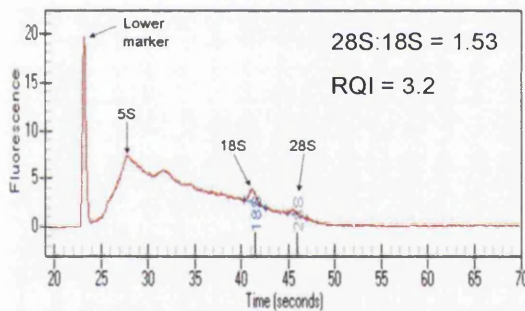

20:00

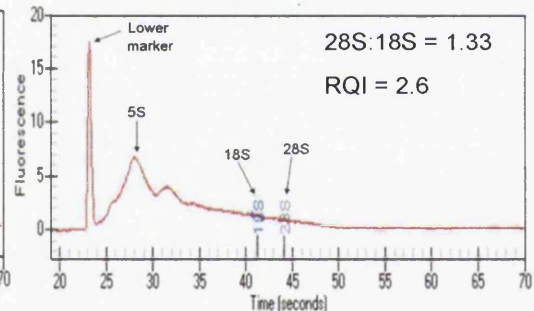

Figure 2.7. Example chromatograms obtained from the Experion electrophoresis analysis of the RNA samples collected over the 24 hour period, showing the degree of RNA degradation did not vary considerably over the 24 hour period. A lower threshold baseline and 5S peak, and greater 28S:18S ratio and RQI is indicative of intact RNA (Perfectly intact RNA: 28S:18S=2.0, RQI=10). Average 28S:18S and RQI of all the samples was 1.80 ± 0.95 and 2.33 ± 0.54 respectively.

2.3.4 Normalisation of clock gene expression

Expression levels of the house-keeping gene *GAPDH* and clock genes were quantified by RT-PCR and the data was tested for significant rhythmicity by co-sinor analysis. Non-normalised raw *GAPDH* expression showed a significant oscillation ($P < 0.05$), with an acrophase of 18.38 hrs and percentage rhythm of 52.8% ($n=6$, figure 2.8, table 2.4). Prior to normalisation, the raw non-normalised *BMAL1* data was significantly rhythmic, ($P < 0.05$) with an acrophase of 4.8hrs and a percentage rhythm of 48.5% ($n=13$, figure 2.9, table 2.4). Non-normalised *PER2* expression did not show significant rhythmicity ($P=0.134$) although percentage rhythm of the data was 53.1% ($n=6$, figure 2.10, table 2.4). Non-normalised *PER1* expression also did not show significant rhythmicity ($P=0.297$), and the percentage rhythm of the data was 52.1% ($n=4$, figure 2.11, table 2.4).

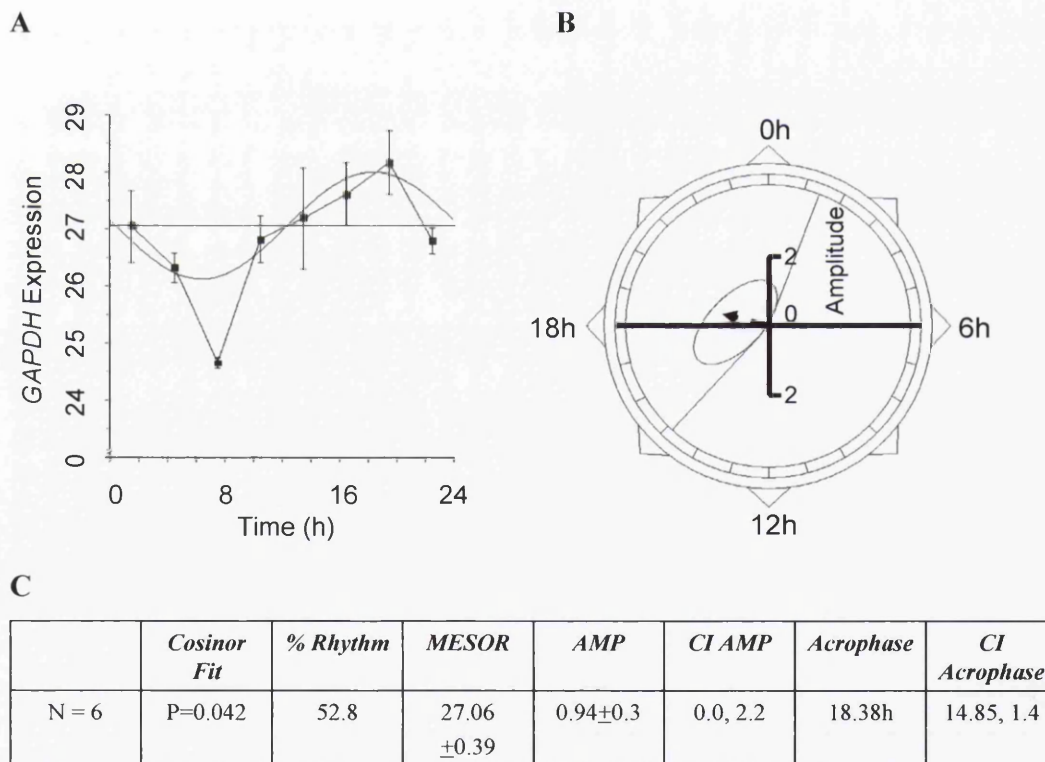

Figure 2.8. Co-sinor analysis of non-normalised raw *GAPDH* expression levels. **(A)** Chronogram of *GAPDH* expression levels in the oral mucosa samples across the 24 hour cycle. The fitted dark line represents the co-sine wave of best fit with a 24 hour period. The horizontal line represents the MESOR. **(B)** Polargram of the phase/amplitude relationship for *GAPDH* expression levels. Length of the dotted

black vector indicates amplitude of circadian rhythm and the orientation of this vector represents the acrophase. 95% confidence interval for the combined amplitude and acrophase are represented by elliptical area around the vector tip, indicated by lightly dashed line. The error ellipse does not overlap the zero point, indicating a significant co-sinor fit for the data on a 24h time-base. (C) Chronometrics of the *GAPDH* expression profile. Abbreviations as outlined in figure 2.4.

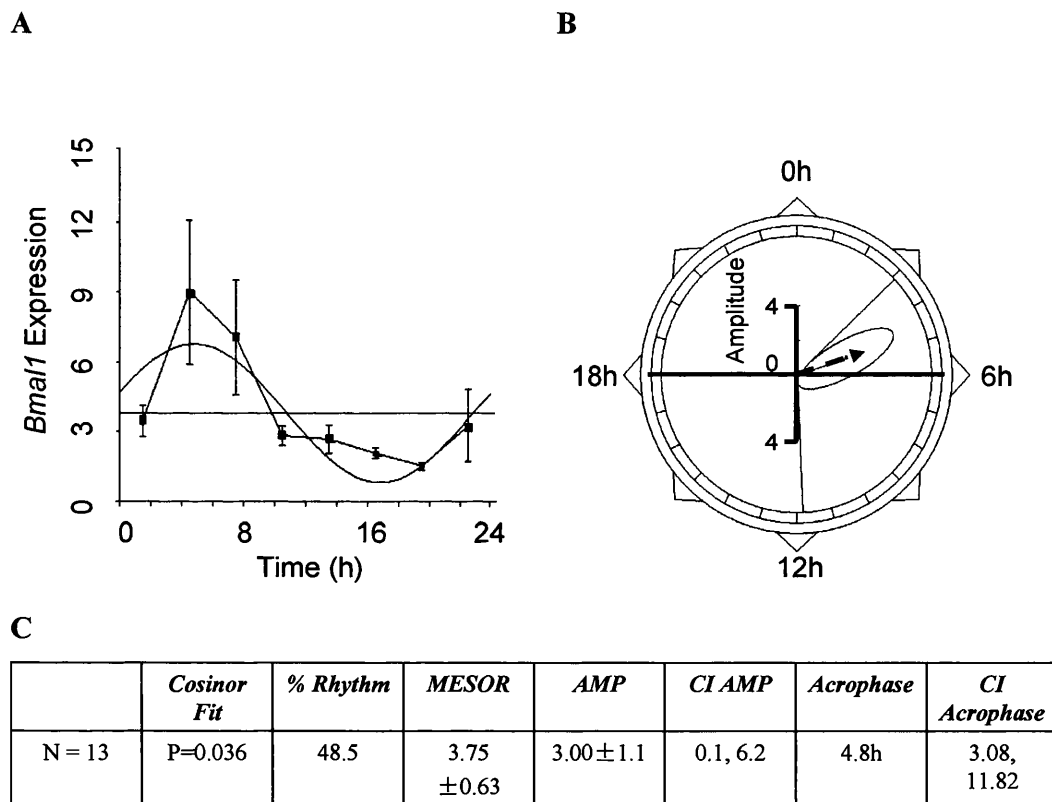
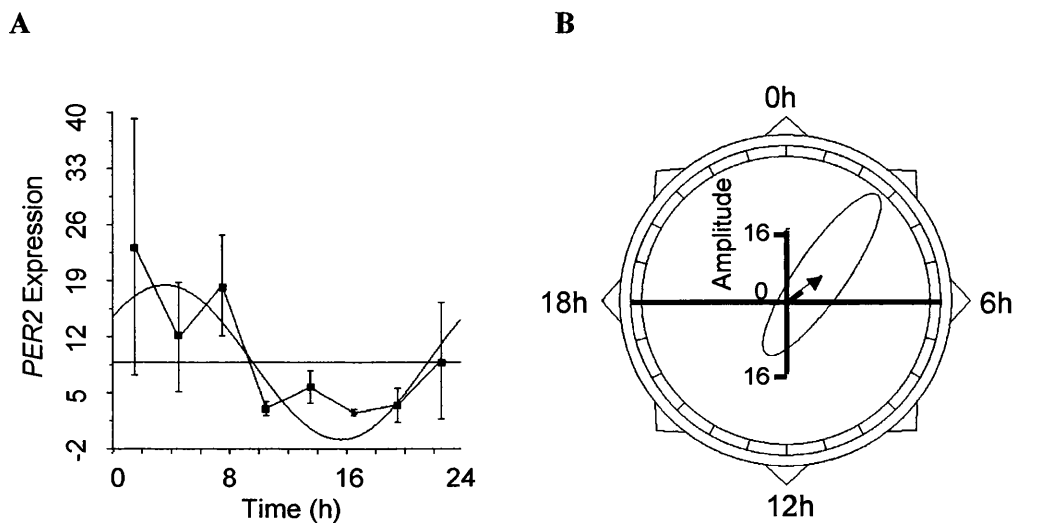
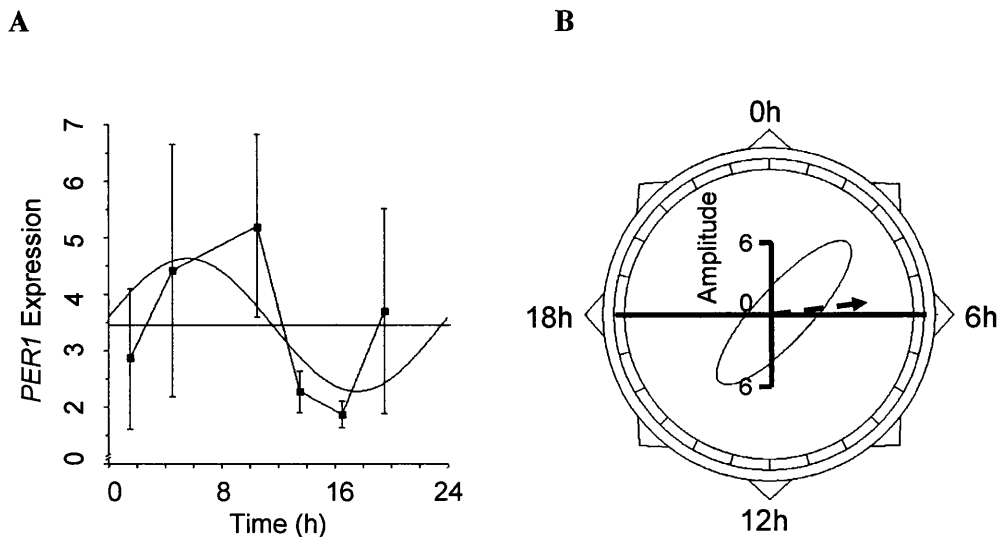

Figure 2.9. Co-sinor analysis of non-normalised raw *BMAL1* expression levels. (A) Chronogram of *BMAL1* expression levels in the oral mucosa samples across the 24 hour cycle. The fitted dark line represents the co-sine wave of best fit with a 24 hour period. The horizontal line represents the MESOR. (B) Polargram of the phase/amplitude relationship for *BMAL1* expression levels. Length of the dotted black vector indicates amplitude of circadian rhythm and the orientation of this vector represents the acrophase. 95% confidence interval for the combined amplitude and acrophase are represented by elliptical area around the vector tip, indicated by lightly dashed line. The error ellipse does not overlap the zero point, indicating a significant co-sinor fit for the data on a 24h time-base. (C) Chronometrics of the *BMAL1* expression profile. Abbreviations as outlined in figure 2.4.



	<i>Cosinor Fit</i>	<i>% Rhythm</i>	<i>MESOR</i>	<i>AMP</i>	<i>CI AMP</i>	<i>Acrophase</i>	<i>CI Acrophase</i>
N = 6	P=0.134	53.1	8.80±3.31	9.65±4.9	0.0, 0.0	3.59h	0.0, 0.0

Figure 2.10. Co-sinor analysis of non-normalised raw *PER2* expression levels. **(A)** Chronogram of *PER2* expression levels in the oral mucosa samples across the 24 hour cycle. The fitted dark line represents the co-sine wave of best fit with a 24 hour period. The horizontal line represents the MESOR. **(B)** Polargram of the phase/amplitude relationship for *PER2* expression levels. Length of the dotted black vector indicates amplitude of circadian rhythm and the orientation of this vector represents the acrophase. 95% confidence interval for the combined amplitude and acrophase are represented by elliptical area around the vector tip, indicated by lightly dashed line. The error ellipse covers the zero point of amplitude, indicating a non-significant circadian fit for the observed data. **(C)** Chronometrics of the *PER2* expression profile. Abbreviations as outlined in figure 2.4.



C

	<i>Cosinor Fit</i>	<i>% Rhythm</i>	<i>MESOR</i>	<i>AMP</i>	<i>CIAMP</i>	<i>Acrophase</i>	<i>CI Acrophase</i>
N = 4	P=0.297	52.1	3.46 ± 1.15	1.18 ± 0.8	0.0, 0.0	5.57h	0.0, 0.0

Figure 2.11. Co-sinor analysis of non-normalised raw *PER1* expression levels. **(A)** Chronogram of *PER1* expression levels in the oral mucosa samples across the 24 hour cycle. The fitted dark line represents the co-sine wave of best fit with a 24 hour period. The horizontal line represents the MESOR. **(B)** Polargram of the phase/amplitude relationship for *PER1* expression levels. Length of the dotted black vector indicates amplitude of circadian rhythm and the orientation of this vector represents the acrophase. 95% confidence interval for the combined amplitude and acrophase are represented by elliptical area around the vector tip, indicated by lightly dashed line. The error ellipse covers the zero point of amplitude, indicating a non-significant circadian fit for the observed data. **(C)** Chronometrics of the *PER1* expression profile. Abbreviations as outlined in figure 2.4.

To compare the use of normalisation to *GAPDH* expression to total mRNA concentration, the expression of the clock genes *BMAL1*, *PER2* and *PER1* were normalised via both methods. *BMAL1* expression normalised to both *GAPDH* expression (n=6) and to total mRNA concentration (n=8) did not exhibit significant rhythmicity (P=0.577 and P=0.133 respectively, figures 2.12-2.13, table 2.4). Although percentage rhythm of the data was 50.8% when normalised to *GAPDH* expression and 42.0% when normalised to total mRNA concentration (figures 2.12-

2.13, table 2.4). *PER2* expression also did not exhibit significant rhythmicity when normalised by either method ($P=0.669$ and $P=0.608$ respectively, $n=5$ in both cases, figures 2.14-2.15, table 2.4). Percentage rhythm of the data was again greater when normalised to *GAPDH* expression (48%) in comparison to total mRNA concentration (40.5%, figures 2.14-2.15, table 2.4). Only two sets of *PER1* expression data normalised to *GAPDH* expression were available and therefore the data was assessed by co-sinor analysis individually (table 2.5). Data set 1 exhibited a significant circadian rhythm ($P<0.01$), with an acrophase of 4.52hrs and 97.1% rhythm (table 2.5). Whereas data set 2 did not exhibit rhythmic *PER1* expression ($P=0.102$), with a percentage rhythm of 78.2% (table 2.5). *PER1* expression normalised to total mRNA concentration was also not significantly rhythmic ($P=0.672$), although the data had a percentage rhythm of 73.3% ($n=3$, figure 2.16, table 2.4).

Although in almost all cases neither normalisation method produced significantly rhythmic data, (apart from *GAPDH* normalised *PER1* expression of data set 1, $P<0.01$, table 2.5), the expression of each clock gene showed the greatest percentage rhythm when normalised to *GAPDH* expression as oppose to total mRNA concentration (figures 2.12-2.16, table 2.4 and 2.5).

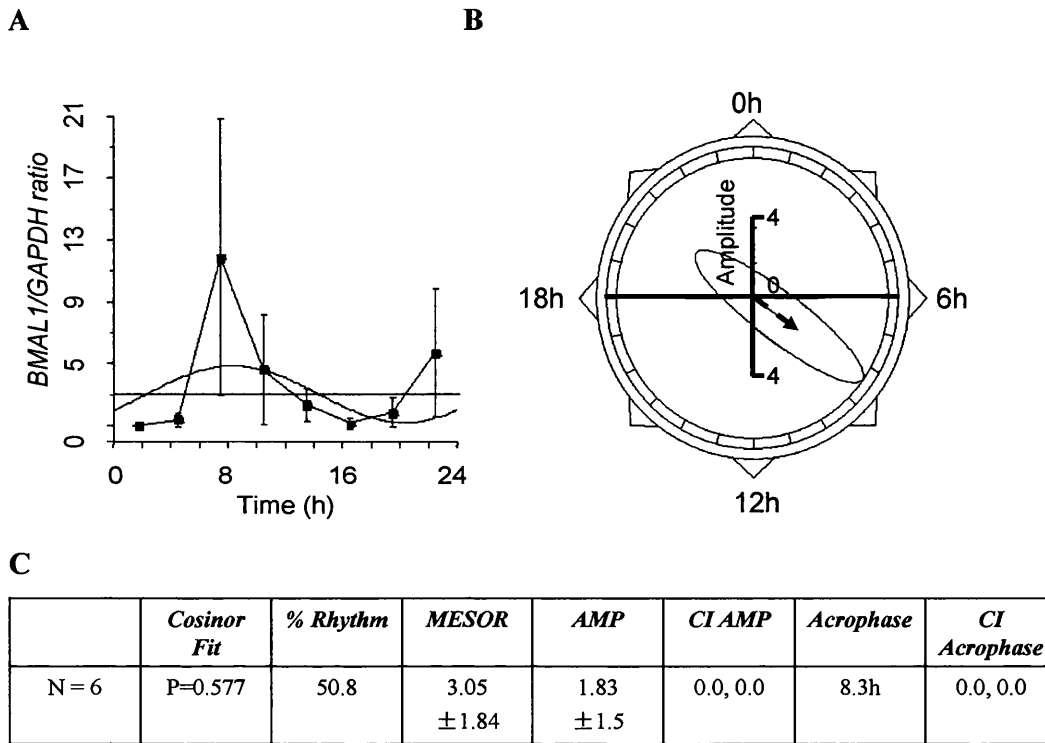

Figure 2.12. Co-sinor analysis of *BMAL1* expression normalised to *GAPDH* expression. **(A)** Chronogram of *BMAL1* expression in the oral mucosa samples across the 24 hour cycle. The fitted dark line represents the co-sine wave of best fit with a 24 hour period. The horizontal line represents the MESOR. **(B)** Polargram of the phase/amplitude relationship of the *BMAL1* expression levels. Length of the dotted black vector indicates amplitude of circadian rhythm and the orientation of this vector represents the acrophase. 95% confidence interval for the combined amplitude and acrophase are represented by elliptical area around the vector tip, indicated by lightly dashed line. The error ellipse covers the zero point of amplitude, indicating a non-significant circadian fit for the observed data. **(C)** Chronometrics of the profile of *BMAL1* expression. Abbreviations as outlined in figure 2.4.

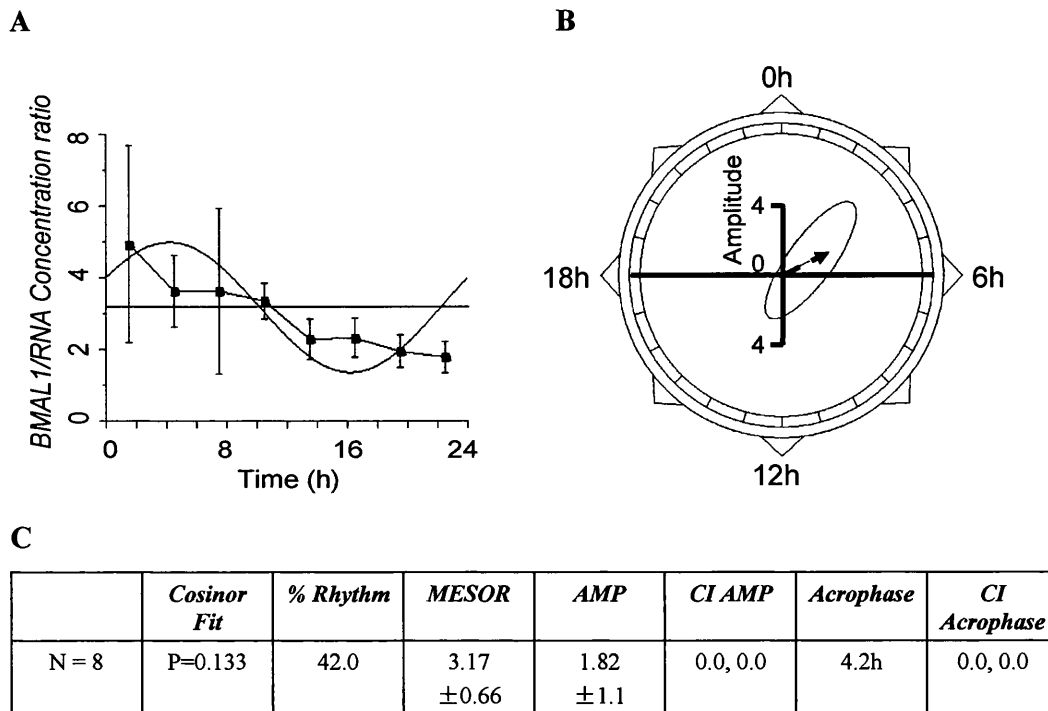
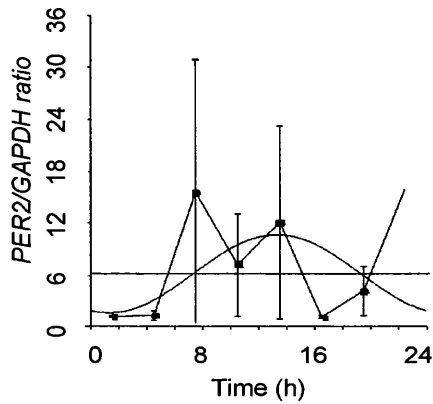
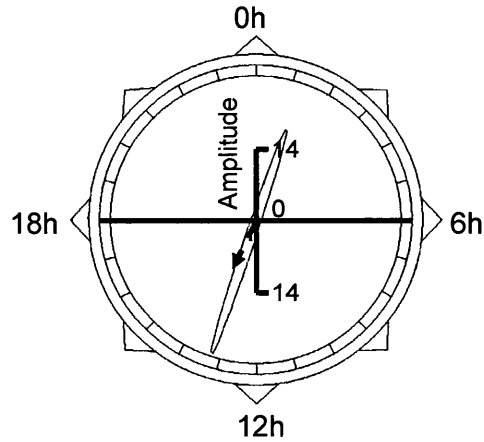

Figure 2.13. Co-sinor analysis of *BMAL1* expression normalised to total mRNA concentration. **(A)** Chronogram of *BMAL1* expression in the oral mucosa samples across the 24 hour cycle. The fitted dark line represents the co-sine wave of best fit with a 24 hour period. The horizontal line represents the MESOR. **(B)** Polargram of the phase/amplitude relationship of the *BMAL1* expression level. Length of the dotted black vector indicates amplitude of circadian rhythm and the orientation of this vector represents the acrophase. 95% confidence interval for the combined amplitude and acrophase are represented by elliptical area around the vector tip, indicated by lightly dashed line. The error ellipse covers the zero point of amplitude, indicating a non-significant circadian fit for the observed data. **(C)** Chronometrics of the profile of *BMAL1* expression. Abbreviations as outlined in figure 2.4.

A



B



C

	<i>Cosinor Fit</i>	<i>% Rhythm</i>	<i>MESOR</i>	<i>AMP</i>	<i>CI AMP</i>	<i>Acrophase</i>	<i>CI Acrophase</i>
N = 5	P=0.669	48.0	6.04 ±4.96	4.53 ±4.6	0.0, 0.0	13.31h	0.0, 0.0

Figure 2.14. Co-sinor analysis of *PER2* expression normalised to *GAPDH* expression. **(A)** Chronogram of *PER2* expression in the oral mucosa samples across the 24 hour cycle. The fitted dark line represents the co-sine wave of best fit with a 24 hour period. The horizontal line represents the MESOR. **(B)** Polargram of the phase/amplitude relationship of the *PER2* expression level. Length of the dotted black vector indicates amplitude of circadian rhythm and the orientation of this vector represents the acrophase. 95% confidence interval for the combined amplitude and acrophase are represented by elliptical area around the vector tip, indicated by lightly dashed line. The error ellipse covers the zero point of amplitude, indicating a non-significant circadian fit for the observed data. **(C)** Chronometrics of the profile of *PER2* expression. Abbreviations as outlined in figure 2.4.

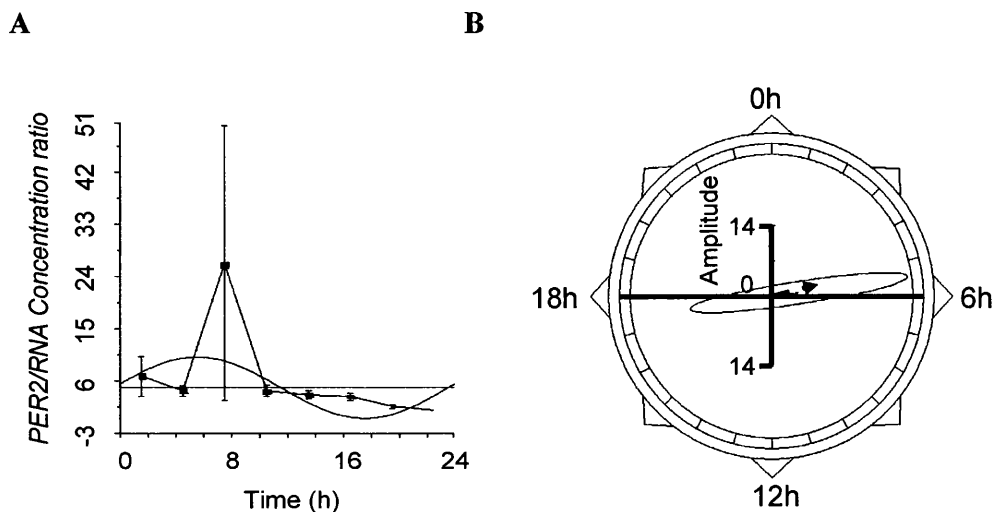

	<i>Cosinor Fit</i>	<i>% Rhythm</i>	<i>MESOR</i>	<i>AMP</i>	<i>CI AMP</i>	<i>Acrophase</i>	<i>CI Acrophase</i>
N = 5	P=0.608	40.5	4.85 ±1.69	5.28 ±4.3	0.0, 0.0	5.51h	0.0, 0.0

Figure 2.15. Co-sinor analysis of *PER2* expression to total mRNA concentration. **(A)** Chronogram of *PER2* expression in the oral mucosa samples across the 24 hour cycle. The fitted dark line represents the co-sine wave of best fit with a 24 hour period. The horizontal line represents the MESOR. **(B)** Polargram of the phase/amplitude relationship of the *PER2* expression level. Length of the dotted black vector indicates amplitude of circadian rhythm and the orientation of this vector represents the acrophase. 95% confidence interval for the combined amplitude and acrophase are represented by elliptical area around the vector tip, indicated by lightly dashed line. The error ellipse covers the zero point of amplitude, indicating a non-significant circadian fit for the observed data. **(C)** Chronometrics of the profile of *PER2* expression. Abbreviations as outlined in figure 2.4.

	<i>Cosinor Fit</i>	<i>% Rhythm</i>	<i>MESOR</i>	<i>AMP</i>	<i>CI AMP</i>	<i>Acrophase</i>	<i>CI Acrophase</i>
Data Set 1	P=0.005	97.1	0.97±0.01	0.13±0.01	(0.1, 0.2)	4.52±0.38	(3.4, 5.7)
Data Set 2	P=0.102	78.2	1.03±0.12	0.57±0.16	(0.0, 0.0)	4.29±1.16	(0.0, 0.0)

Table 2.5. Co-sinor analysis of *PER1* expression to *GAPDH* expression. **(A)** Chronometrics of the profile of *PER1* expression for data set 1 and 2. Abbreviations as outlined in figure 2.4. No chronogram or polargram were available due to the co-sinor analysis of individual data sets.

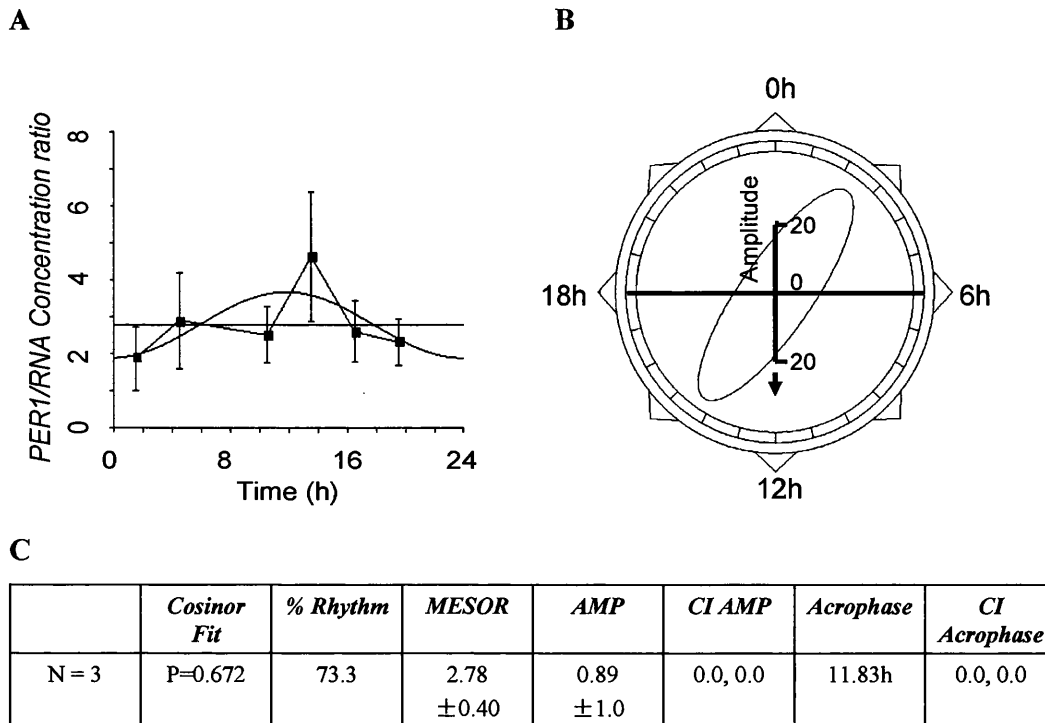

Figure 2.16. Co-sinor analysis of *PER1* expression to total mRNA concentration. **(A)** Chronogram of *PER1* expression in the oral mucosa samples across the 24 hour cycle. The fitted dark line represents the co-sine wave of best fit with a 24 hour period. The horizontal line represents the MESOR. **(B)** Polargram of the phase/amplitude relationship of the *PER1* expression level. The vector indicating amplitude and acrophase is not visible due to the low amplitude (0.89 ± 1.0). 95% confidence interval for the combined amplitude and acrophase are represented by elliptical area around the vector tip, indicated by lightly dashed line. The error ellipse covers the zero point of amplitude, indicating a non-significant circadian fit for the observed data. **(C)** Chronometrics of the profile of *PER1* expression. Abbreviations as outlined in figure 2.4.

2.3.5 Correlations of the behavioural data with the endocrine and molecular measures

To investigate the relationship of the rest-activity rhythm and actigraphically assessed sleep measures with the profiles of the molecular and endocrine circadian rhythms, correlations between actigraphic measures and the chronometrics of the *GAPDH* normalised clock gene expression and salivary melatonin and cortisol profiles were examined by two-tailed Pearson's product moment correlation. An inverse relationship was demonstrated between L5o and the acrophase of *PER2* expression ($r=-0.950$, $P<0.05$, figure 2.17A). The acrophase of *BMAL1* significantly correlated with percentage of actual sleep ($r=0.883$, $P<0.05$, figure 2.17B), and hence there was an inverse relationship of the acrophase of *BMAL1* expression with percentage of actual time awake ($r=-0.883$, $P<0.05$, figure 2.17C). The acrophase of the salivary cortisol rhythm was inversely correlated with the actigraphic period deviation ($r=-0.890$, $P<0.01$, figure 2.17D) and significantly correlated with the time of sleep start ($r=0.842$, $P<0.01$, figure 2.17E).

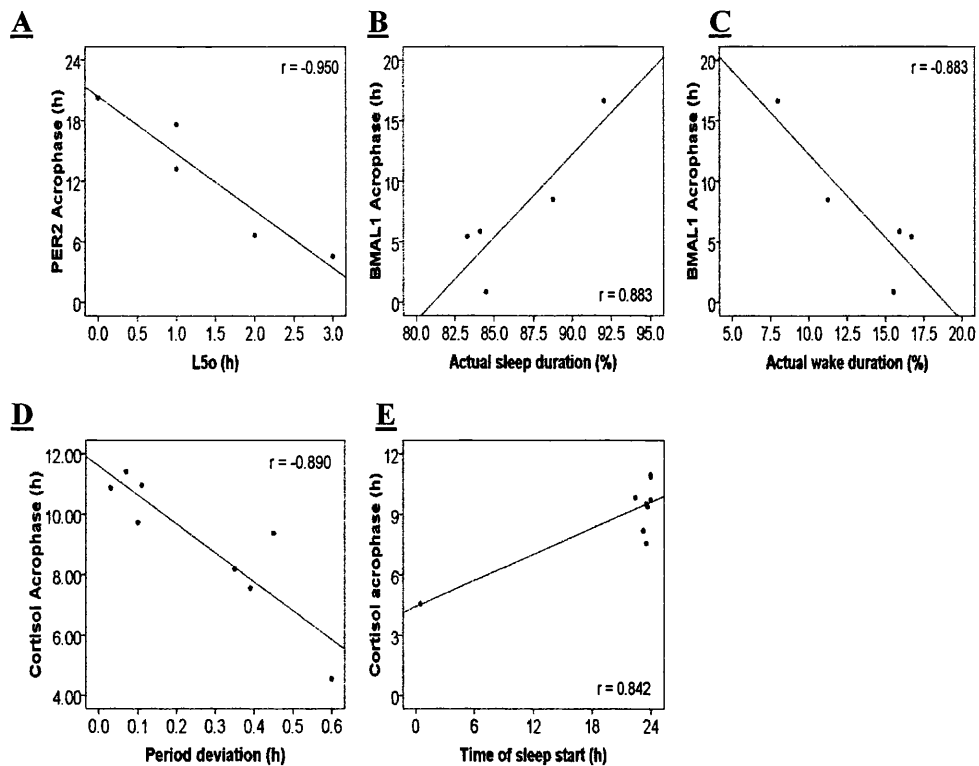

Figure 2.17. Significant correlations between the chronometrics of the actigraphic circadian rhythm and the chronometrics of the *BMAL1*, *PER2* and cortisol. (331 correlations between the chronometrics of the actigraphic rhythm and the chronometrics of the *BMAL1*, *PER2*, cortisol and melatonin rhythms did not reach significance). L5o = time of onset of the least active five hours; Actual sleep duration % = percentage of time spent in bed asleep; Actual wake duration % = percentage of time spent in bed awake; Period deviation = difference in period length from 24 hours.

2.4 Discussion

2.4.1 Actigraphy and chronotype

Although not identical, the actigraphic measurements of the rest and activity periods are correlated with sleep and wakefulness periods (Boonstra et al., 2007). Based upon previous actigraphy studies, all the average activity and sleep measures of the subjects in the present study were comparable to those reported of healthy subjects (Jones et al., 2005, Boonstra et al., 2007). These included indicators of sleep continuity and quantity; sleep bout and wake bout durations, number of wake bouts, assumed and actual sleep durations, actual wake duration and percentages of sleep and wakefulness during the sleep time. The time spent awake and asleep, in comparison to the time spent in bed, and the sleep efficiency and sleep latency measures all indicated that the proportion of sleep during the period of rest and the time taken to fall asleep were within the normal range. The amount of activity exhibited over the 24 hours period was also as expected in healthy individuals, as demonstrated by the amplitude, and the activity exhibited in the least 5 active hours and the 10 most active hours. Furthermore the intradaily variability and relative amplitude measures demonstrated a robust rhythm of the rest-activity rhythm. L50, M100 and the acrophase of the rest-activity rhythm indicated that the phase of the behavioural rhythm was as expected in healthy individuals, with onset of the rest period just after midnight, onset of the most active period in the mid morning and peak activity in the mid afternoon. This was further confirmed by the calculated sleep measures, which demonstrated time of sleep end, wake time and get up time in the early morning and bed time and sleep start just before midnight. The average intrinsic period in humans is estimated to be just over 24 hours at 24.18 hours (Czeisler et al., 1999), and the average period of the rest-activity rhythm in the present study fell just short of 24 hours. Importantly the period deviation from 24 hours observed was minimal, and the interdaily stability was within the range of healthy adults, thus indicating efficient coupling of the behavioural rhythm to the 24 hours environmental cycle. The subjects were on average of intermediate chronotype, which is to be expected of healthy adults, as it is documented as the most common chronotype of the healthy human population (Paine et al., 2006), and extremes in chronotype have been associated with psychiatric illness (Mansour et al.,

2005, Lamont et al., 2010). Normal patterns of light exposure were also demonstrated by average and maximum light illumination being minimal during the normal hours of sleep of 12am – 6am in comparison to the full 24 hour period.

2.4.2 Endocrine circadian rhythms

Salivary cortisol levels exhibited a characteristic diurnal rhythm that was significant, with an acrophase in the morning as is widely documented in healthy individuals (Van Someren and Riemersma-Van Der Lek, 2007, Dockray and Steptoe, 2010). Salivary melatonin levels are known to also display a significant diurnal rhythm, with peak levels at ~3am (Arendt and Skene, 2005, Pandi-Perumal et al., 2005). In the present study however a significant rhythm of salivary melatonin was not detected, which is most likely due to the low sample number, although the measurement of percentage rhythm indicated a robust rhythm of melatonin.

2.4.3 RNA analysis

In the present study a non-invasive technique was developed for the simple sampling of oral mucosa for the monitoring of clock gene expression. The advantages of this protocol being that it allows for self-sampling, and so does not require laboratory based sampling and thus, when applied with actigraphy in order to gain objective sleep and motor activity measurements and reference points, allows for a more naturalistic monitoring of these circadian processes. The reliability of the 28S:18S ratio as an indicator of RNA quality is questionable as incorrect identification of the start and end points of the 28S and 18S peaks leads to inaccurate calculations of area resulting in highly variable 28S:18S calculations between identical samples evaluated on independent runs (Imbeaud et al., 2005). Therefore both the 28S:18S ratio and RQI measurements were evaluated in the present study and in both cases this indicated that the RNA extracted from the oral mucosa was of relatively low integrity, although the degree of RNA degradation did not vary greatly across the circadian cycle or between subjects. It is not surprising that the RNA was relatively degraded since it originates from the oral mucosa, a tissue that is subject to regular abrasion (Warburton et al., 2005) and surrounded by an environment of high RNase activity (Driemel et al., 2007). Furthermore it has been acknowledged in the

literature that a 28S:18S ratio of 2.0 indicating completely intact rRNA is very difficult to meet in RNA derived from clinical samples (Imbeaud et al., 2005).

2.4.4 Normalisation of clock gene expression

The concentration of total mRNA extracted from the oral mucosa in the present study was shown to oscillate over the 24 hour period with a significant rhythm. This could be explained in part by the high degree of abrasion and hence cell proliferation of the oral mucosa (Angelov et al., 2004, Warburton et al., 2005). Total mRNA is known to be increased in highly proliferating tissues (Bustin et al., 2005) and a number of aspects of the cell cycle, inflammatory and healing processes have been shown to be in part under circadian control (Lavker et al., 1991, Bjarnason et al., 1999, Irwin et al., 2006, Wang et al., 2006), and so it could therefore be postulated that total mRNA amounts may oscillate over the 24 hour cycle as a consequence of this. Prior to normalisation, the profiles of the housekeeping gene *GAPDH* and the clock gene *BMAL1* were also shown to oscillate, whilst both *PER2* and *PER1* expression were not significantly rhythmic prior to normalisation. It is quite probable that the oscillation in total mRNA quantity could play a role in this significant rhythm of *GAPDH* expression, which may otherwise not be expressed with significant rhythmicity. However *GAPDH* expression has been reported to be under circadian regulation (Shinohara et al., 1998), and furthermore a circadian profile in its expression has been documented in the rodent retinal tissue (Kamphuis et al., 2005). To the contrary however, *GAPDH* has been shown to be constitutively expressed in the human oral mucosa, and is therefore an appropriate house-keeping gene for normalisation of gene expression in this tissue (Warburton et al., 2005, Cajochen et al., 2006).

To further investigate the merits of normalising to a housekeeping gene or to total mRNA amounts, the effects of both methods of normalisation upon the expression of the clock genes; *BMAL1*, *PER2* and *PER1* were assessed. The expression of all three clock genes was not significantly rhythmic after normalisation to either *GAPDH* expression or total mRNA amounts, which can most probably be attributed to the low samples numbers in each case. However, the percentage rhythms of clock gene expression were relatively high, indicating the potential usefulness of the technique

when applied to a larger sample population. Furthermore, the percentage rhythms of *BMAL1* and *PER2* were greatest when *GAPDH* normalisation was implemented as oppose to normalisation to total mRNA amounts, which may be a direct consequence of the robust oscillation of total mRNA amounts across the circadian cycle. It was therefore concluded that due to the increased robustness of clock gene expression rhythmicity when normalised to *GAPDH* expression and the observed circadian oscillation of total mRNA concentration in the oral mucosa, that normalising to the expression of *GAPDH* was a more appropriate method of normalisation than using total mRNA concentration. This is in agreement with previous reports that suggest quantification of *GAPDH* expression is an adequate method of normalisation of gene expression in the oral mucosa, since it is constitutively expressed in this tissue (Warburton et al., 2005, Cajochen et al., 2006).

2.4.5 Correlations of the behavioural data with the endocrine & molecular measures

Correlations were observed between a number of actigraphic parameters and the acrophases of the profiles of *PER2* and *BMAL1* expression and salivary cortisol. This therefore indicated potential interactions of the molecular and endocrine circadian rhythms with the circadian rhythm of behaviour, and therefore the potential usefulness of these rhythms as markers of the circadian clock pacemaker, as also demonstrated by the circadian rhythms of clock gene expression in human hair follicle cells (Akashi et al., 2010). Correlations observed in the present study included an inverse relationship of *PER2* acrophase with the time of onset of least activity, indicating that as the acrophase of the *PER2* rhythm increases the time of onset of the rest period becomes earlier. The significant correlation of *BMAL1* acrophase with percentage duration of sleep and the inverse relationship of *BMAL1* acrophase with percentage duration of wakefulness both indicate that the later the *BMAL1* acrophase the longer the duration of time asleep will be. These correlations therefore indicate a potential interaction of the circadian rhythm of clock gene expression with sleep timing and duration. A correlation of the acrophase of the cortisol rhythm with the time of sleep start was observed, thus indicating that as the acrophase of the cortisol rhythm becomes later so too does the time of sleep onset. This observation can be explained by the fact that cortisol plays a key role in the awakening response, with a clear morning peak in cortisol occurring just after

waking (Van Someren and Riemersma-Van Der Lek, 2007). Therefore in individuals exhibiting later phases of behaviour, not only would their time of sleep onset occur later, but so too would their time of waking the following day, in conjunction with a later acrophase of the cortisol rhythm. An inverse relationship was also revealed between the acrophase of the cortisol rhythm and the actigraphic period deviation, which suggests that the further the period of the rest-activity rhythm deviates from 24 hours, the earlier the acrophase of the cortisol rhythm will occur. This would suggest that there is a possible link between the phase of the cortisol rhythm with synchronisation of the circadian activity rhythm to the environmental 24 hour cycle, an assumption which could be plausible due to the known roles of cortisol in the awakening response as mentioned earlier and also its role in the entrainment of the peripheral oscillators (Van Someren and Riemersma-Van Der Lek, 2007). It could therefore be postulated that altered timing of the phase of the cortisol rhythm could not only impact upon the behavioural rhythm, but also perturb the synchronisation of the peripheral oscillators to the master circadian pacemaker.

2.4.6 Conclusions

The subjects included in this study exhibited normal diurnal patterns of rest and activity as indicated by actigraphic measures and intermediate chronotype. The phase of the cortisol rhythm further corroborated this, and actigraphic measures of light illumination revealed that the subjects were exposed to normal patterns of light exposure over the 24 hour period. It can therefore be assumed that the circadian system was intact in these individuals who were exposed to normal patterns of light and social Zeitgebers. RNA extraction from the oral mucosa using the protocol developed in the current study produced RNA of adequate integrity for successful analysis of clock gene expression. The normalisation of clock gene expression to the expression of the housekeeping gene *GAPDH* was shown to be superior to that of total mRNA amounts in the oral mucosa as indicated by the comparison of robustness of clock gene rhythmicity. The relevance of sampling clock gene expression in the oral mucosa was highlighted by the significant correlations observed between a number of actigraphic parameters and the chronometrics of the circadian rhythms of clock gene expression. These findings therefore demonstrated

the usefulness of the technique for further clock gene analysis in a wider clinical population.

**Chapter 3: Circadian rhythms in adult Attention deficit-
/hyperactivity disorder**

Chapter 3: Circadian rhythms in adult Attention deficit-/hyperactivity disorder

3.1 Introduction

Attention deficit-/hyperactivity disorder (ADHD) is a psychiatric condition that can affect both children and adults, with an estimated prevalence of 3 – 7% in school aged children (van West et al., 2009) and 3.4% in adults (Fayyad et al., 2007, Lackschewitz et al., 2008). The disorder is characterised by behavioural and attention difficulties, which can lead to secondary problems such as drug addiction and delinquency in adults (Rosler et al., 2004). Sleep deficits are a prominent characteristic of the disorder, with up to 54% of children and up to 83% of adults with ADHD reporting problems with sleep (Tjon Pian Gi et al., 2003, Sobanski et al., 2008). Actigraphy and polysomnography studies of sleep disturbance in ADHD have demonstrated significant association of sleep disturbance with both childhood and adult ADHD, including delayed sleep onset and difficulties in awakening, increased variability in sleep onset time, sleep duration and true sleep time, increased nocturnal activity, reduced sleep efficiency, more nocturnal awakenings and reduced percentage of REM sleep (Gruber et al., 2000, Boonstra et al., 2007, Rybak et al., 2007, Sobanski et al., 2008). Furthermore, the core symptoms of ADHD; inattention, impulsiveness and restlessness, are known characteristics of sleep deprivation (Corkum et al., 1998) and sleep deprivation has been shown to cause behavioural and cognitive problems (Bonnet, 1985, Babkoff et al., 1991, Gruber et al., 2000). Moreover, the sleep disorder, Idiopathic Chronic Sleep Onset Disorder has been shown to be associated with childhood ADHD (Van der Heijden et al., 2005, Neves and Reimao, 2007).

The circadian clock is responsible for the generation of rhythms of behaviour and physiology on a near twenty-four period base, and plays a key role in determining the rhythm of the sleep/wake cycle (McClung, 2007). The master clock is located in the suprachiasmatic nuclei (SCN) of the anterior hypothalamus and it is entrained to the 24 hour day by receiving light pulses via the retinohypothalamic tract, with further slave oscillators present throughout the brain and periphery (Piggins and Loudon, 2005). SCN output is responsible for driving circadian rhythms in a number of

hormones, including melatonin and cortisol (Reppert and Weaver, 2001, Keller et al., 2006).

The pineal hormone, melatonin, plays a key role in regulating daily rhythms of activity and entrainment of sleep/wake cycles (Wiechmann and Summers, 2008). The nocturnal onset in its secretion, which usually occurs 2 hours in advance of the individuals habitual bedtime, correlates with evening sleepiness and the sleep promoting effect of exogenous melatonin (Tzischinsky et al., 1993, Zhdanova et al., 1996, Zhdanova and Tucci, 2003, Pandi-Perumal et al., 2005). Abnormal rhythms of melatonin secretion have been correlated with childhood ADHD, with children suffering from both ADHD and chronic sleep onset insomnia being shown to exhibit a delayed sleep phase and delayed dim-light melatonin onset (DLMO) (Van der Heijden et al., 2005). Adult ADHD patients suffering from chronic sleep onset insomnia have also been shown to exhibit a delayed DLMO in comparison to adult ADHD patients not suffering from this sleep condition (Van Veen et al., 2010).

In addition to its key role in the hypothalamic-pituitary-adrenal (HPA) axis (Keller et al., 2006), the adrenal glucocorticoid stress hormone cortisol is thought to be involved in the regulation of circadian rhythms (Keller et al., 2006) in particular the entrainment of the peripheral oscillators (Van Someren and Riemersma-Van Der Lek, 2007). The circadian rhythm of cortisol secretion consists of an increase just before waking up in the morning, with a peak within an hour of waking, followed by a decline over the rest of the 24-hour day (Van Someren and Riemersma-Van Der Lek, 2007). Cortisol circadian profiles have been reported to be either unaltered in ADHD (Hirvikoski et al., 2009) or altered in association primarily with the hyperactive subtype of ADHD (Kaneko et al., 1993; Blomqvist et al., 2007).

The molecular basis of circadian rhythm generation consists of positive and negative transcriptional/translational feedback loops of “clock” genes and their protein products (Guilding and Piggins, 2007), which gives rise to twenty-four hour molecular oscillations in a number of behavioural and physiological processes. The transcription factors CLOCK and BMAL1 form a heterodimer thus activating the transcription of *mPer* and *mCry* (Gekakis et al., 1998, van der Horst et al., 1999, Guilding and Piggins, 2007). PER and CRY accumulate thus inhibiting their

CLOCK-BMAL1-dependent transcriptional activation, and the degradation of PER and CRY then leads to a restart of the process, (Reppert and Weaver, 2002, Hastings and Herzog, 2004, Hirota and Fukada, 2004). The rs1801260 C/T single nucleotide polymorphism in the 3'-UTR of the circadian clock gene *CLOCK* has also recently been found to be associated with adult ADHD, where the T-allele was found to be a risk allele for ADHD (Kissling et al., 2008, Xu et al., 2010).

A very apparent behavioural manifestation of circadian phenotypes in humans is diurnal preference, an individual's preference for activity in the morning or evening (Horne and Ostberg, 1977). It has been hypothesised that in individuals with extreme diurnal preferences conflicts between the internal biological clock and environmental/social clocks occur, which could result in the disruption of homeostatic processes and behaviours (Barnard and Nolan, 2008). Presumably desynchronisation of the internal biological clock with the environmental light-dark cycle could occur in individuals with extreme diurnal preference due to an altered exposure to environmental light, the dominant Zeitgeber responsible for entrainment of the circadian system to a 24-hour period. Furthermore, greater eveningness has been associated with self-reported symptoms of ADHD (Rybak et al., 2007).

Based upon these indications that the circadian clock may be compromised in adult ADHD, the aims of this study were therefore to examine for the first time circadian rhythmicity at the molecular, endocrine and behavioural levels in adult ADHD.

3.2 Methods

Subjects

Adult ADHD patients were recruited from the Adult ADHD clinic at Cefn Coed hospital, Swansea, Wales, (n=14), and age & gender-matched healthy controls (n=30) were recruited from the university staff, hospital staff and a student population. Additionally two of the subjects included as ADHD patients were originally recruited as controls, but were diagnosed with adult ADHD when screened. During the course of the study four of the ADHD patient cohort were undergoing pharmacological treatment for ADHD (dex-amphetamine n=2, methylphenidate n=1, atomoxetine n=1). Only control subjects that were not showing evidence of suffering from a current psychiatric or sleep disorder were included in the study. Participants included in both the ADHD patient cohort and control cohort were recruited across the year. Each participant was assessed using a semi-structured clinical interview supplemented by the Research Version of the Structured Clinical Interview for DSM-IV-TR- Axis I Disorders (SCID-RV), in addition to ADHD questionnaires and psychometric tests; (WHO's Adult ADHD Self Report Scale (ASRS), Conners scales (CAARS-Self-Report Long Version and CAARS-Observer Long Version) and the Wender-Utah Rating Scale (WURS) for retrospective information on childhood ADHD (table 3.1). Chronotype was assessed by completion of the Horne-Ostberg questionnaire.

	ADHD n = 14	Controls n = 30
Age in Years, mean ± SD	31.5 ± 11.7	30.6 ± 12.3
Male, n (%)	9 (64.3%)	15 (50%)
Childhood ADHD symptoms Wurs-K score, mean ± SD	119.5 ± 28.7	42.8 ± 17.3
Adult ADHD Self-Report Scale (ASRS-v1.1), mean ± SD	51.3 ± 13.9	19.3 ± 9.3
<i>CAARS-Self-Report: Long Version</i>		
ADHD Index, mean ± SD	72.5 ± 9.7	42.3 ± 7.9
DSM-IV ADHD symptoms total score, mean ± SD	80.8 ± 12.2	43.5 ± 8.4
DSM-IV ADHD inattentive symptoms score, mean ± SD	82.2 ± 9.1	46.5 ± 8.5
DSM-IV ADHD hyperactive-impulsive symptoms score, mean ± SD	71.7 ± 9.9	41.4 ± 6.8
<i>CAARS-Observer: Long Version</i>		
ADHD Index, mean ± SD	71.9 ± 14.7	44.6 ± 7.6
DSM-IV ADHD symptoms total score, mean ± SD	69.9 ± 13.7	44.2 ± 6.3
DSM-IV ADHD inattentive symptoms score, mean ± SD	71.3 ± 11.4	43.6 ± 5.4
DSM-IV ADHD hyperactive-impulsive symptoms score, mean ± SD	63.5 ± 15.3	45.7 ± 7.0

Table 3.1 Demographic and clinical data

Actigraphy

Subjects wore an ActiWatch Light (Cambridge Neurotech, UK) on their non-dominant wrist for at least 7 days, during which mucosal/salivary samples were collected. Data was transferred for analysis from the ActiWatch to a PC, upon which the Sleep analysis software (Cambridge Neurotech, UK) was installed. Data analysis excluded the first and last days of data collection. Wake times were calculated from actigraphic data by means of the “auto” detection of minimal activity threshold above which an epoch is defined as being during waking time (Sleep analysis software, Cambridge Neurotech). Analysis of actigraphic data was via non parametric circadian rhythm analysis (Van Someren et al, 1999) as well as by 24 hour co-sinor analysis. These methods yielded a number of measures:

Intradaily variability: This is an index of fragmentation of the rhythm, and assesses frequency of transitions between periods of activity and inactivity.

Interdaily stability: This is a measure of the stability of the rhythm between days, and is taken as a measure of the strength of entrainment of the endogenous circadian clock to environmental Zeitgebers.

L5: This is the amount of activity counts that occurs in the least active 5 hours of the 24 hour cycle.

L5o: This is the time of onset of the least active five hour period.

M10: This is the amount of activity in the most active 10 hour period.

M10o: This is the time of onset of the most active 10 hour period.

Relative amplitude: Indicates quantity of activity, derived from the normalized difference between M10 and L5 hour period in an average 24 hour pattern. Values range between 0 and 1, 1 representing the greatest difference between the most and least active phases, and thus the best temporal organisation of the activity cycle.

Amplitude: This is the peak-to-trough difference in terms of activity counts.

Period: This is the period that shows best fit to the data by means of a chi-squared periodogram.

Acrophase: This is the time of the peak of the best fit periodogram.

The ActiWatch also recorded a number of light measures including daily average illumination (lux), maximum illumination (lux) and time spent above the baseline level of light (100 lux). Sleep measures recorded included sleep efficiency, sleep-onset latency, sleep start and end, and total length of sleep.

Clock gene analysis

Buccal samples were collected every four hours over a 24 hours period using foam tipped swabs (Whatman International Ltd, UK) and the material was stored on FTA cards (Whatman International Ltd, UK) at room temperature. RNA was extracted from the FTA cards using the Magmax viral RNA isolation kit (Ambion, UK) and concentrated using carrier RNA and the micro-magnetic beads provided within the kit. The quality and quantity of total RNA isolated was confirmed using the experion RNA HighSens analysis kit (Bio-Rad, UK) and the experion automated electrophoresis system (Bio-Rad, UK). There was no evidence of variations of RNA quality according to time of sampling.

One-step quantitative real-time PCR was performed using the Light Cycler 3.5 (Roche Diagnostics, Germany) with SYBR-Green I dye amplimer detection.

For amplification of the target RNA the following primers were used:

PER2 forward: 5'-GCATCCATATTTCACTGTAAAAGA-3',

PER2 reverse: 5'-AGTAAAAGAATCTGCTCCACTG-3', (Cajochen et al., 2006),
BMAL1 forward: 5'-AAGGATGGCTGTTCAGCACATGA-3',
BMAL1 reverse: 5'-CAAAAATCCATCTGCTGCCCTG-3' (Bjarnason et al., 2001),
GAPDH forward: 5'-GAAGGTGAAGGTCGGAGT-3',
GAPDH reverse: 5'-GAAGATGGTGATGGGATTTTC-3'.

RNA was added to a reaction mixture of final volume 20µl containing one-step RT-PCR kit components (RNA Master SYBR Green I, Roche Diagnostics, UK) with appropriate primers at 0.5µM and 2.5mM MnOAc₂. The following PCR conditions were used. *PER2*: 20 min at 61°C, 30 s at 95°C, followed by 50 cycles of 1 s at 95°C, 5 s at 55°C, 13 s at 72°C and 1 s at 75°C. *BMAL1*: 20 min at 61°C, 30 s at 95°C, followed by 50 cycles of 1 s at 95°C, 5 s at 60°C, 13 s at 72°C and 1 s at 78°C, *GAPDH*: 20 min at 61°C, 30 s at 95°C, followed by 50 cycles of 1 s at 95°C, 5 s at 57°C, 13 s at 72°C and 1 s at 78°C. All samples were amplified in duplicate, and all PCR reactions included duplicate water blank samples as a negative control. Melting curve analysis followed each of these protocols.

Expression levels were normalised to the levels of the *GAPDH* gene and relative mRNA abundance was calculated using the $2^{-\Delta\Delta CT}$ method (e.g. Cajochen et al, 2006).

Melatonin and cortisol analysis.

Saliva samples were collected every four hours over a 24 hours period (at the same time periods as buccal sampling), by chewing on a cotton swab (Salivettes, Bühlmann Laboratories, Schönenbuch Switzerland) and subsequently stored at -20°C prior to analysis. Subjects were asked to collect night time samples under dim illumination. Prior to analysis saliva samples were thawed at room temperature and centrifuged at 2000-3000 x g for 10 minutes to remove particulate material. Both the levels of cortisol and melatonin of the spun saliva samples were assayed in duplicate by ELISA, according to the manufacturer's protocol (IBL international, Germany). The optical density of each well was determined using a microplate spectrophotometer at 450 nm (reference wavelength 600-650 nm). A standard curve of the optical densities against their

corresponding concentrations of the standards supplied within the kit was calculated using a 4 parameter logistics fit, and the concentrations of the samples were subsequently calculated from the standard curve.

PCR Amplification of target DNA in the 3' UTR of the Clock gene

Amplification of the target DNA containing the rs1801260 polymorphic site was performed using PCR (BioRad, UK) with the following primers:

Clock forward: 5'-CCAGCAGTTTCATGAGATGC-3' and

Clock reverse: 5'-GAGGTCATTTTCATAGCTGAGC-3' (Katzenberg et al., 1998, Kissling et al., 2008). The reaction was performed in a final volume of 25µl consisting of the target DNA present in the buccal cell samples, and a reaction mix of dNTPs (Applied Biosystems, UK), 2.5mM MgCl₂ and components supplied within the HotStarTaq DNA polymerase kit (Qiagen, UK). The following PCR protocol was used: 10 min at 95°C, then 35 cycles of 30 s at 94°C, 30 s at 58°C and 30 s at 72°C, followed by 2 min at 72°C. All PCR reactions included water blank samples as a negative control for DNA contamination. The amplicon (221bp) was visualized on a 2% agarose gel stained with SYBRsafe (Invitrogen, UK), following separation at 100V in tris-borate electrophoresis buffer.

Restriction Digest

10µl of the PCR product was digested in a final volume of 20µl with Bsp1286I (New England Biolabs, UK) and reaction buffers at 37°C overnight. The resulting digested samples (unrestricted TT genotype = 221 bp, complete restriction CC genotype = 125 and 96 bp, partial restriction TC genotype = 221, 125 and 96bp fragments) were visualized using electrophoresis as previously described and scored for genotypes. All RFLP assays were run with a positive control (CC genotype), that was amplified by PCR and subsequently the amplicon underwent total restriction upon incubation with the Bsp1286I restriction endonuclease (New England Biolabs, UK) as described above.

Data analysis

Clock gene and hormone data is presented as standardised Z-scores, to allow for the direct inter-variable comparison of amplitudes between genes and hormones measured in different units (Archer et al, 2008). Z-scores were calculated for each participants set of time-course samples. This calculation can be described as the subtraction of the average data across the time-points from each individual time-point value, divided by the standard deviation. The hormone data was Z-scored from the raw data, the clock gene data was Z-scored from GAPDH-normalised data.

Further description of changes in the rhythm of the time-course data (clock gene expression and hormone rhythms) were carried out by measuring the area under the curve. This is a well documented method of estimating ultradian/circadian changes in time-course data (Pruessner et al., 2003). Two methods of calculating the area have been devised and were used: the area under the curve with respect to ground (0, AUC_G) and the area under the curve with respect to increase (the lowest data point, AUC_I), both of which have been derived from the trapezoid formula (Pruessner et al., 2003). These formulas are summarized as:

$$AUC_G = \sum_{i=1}^{n-1} \frac{(m_{(i+1)} + m_i) \cdot t_i}{2}$$

$$AUC_I = AUC_G - m_1 \cdot \sum_{i=1}^{n-1} t_i$$

Where m is measurement, t is the time-interval between two consecutive data points and i is the individual data point and n is the total amount of measures (Pruessner et al., 2003).

Statistical Analysis

The statistical software SPSS (IBM Corporation, USA) installed on a PC was used to carry out group-wise comparisons of actigraphic, sleep and light parameters and AUC measurements by Mann-Whitney U tests, as the majority of the data did not conform to the normal distribution. Correlations between the DSM ADHD index

score and chronometric parameters was by Pearson's product moment correlation, one-tailed to test the hypothesis that increasing clinical scores would be correlated with decreasing robustness of rhythmic parameters. Allele frequencies of the rs1801260 polymorphism were tested for Hardy Weinberg equilibrium and differences between groups using the Chi Square test. Clock gene expression and hormone data was fitted by the method of single co-sinor analysis to determine whether significant circadian rhythms were present, by means of the Chronolab software (Mojon et al., 1992). This involved fitting a curve with a 24 period to the observed data by the least squares method, with the fit deemed significant if the 95% confidence interval for the fitted amplitude did not include zero. $f(t_i) = M + A \cos(\omega t_i + \phi) + \epsilon_i$ was the formula for curve fitting, where $f(t_i)$ was the expression of the factor of interest across time for individual i , M was the MESOR, the time series mean around which expression oscillates, A was the amplitude of the rhythms, ω was the period of the fitted rhythm and was the acrophase of the rhythm and ϵ_i was the error term. The regression fitting also produced an r-squared statistic, which was then used to compute the percentage of variance in an individuals time-series data that was accounted for by the fitted 24hour curve. For between group comparisons of chronometrics derived by this method we used the Bingham test (Bingham et al., 1982), which compared the amplitude, MESOR, acrophase, and amplitude/acrophase pair between groups, with $p < 0.05$ considered significant. Z-scored data was examined, although the data was also analysed by the above methods prior to Z-scoring, with no meaningful differences observed between the two methods.

3.3. Results

3.3.1 Actigraphy and Diurnal Preference

Non-parametric analysis of the actigraphic circadian rhythms revealed no significant difference in the interdaily stability (IS) and intradaily variability (IV) between the control and ADHD groups (table 3.2). Both the amount of activity in the least active five hours of the 24 h cycle, L5, and the amount of activity in the most active ten hour period, M10, were increased in the ADHD cohort, therefore resulting in an increase in the rhythm amplitude in the ADHD group (table 3.2, figures 3.1 and 3.2). There were however, no between groups differences in the relative amplitudes (normalised difference between M10 and L5), the time of M10 and L5 onset (M10o and L5o respectively) or the acrophase of the actigraphic rhythm. Analysis of the period of best fit showed that the ADHD group display significantly shorter period than the controls, as demonstrated by both direct estimation of the period ($P < 0.01$, table 3.2, figure 3.3) and by deviation of the period from 24h (0.17h for controls vs. 0.40h for ADHD, $P < 0.05$, table 3.2). Non-parametric analysis of the sleep parameters measured by actigraphy revealed a significant difference in the actual sleep time and sleep efficiency between the control and ADHD groups ($P < 0.05$ for both, table 3.3). The ADHD group exhibited a shorter duration of sleep ($06:08 \pm 01:22$) in comparison to the control group ($07:11 \pm 00:40$), and reduced sleep efficiency (79.7% for controls vs. 72.14% for ADHD group), although there were no significant differences between the two groups in the other sleep parameters measured and the objectively assessed wake-times (table 3.2).

	Control	ADHD	Control Vs. ADHD
IS	0.579 ± 0.03	0.546 ± 0.03	n.s.
IV	0.785 ± 0.05	0.707 ± 0.05	n.s.
M10	19620 ± 1156	25302 ± 1430	P<0.001
M10o (h)	9.52 ± 0.32	10.80 ± 1.01	n.s.
L5	841 ± 98	1647 ± 295	P<0.001
L5o(h)	2.2 ± 1.1	4.45 ± 1.6	n.s.
Amplitude	18785 ± 1156	23696 ± 1273	P<0.01
Relative amplitude	0.904 ± 0.015	0.879 ± 0.015	n.s.
Period (h)	23.95 ± 0.07	23.76 ± 0.14	P<0.01
Period deviation (h)	0.17 ± 0.15	0.40 ± 0.29	P<0.05
Acrophase (h)	14.62 ± 0.29	14.83 ± 0.66	n.s.
Wake (h)	7.96 ± 0.27	8.61 ± 0.47	n.s.
HO MEQ Score	52.6 ± 1.4	41.5 ± 2.1	P<0.005

Table 3.2. Chronometrics of the actigraphic circadian rhythm, and the Horne-Ostberg morningness/eveningness (HO MEQ) score. IS = Interdaily stability; IV = intradaily variability; M10 = activity counts in the 10 most active hours; M10o = time of onset of the ten most active hours; L5 = activity counts in the five least active hours; L5o = time of onset of the least active five hours; Amp = amplitude of the rhythm in activity counts; Rel. Amp. = Relative amplitude of the circadian rhythm; Period = period of best fit; Acro. = Acrophase (peak phase of rhythm); Wake = actigraphically determined wake time. n.s. = not significant. Between group differences of actigraphic parameters were assessed by non-parametric Mann-Whitney U tests (Control Vs ADHD) and this revealed significant between group differences in M10, L5, amplitude, period, period deviation and HO MEQ score.

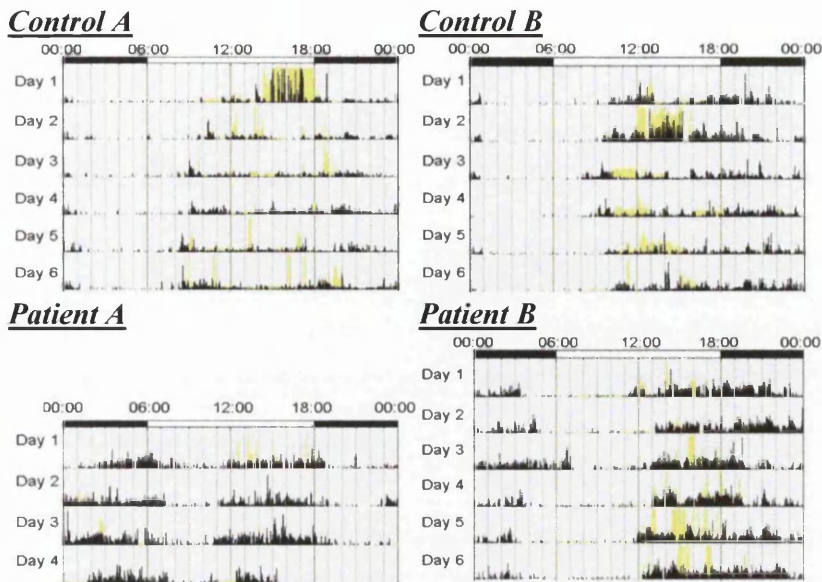

Figure 3.1. Example actograms of the daily activity levels measured by the actiwatch. Patient A exhibits a bimodal activity rhythm over the 24 hour period, whereas patient B exhibits a 4-6 hour delay in the phase of the activity rhythm compared to the controls subjects A and B. Both patients exhibit increased activity during the hours of least activity of the control subjects (12am-6am). (Activity = black, light illumination = yellow).

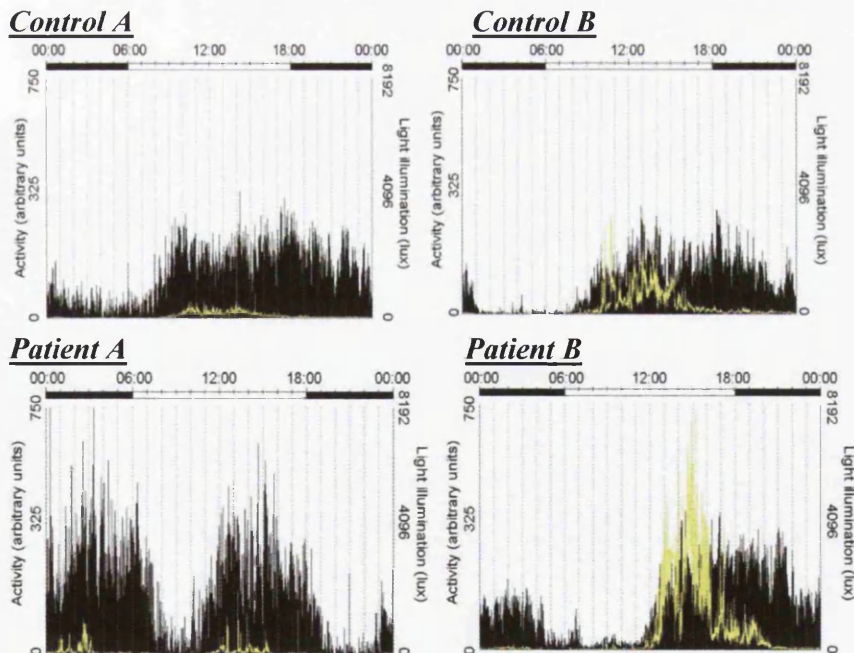
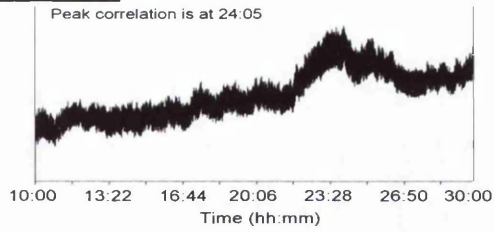
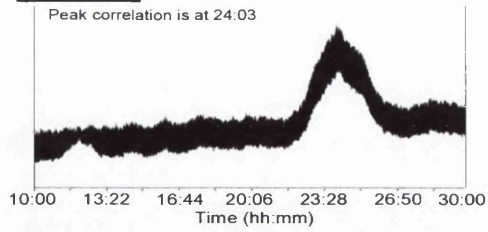

Figure 3.2. Example of average daily activity profiles as measured by the actiwatch. (Activity = black, light illumination = yellow).

Control A



Control B



Patient A

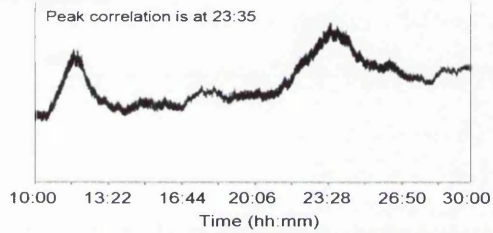

Patient B

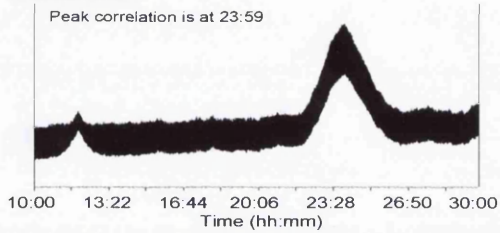

Figure 3.3. Example periodograms of the average period length of the activity rhythm as measured by the actiwatch. Note that the average period length (peak correlation) is greater in the control group than the ADHD group.

	Control	ADHD	Control Vs. ADHD
Bedtime (h)	23:14 ± 00:55	00:34 ± 02:19	n.s
Get up time (h)	07:40 ± 00:56	07:50 ± 02:01	n.s
Time in bed (h)	08:58 ± 00:39	08:27 ± 01:13	n.s
Sleep start (h)	23:43 ± 00:55	01:25 ± 02:29	n.s
Sleep end (h)	07:53 ± 00:53	07:40 ± 01:59	n.s
Assumed sleep time (h)	08:15 ± 00:40	07:26 ± 01:21	n.s
Actual sleep time (h)	07:11 ± 00:40	06:08 ± 01:22	P<0.05
Actual sleep % (%)	87.13 ± 4.21	82.34 ± 8.83	n.s
Actual wake time (h)	01:04 ± 00:22	01:16 ± 00:35	n.s
Actual wake % (%)	12.87 ± 4.21	17.66 ± 8.83	n.s
Wake bouts (#)	40.40 ± 9.05	44.93 ± 13.20	n.s
Sleep bout duration (min)	14:39 ± 16:00	09:11 ± 03:16	n.s
Wake bout duration (min)	01:38 ± 00:30	01:41 ± 00:34	n.s
Sleep efficiency (%)	79.7 ± 7.42	72.14 ± 10.92	P<0.05
Sleep latency (h)	00:27 ± 00:18	00:34 ± 00:20	n.s

Table 3.3. Summary of the actigraphically assessed sleep parameters (means and standard deviations). Time in bed = difference between bed time and get up time; Assumed sleep time = difference between sleep start and sleep end, Actual sleep time = assumed sleep minus periods of wakefulness during the night; Actual sleep % = percentage of sleep in the duration between sleep start and sleep end. Actual wake time = hours of wakefulness during assumed sleep time; Actual wake % = percentage of wakefulness during assumed sleep time; Wake bouts (number of) = number of times participant wakes during sleep; Sleep bout duration = average length of uninterrupted sleep between two consecutive awakenings; Wake bout duration = mean duration of periods of wakefulness; Sleep efficiency = percentage of sleep between bed time and sleep end; Sleep latency = the time it takes from bed time to sleep start. Non-parametric Mann-Whitney U tests revealed significant between group differences in actual sleep time and sleep efficiency. n.s. = not significant.

Levels of light exposure were also examined and whilst there was no overall difference in the average illumination across a 24 hour period, a significant increase in the average illumination in the six hours between midnight and 6am in ADHD subjects compared with controls was observed, which is in accordance with the increase in L5 observed in ADHD (table 3.4).

Group	24 Hours			12am - 6am		
	Average illumination mean \pm SD	Maximum illumination mean \pm SD	Time above 100 lux / minutes, mean \pm SD	Average illumination mean \pm SD	Maximum illumination mean \pm SD	Time above 100 lux / minutes, mean \pm SD
ADHD	251.2 \pm 274.9	12626.0 \pm 9949.9	256.5 \pm 125.6	12.1 \pm 31.4	325.1 \pm 685.9	7.9 \pm 21.8
Controls	301.6 \pm 418.8	11556.0 \pm 7764.7	294.5 \pm 160.6	1.2 \pm 1.7	96.8 \pm 159.4	0.8 \pm 1.2
Control Vs. ADHD	n.s.	n.s.	n.s.	P<0.05	n.s.	n.s.

Table 3.4. Light exposure (lux) as measured by the actiwatches worn by study participants. Average nocturnal light exposure was significantly greater in the ADHD group, $P < 0.05$. n.s. = not significant.

Analysis of the Horne-Ostberg (HO) morningness/eveningness questionnaire data showed that the ADHD subjects scored significantly lower than the controls, indicating a shift to eveningness in ADHD (table 3.5). Further, when subjects were assigned a chronotype according to their HO scores (morning types scoring 59-86, intermediate 42-58 and evening types less than 42), chi-squared analysis revealed a significant difference ($p < 0.05$) between the control and ADHD groups, with 50% of the ADHD being classified as evening oriented, compared to 13% for the controls (table 3.5). Moreover there were significant inverse correlations between the DSM index ADHD scores and the HO score and the actigraphic period ($r = -0.619$ and -0.534 respectively, both $P < 0.005$, figure 3.4A-B). There were also significant correlations between the DSM index ADHD scores and the actigraphic period deviation and the wake-time according to the actigraphic data ($r = 0.570$ $P < 0.005$, $r = 0.372$ $P < 0.05$ respectively, figure 3.4C-D).

Chronotype	Control	ADHD
Morning	8 (26%)	2 (14%)
Intermediate	19 (61%)	5 (36%)
Evening	4 (13%)	7 (50%)
χ^2	7.189	
P	<0.05	

Table 3.5. Chronotype assigned according to the Horne-Ostberg morningness/eveningness questionnaire. Chi-square analysis revealed a significant difference in chronotype between the groups.

A number of significant correlations between the DSM index ADHD score and actigraphically assessed sleep parameters were observed including get up time ($r=0.512$, $P<0.01$), sleep end ($r=0.465$, $P<0.01$) and percentage wake time ($r=0.352$, $P<0.05$) (figures 3.4E, 3.4H and 3.4K respectively). Inverse correlations were demonstrated between the DSM index ADHD score and bed time ($r=-0.443$, $P<0.01$), sleep start ($r=-0.339$, $P<0.05$), actual sleep duration ($r=-0.365$, $P<0.05$), percentage sleep duration ($r=-0.352$, $P<0.05$) and sleep efficiency ($r=-0.379$, $P<0.05$) (figures 3.4F- G, 3.4J-M respectively).

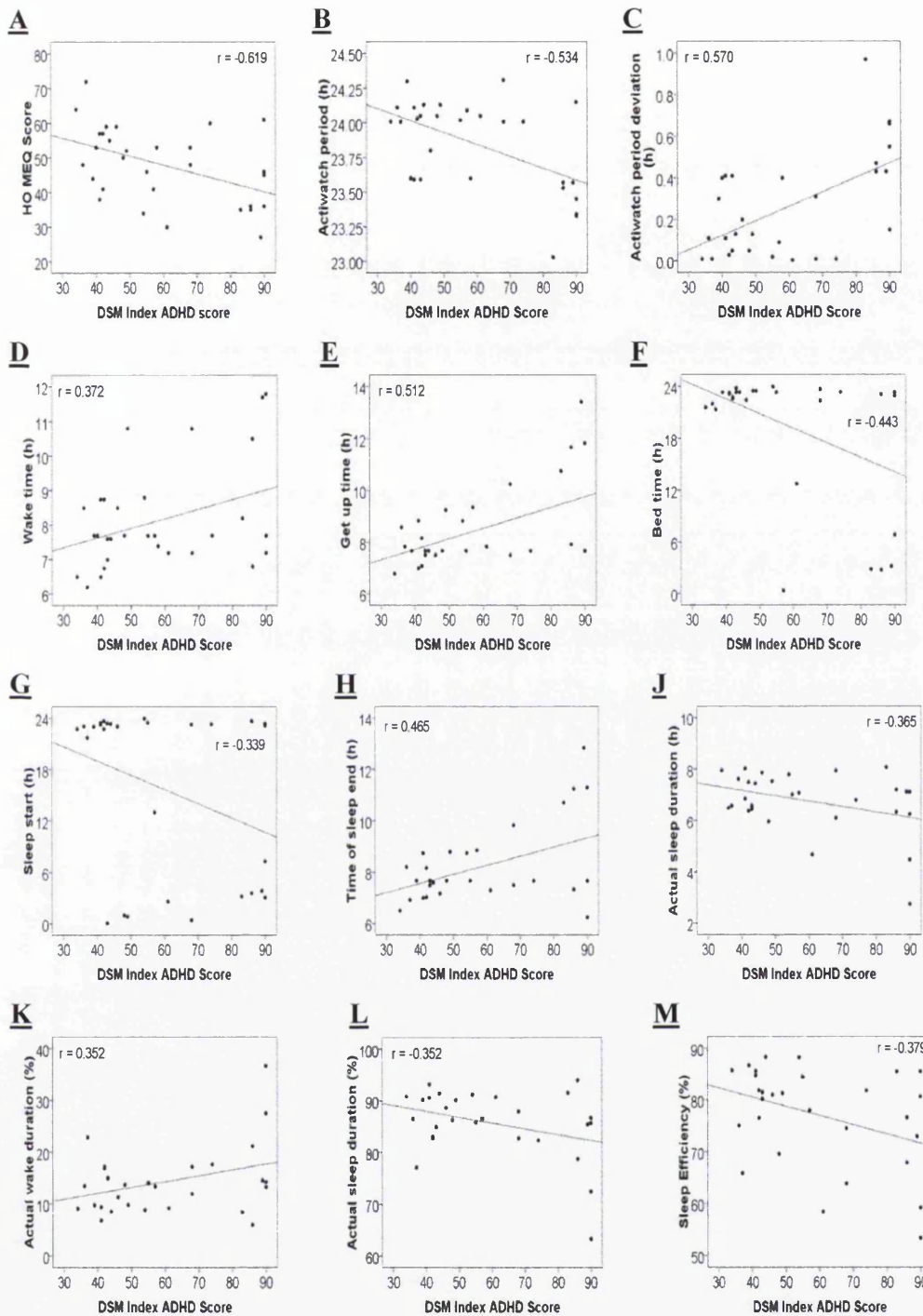

Figure 3.4. Significant correlations between the DSM index ADHD score and activity and sleep parameters. HO MEQ score = Horne-Ostberg morningness/eveningness score; Wake time = actigraphically determined wake time; Period = duration of 1 full cycle of the rest-activity rhythm; Period deviation = difference in period length from 24 hours; Actual sleep duration = assumed sleep minus periods of wakefulness during the night; Actual sleep duration % = percentage

of sleep between sleep start and sleep end; Actual wake duration % = percentage of wakefulness during assumed sleep time; Sleep efficiency = percentage of sleep between bed time and sleep end. Increasing DSM index ADHD score is indicative of increasing ADHD symptom severity.

3.3.2 Clock gene and hormone rhythms

BMAL1 exhibited rhythmic expression in the oral mucosa in the control group, as judged by co-sinor analysis, with the peak of the rhythm present ~13 hours after waking (figure 3.5A and 3.5D, table 3.6). This rhythmicity was lost in the ADHD group, which did not display significant circadian fluctuation in *BMAL1* expression levels (figure 3.5B and 3.5D, table 3.6). The two groups were compared by means of the Bingham test, and the amplitude and amplitude/acrophase relationship was found to be significantly different between the control and ADHD groups ($P < 0.01$ for amplitude, $P < 0.05$ for amplitude/acrophase) although there was no difference for MESOR, acrophase (figure 3.5C and 3.5D, table 3.6) or the area under the curve of the *BMAL1* expression profile (figure 3.5E and D).

	<i>BMAL1</i>		<i>PER2</i>		Melatonin		Cortisol	
	Control	ADHD	Control	ADHD	Control	ADHD	Control	ADHD
Percentage Rhythm (%)	56.8	33.9	63	53	63	53	60	50
P	0.002	0.617	<0.001	0.11	<0.001	0.11	<0.001	0.003
Mesor (a.u)	-0.03 ±0.0	-0.03 ±0.03	0.06 ± 0.4	-0.01 ±0.2	0.06 ± 0.4	-0.01 ±0.2	0.01 ±0.03	0.03 ±0.04
Amplitude (a.u)	0.61	0.10	0.62	0.25	0.62	0.25	0.87	0.65
C.I. Amplitude (a.u)	0.3, 0.9	0,0	0.4, 4.5	0, 0	0.4, 4.5	0, 0	0.7, 1.0	0.3, 1.0
Acrophase (h)	13.26	12.88	18.9	19	18.9	19	1.37	3.37
C.I. Acrophase (a.u)	11.5, 15.0	0,0	17.5, 21.3	0,0	17.5, 21.3	0,0	0.73, 2.0	1.53, 5.27

Table 3.6. Chronometrics of the *BMAL1*, *PER2*, melatonin and cortisol rhythms, as assessed by co-sinor analysis. The profiles of *BMAL1* and *PER2* expression and melatonin and cortisol secretion of the control group were significantly rhythmic. The profile of cortisol secretion of the ADHD group was significantly rhythmic also. a.u. = arbitrary units.

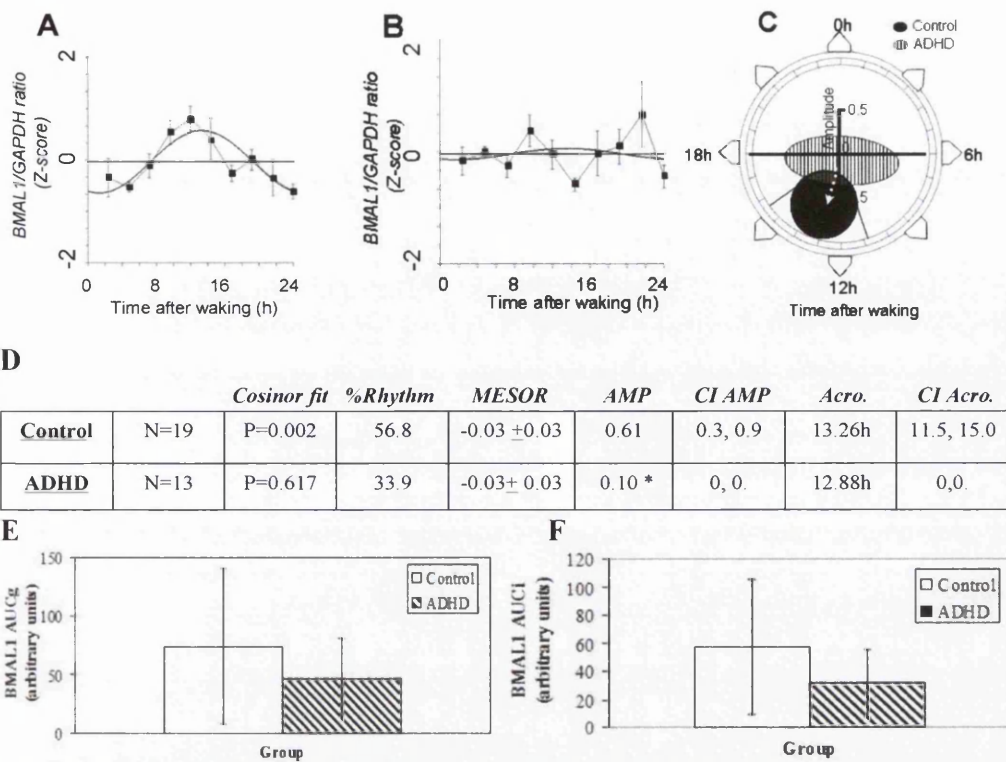

Figure 3.5. Analysis of the rhythmic expression of *BMAL1*. **(A)** Chronogram of the *BMAL1* profile of the control group. **(B)** Chronogram of the *BMAL1* profile of the ADHD group. Fitted dark line = co-sine wave of best fit with a 24 hour period. Horizontal line = MESOR. **(C)** Polargram of the phase/amplitude relationship for *BMAL1* expression for the control (black ellipse) and ADHD (hatched ellipse) groups. Length of the dotted white vector indicates amplitude of circadian rhythm and the orientation of this vector represents the acrophase for the control group. 95% confidence interval for the combined amplitude and acrophase are represented by elliptical areas around the vector tips, indicated by lightly dashed line. The error ellipse for the ADHD group covers the zero point of amplitude, indicating a non-significant circadian fit for the observed data, whilst the error ellipse of the control group does not overlap the zero point, indicating a significant co-sinor fit for the data on a 24h timebase. **(D)** Chronometrics of the *BMAL1* expression profile for both groups. % rhythm = variance in the population data that is explained by regression with the 24h co-sine wave of best fit. AMP=amplitude of the rhythm, CI AMP = 95% confidence interval for the amplitude, Acro. = time of the peak of the rhythm, CI Acro. = 95% confidence interval for the amplitude. * = Significant group-wise difference assessed by the Bingham test ($P < 0.05$). Area under the curve of the *BMAL1* profile calculated using the AUC_G method **(E)** and the AUC_I method **(F)**.

Expression of the clock gene *PER2* was also analysed in the same samples. Rhythmic circadian expression of *PER2* was again demonstrated by the control group, with a peak of the rhythm occurring ~12hours after waking (Figure 3.6A and 3.6D, table 3.6). The ADHD group did not display a significant circadian rhythm in *PER2* expression ($P=0.83$ for the 24h co-sine fit; figure 3.6B and 3.6D, table 3.6), although the Bingham test for between groups comparisons of the chronometrics did not reveal any significant differences (figure 3.6C and 3.6D, table 3.6), and there was no significant between group differences in the area under the curve measured by both the AUC_G and AUC_I methods (Figures 3.6E and F).

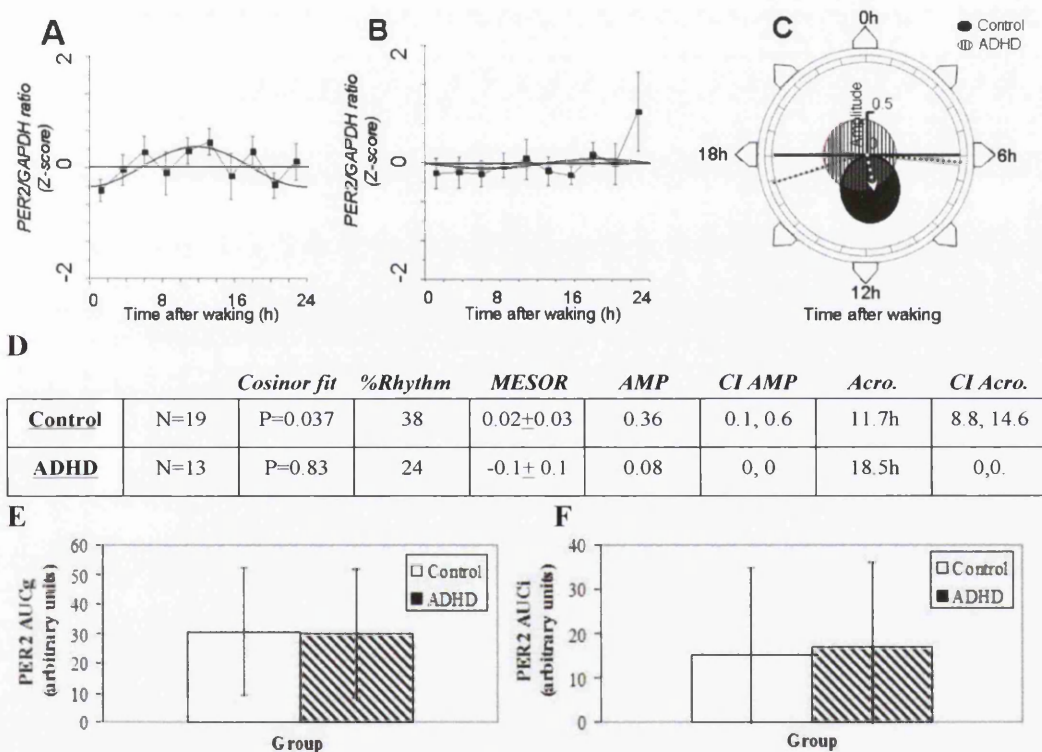

Figure 3.6. Analysis of the rhythmic expression of *PER2*. **(A)** Chronogram of the *PER2* profile of the control group and **(B)** chronogram of the *PER2* profile of the ADHD group. The fitted dark line represents the co-sine wave of best fit with a 24 hour period. The horizontal line represents the MESOR. **(C)** Polargram of the phase/amplitude relationship for *PER2* expression of the control (black ellipse) and ADHD (hatched ellipse) groups. Length of the dotted white vector indicates amplitude of circadian rhythm and the orientation of this vector represents the acrophase for the control group. Note that the error ellipse for the ADHD group covers the zero point of amplitude, indicating a non-significant circadian fit for the

observed data. **(D)** Table summarising the chronometrics of the rhythmic expression of *PER2*. Abbreviations are as described in figure 3.5. Average area under the curve of the *PER2* profile calculated using the AUC_G method **(E)** and the AUC_I method **(F)**.

As expected, melatonin was strongly rhythmic in the control group, with a peak of secretion occurring 19 hours after waking (approximately 3am; figure 3.7A and D, table 3.6). The ADHD group displayed a rhythm that appeared to be broadly similar, with a peak in secretion in the early morning, but with dampened amplitude, and thus the rhythm was not deemed significant by co-sinor analysis (figure 3.7 B and D, table 3.6). However, between groups comparisons by the Bingham test did not reveal significant differences in any of the parameters (figure 3.7C, table 3.6) and there was no significant between group differences in the area under the curve measured by both the AUC_G and AUC_I methods (figures 3.7E and F).

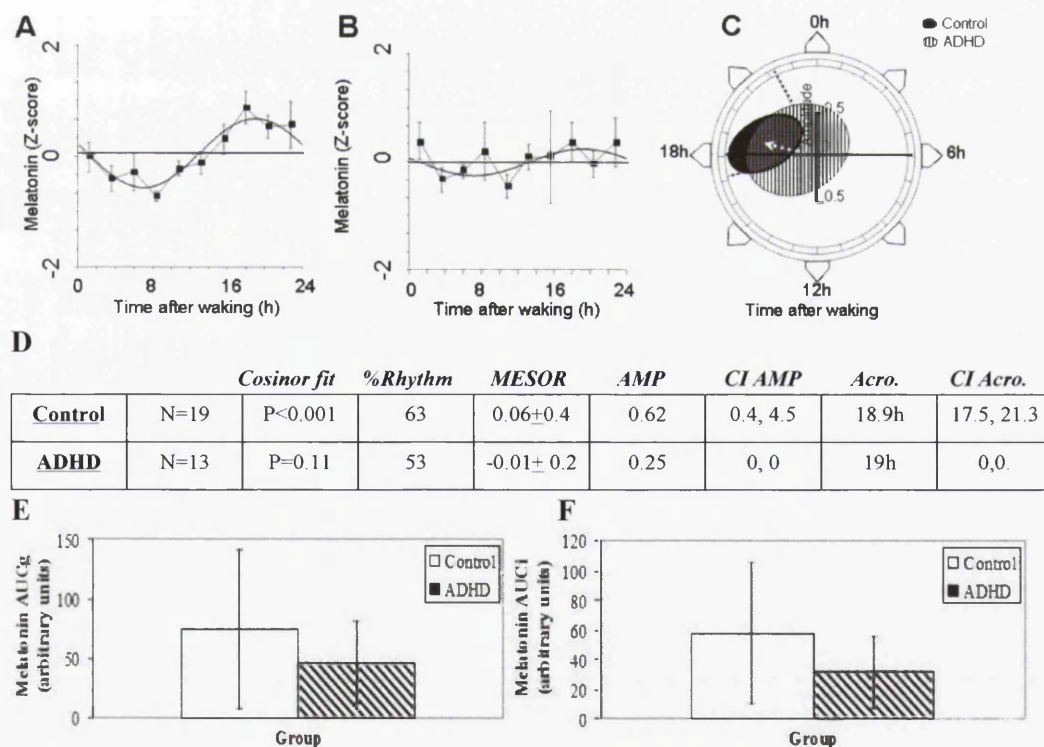

Figure 3.7. Analysis of the rhythmic salivary melatonin profile. **(A)** Chronogram of the melatonin profile of the control group and **(B)** chronogram of the melatonin profile of the ADHD group. The fitted dark line represents the co-sine wave of best fit with a 24 hour period. The horizontal line represents the MESOR. **(C)** Polargram

of the phase/amplitude relationship for melatonin in controls (black ellipse) and ADHD subjects (hatched ellipse). Length of the dotted white vector indicates amplitude of circadian rhythm and the orientation of this vector represents the acrophase for the control group. Note that the error ellipse for the ADHD group covers the zero point of amplitude, indicating a non-significant circadian fit for the observed data. **(D)** Table summarising the chronometrics of the melatonin profile for both groups. Abbreviations are as for figure 3.5. Average area under the curve of the melatonin profile calculated using the AUC_G method **(E)** and the AUC_I method **(F)**.

When salivary cortisol was examined, again as expected the control group showed a robust circadian rhythm with a peak in expression approximately 1 hour after waking (figure 3.8A, table 3.6). The ADHD group also exhibited rhythmic salivary cortisol, although in this group the peak of secretion was phase-delayed relative to wake time and occurred \sim 3hours after waking (figures 3.8B-D, table 3.6). This difference in acrophase was found to be significant by the Bingham test, as was the amplitude/acrophase relationship ($P < 0.05$ for both; figure 3.8C, table 3.6) and the area under the curve of the cortisol profile, which was significantly elevated in ADHD ($P < 0.05$ when measured using both the AUC_G and AUC_I methods, figures 3.8E-F). It therefore appeared that the rhythm in salivary cortisol was present in the ADHD group, although it was significantly phase-delayed, and cortisol levels were increased.

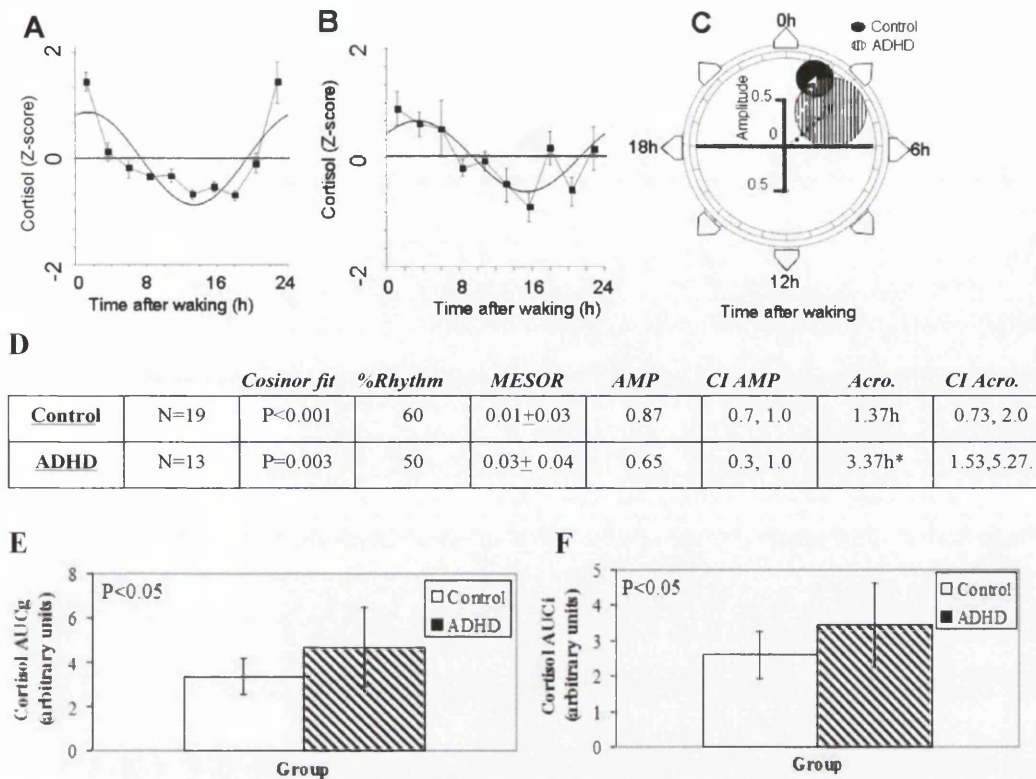

Figure 3.8. Analysis of the rhythmic salivary cortisol profile. **(A)** Chronogram of the cortisol profile of the control group and **(B)** chronogram of the cortisol profile of the ADHD group. The fitted dark line represents the co-sine wave of best fit with a 24 hour period. The horizontal line represents the MESOR. **(C)** Polargram of the phase/amplitude relationship for cortisol in controls (black ellipse) and ADHD subjects (hatched ellipse). Length of the dotted white vector indicates amplitude of circadian rhythm and the orientation of this vector represents the acrophase for the control group, whilst the black dotted vector represent that for the ADHD group. The rhythms in both groups were significant, but note the phase-delay of the cortisol profile in ADHD subjects compared to controls. **(D)** Table summarising the chronometrics of the salivary cortisol profile for both groups. Abbreviations are as for figure 3.5. *= Significant group-wise difference assessed by the Bingham test ($P<0.05$). Average area under the curve of the cortisol profile calculated using the AUC_G method **(E)** and using the AUC_I method **(F)**.

Correlations were examined between the DSM-IV-index ADHD score for each subject with a number of chronometrics from the individual profiles for *BMAL1*, *PER2*, melatonin and cortisol (the amplitude of the individual rhythms, the percentage of variance explained by the fitted 24h co-sine wave and the acrophase).

The hypothesis was that increasing DSM-IV ADHD scores would be correlated with weakening of rhythmic measures (percentage rhythm and amplitude). By this method a significant inverse correlation was uncovered between DSM-IV ADHD score and *BMAL1* amplitude ($r=-0.331$, $P<0.05$, figure 3.9A) *BMAL1* percentage rhythm ($r= -0.344$, $P<0.05$, figure 3.9B), *PER2* amplitude ($r=-0.314$, $P<0.05$, figure 3.9C) and the percentage of variance explained by the 24h co-sine wave for cortisol ($r=-0.444$, $P<0.01$, figure 3.9D). No significant correlations were uncovered between the DSM-index ADHD score and the chronometrics of the melatonin profile.

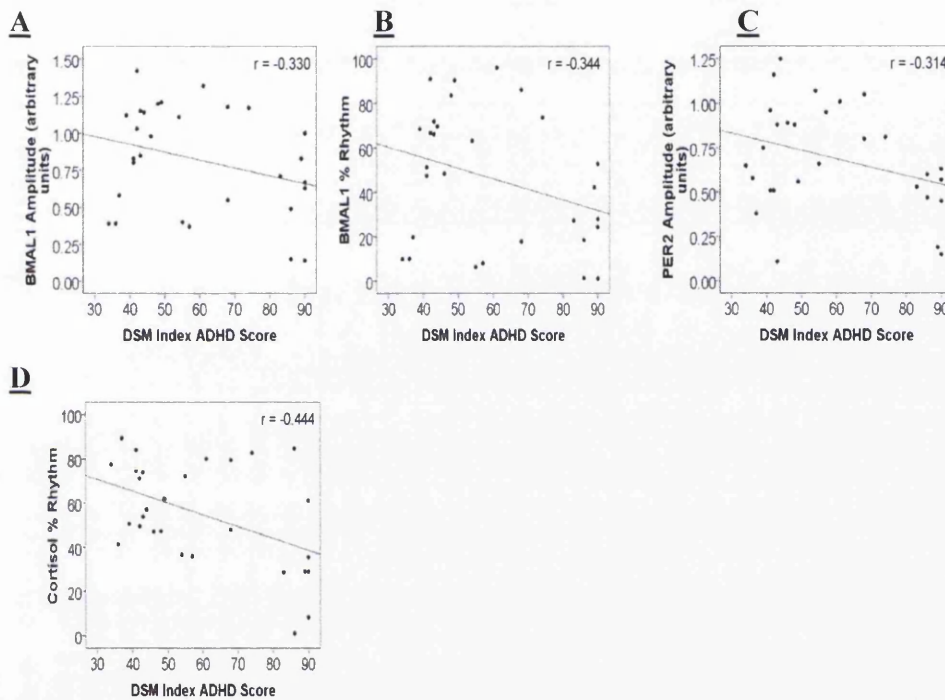

Figure 3.9. Significant correlations between the DSM index ADHD score and the chronometrics of the *BMAL1*, *PER2* and cortisol profiles. Increasing ADHD score is indicative of increasing ADHD symptom severity.

Correlations between the actigraphic measures and the chronometrics of the *BMAL1*, *PER2*, melatonin and cortisol profiles were also examined. Inverse correlations between *BMAL1* amplitude and both M10 ($r=-0.371$, $P<0.05$, figure 3.10A) and M10o were observed ($r=-0.383$, $P<0.05$, figure 3.10B). *BMAL1* acrophase correlated with the period ($r=0.402$, $P<0.05$, figure 3.10C) and relative amplitude of the actigraphic rhythm ($r=0.492$, $P<0.01$, figure 3.10D). Whereas there was an inverse relationship of *BMAL1* acrophase with M10o ($r=-0.515$, $P<0.01$, figure 3.10E) with

L5 ($r=-0.527$, $P<0.01$, figure 3.10F) and with actigraphic period deviation ($r=-0.417$, $P<0.05$, figure 3.10G). A significant correlation between the actigraphic period and % *PER2* rhythm ($r=0.489$, $P<0.01$, figure 3.10H) and *PER2* amplitude ($r=0.535$, $P<0.01$, figure 3.10J), and an inverse correlation between the actigraphic period deviation and % *PER2* rhythm ($r=-0.451$, $P<0.01$, figure 3.10K) and *PER2* amplitude ($r=-0.490$, $P<0.01$, figure 3.10L) were demonstrated.

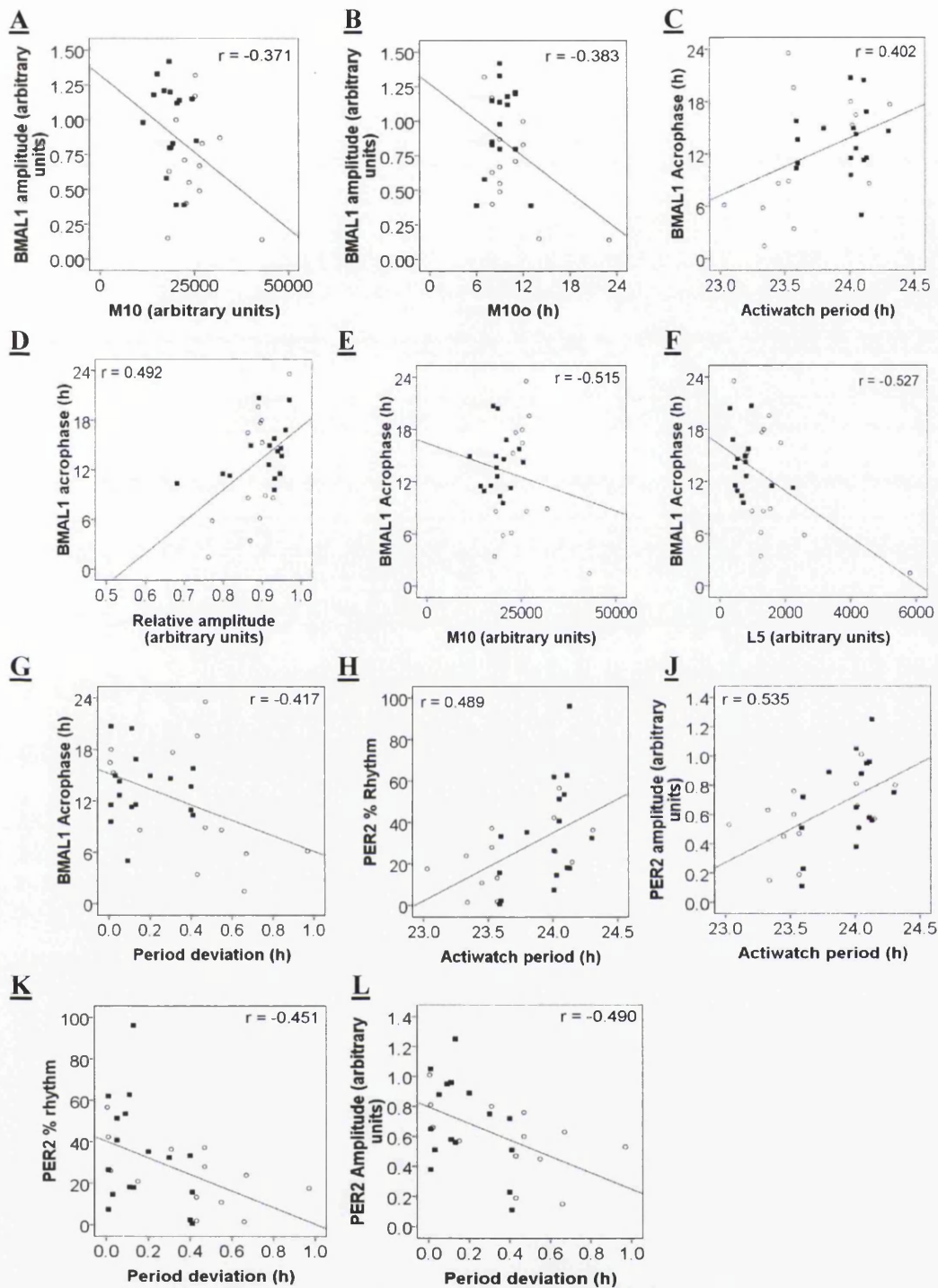

Figure 3.10. Significant correlations between the parameters of the behavioural and the molecular rhythms. M10 = activity counts in the 10 most active hours; M10o = time of onset of the 10 most active hours; L5 = activity counts in the 5 least active hours; Period = duration of 1 full cycle of the rest-activity rhythm; Period deviation = difference in period length from 24 hours; Relative amplitude = difference between L5 and M10; (Black filled squares = control, clear circles = ADHD).

A significant inverse relationship of cortisol % rhythm with actigraphic period deviation ($r=-0.408$, $P<0.05$, figure 3.11A) and with actigraphic acrophase ($r=-0.440$, $P<0.01$, figure 3.11B) was observed. There was a significant correlation of cortisol acrophase with a number of actigraphic measures including with L5 ($r=0.507$, $P<0.01$, figure 3.11C), L5o ($r=0.427$, $P<0.05$, figure 3.11D), M10 ($r=0.498$, $P<0.01$, figure 3.11E), M10o ($r=0.545$, $P<0.01$, figure 3.11F) and amplitude ($r=0.460$, $P<0.05$, figure 3.11G). There was also an inverse correlation of cortisol acrophase with the acrophase of the actigraphic rhythm ($r=-0.389$, $P<0.05$, figure 3.11H).

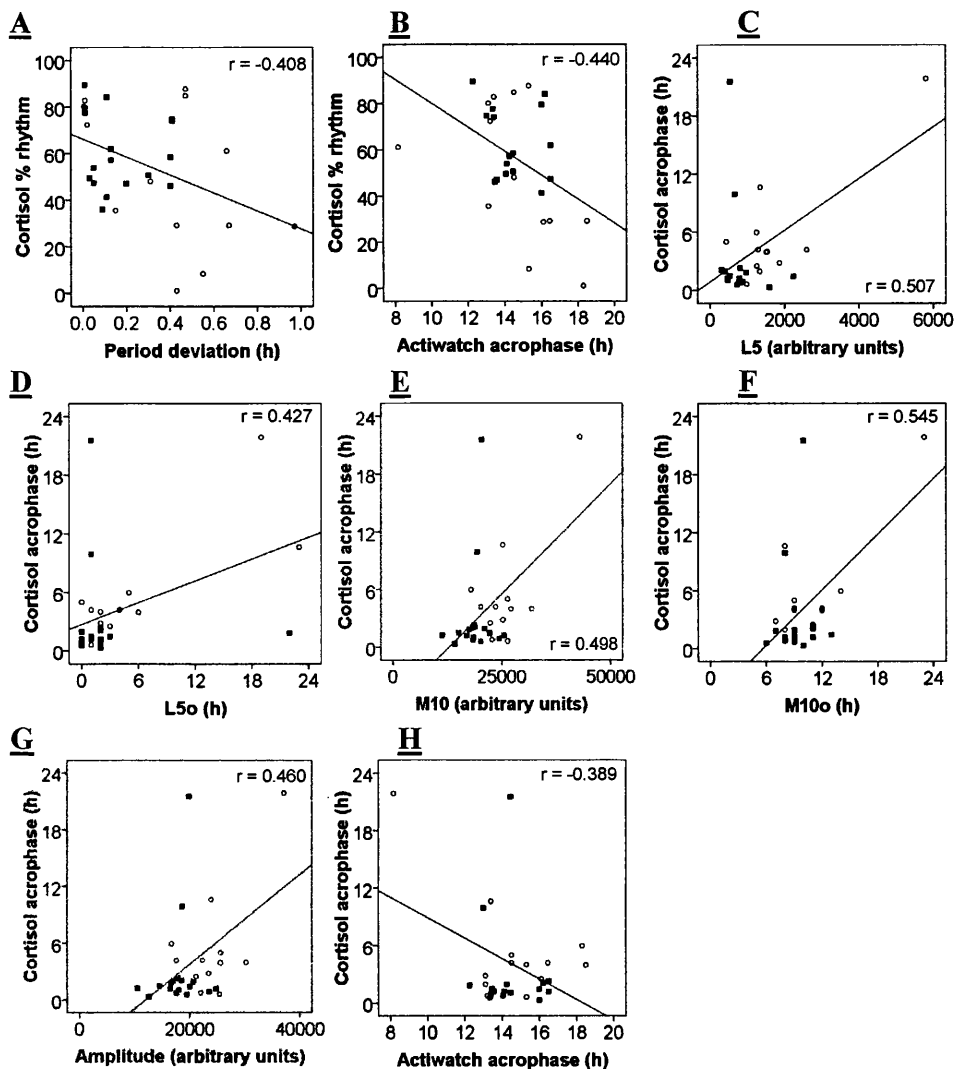

Figure 3.11. Significant correlations between the actigraphic circadian rhythm measures and the chronometrics of the salivary cortisol rhythm. M10 = activity counts in the 10 most active hours; M10o = time of onset of the ten most active hours; L5 = activity counts in the five least active hours; L5o = time of onset of the least active five hours; Amplitude = peak amount of activity; Acrophase = peak phase of rhythm; Period deviation = difference in period length from 24 hours (Black filled squares = control, clear circles = ADHD).

A number of significant correlations were demonstrated between the actigraphically assessed sleep parameters and the chronometrics of the *BMAL1*, *PER2*, melatonin and cortisol profiles. *BMAL1* acrophase significantly correlated with sleep bout duration ($r=431$, $P<0.05$, figure 3.12A) and with actual % sleep ($r=413$, $P<0.05$, figure 3.12B). Then in turn, a significant inverse correlation between *BMAL1*

acrophase and actual % wake ($r=-0.413$, $P<0.05$, figure 3.12C) was observed. There were significant correlations between sleep bout duration and both *PER2* % rhythm ($r=0.428$, $P<0.05$, figure 3.12D) and *PER2* amplitude ($r=0.451$, $P<0.05$, figure 3.12E). An inverse correlation between get up time and *PER2* amplitude ($r=-0.367$, $P<0.05$, figure 3.12F) was demonstrated.

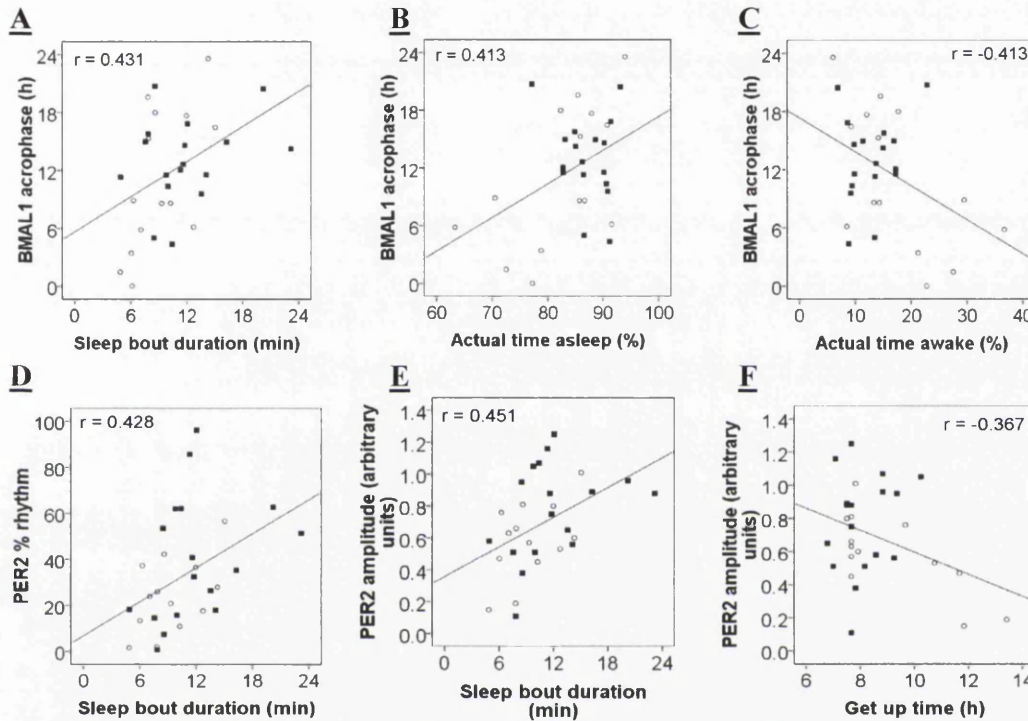

Figure 3.12. Significant correlations between the actigraphically assessed sleep parameters and the chronometrics of circadian clock gene expression. Sleep bout duration = average length of uninterrupted sleep between two consecutive awakenings; Actual time asleep % = percentage of sleep between sleep start and sleep end; Actual time awake % = percentage of wakefulness during assumed sleep time (Black filled squares = control, clear circles = ADHD).

Melatonin % rhythm significantly correlated with the time spent in bed ($r=0.384$, $P<0.05$, figure 3.13A) and with assumed sleep duration ($r=0.394$, $P<0.05$, figure 3.13B). The amplitude of the melatonin rhythm also significantly correlated with both assumed sleep and actual sleep ($r=0.417$, $P<0.05$ and $r=0.441$, $P<0.01$ respectively, figures 3.13C and 3.13D). There was a significant correlation of melatonin acrophase with actual sleep ($r=0.362$, $P<0.05$, figure 3.13E) and with actual % sleep ($r=0.404$, $P<0.05$, figure 3.13F) and a significant inverse relationship

between actual % wake duration and melatonin acrophase ($r=-0.404$, $P<0.05$, figure 3.13G).

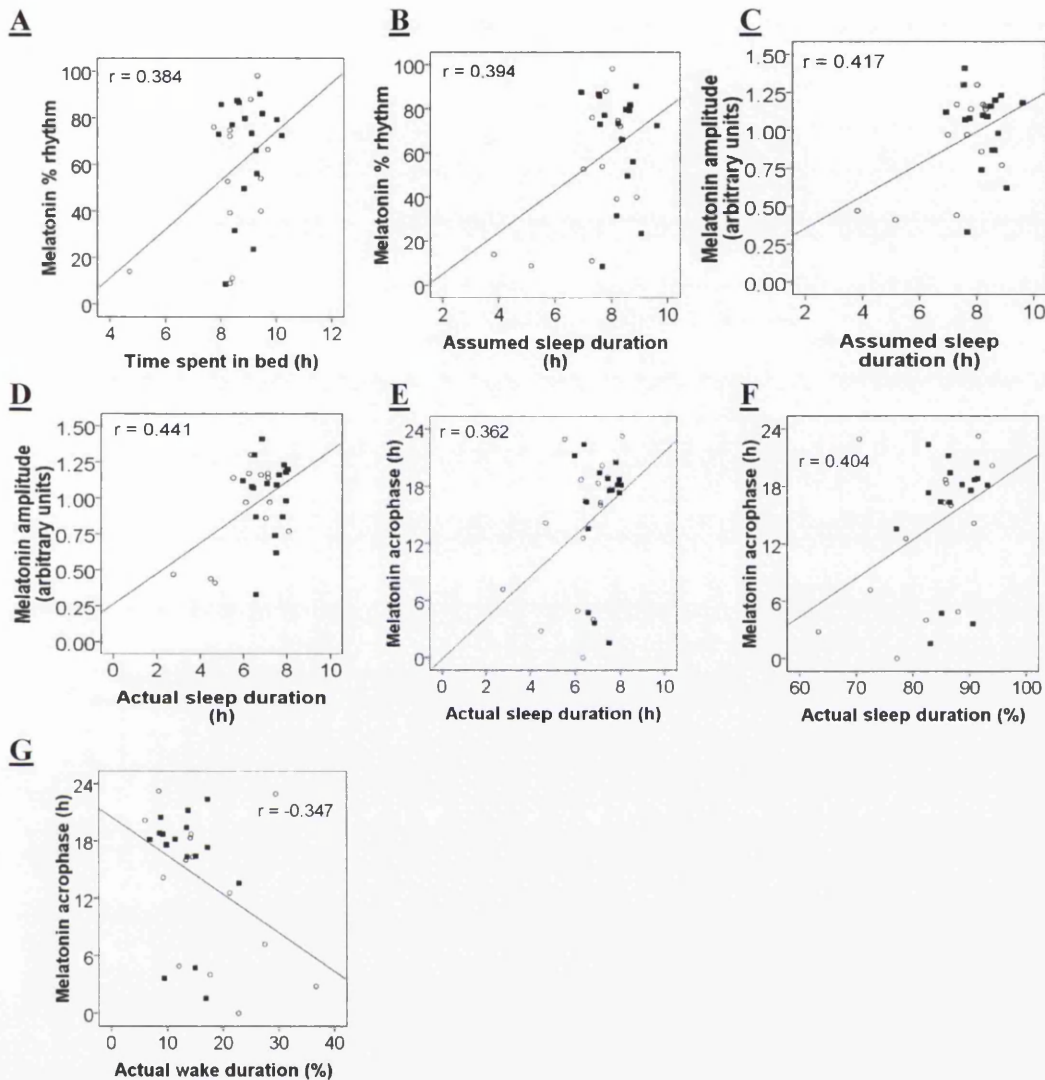

Figure 3.13. Significant correlations between sleep parameters and chronometrics of the salivary melatonin rhythm. Time spent in bed = difference between get up time and bed time; Assumed sleep duration = difference between sleep end and sleep start, Actual sleep duration = assumed sleep minus periods of wakefulness during the night; Actual sleep duration % = percentage of sleep between sleep start and sleep end; Actual wake duration % = percentage of wakefulness during assumed sleep time (Black filled squares = control, clear circles = ADHD).

Cortisol % rhythm significantly correlated with bed time ($r=0.419$, $P<0.05$, figure 3.14A), and an inverse correlation of time of sleep end with cortisol % rhythm was observed ($r=-0.394$, $P<0.05$, figure 3.14B). Significant inverse correlations between cortisol acrophase and assumed sleep ($r=-0.456$, $P<0.01$, figure 3.14C) actual sleep ($r=-0.404$, $P<0.05$, figure 3.14D) and time spent in bed ($r=-0.543$, $P<0.01$, figure 3.14E) were also demonstrated. A significant correlation was shown between get up time and the area under the cortisol curve, AUC_G , ($r=0.339$, $P<0.05$, figure 3.14F), whereas time of sleep start was inversely correlated with both cortisol AUC_G ($r=-0.446$, $P<0.01$, figure 3.14G) and cortisol AUC_I ($r=-0.589$, $P<0.01$, figure 3.14H). Cortisol AUC_I was also inversely correlated with actual sleep ($r=-0.412$, $P<0.05$, figure 3.14J). There was an inverse relationship between cortisol AUC_I and sleep efficiency ($r=-0.468$, $P<0.01$, figure 3.14K).

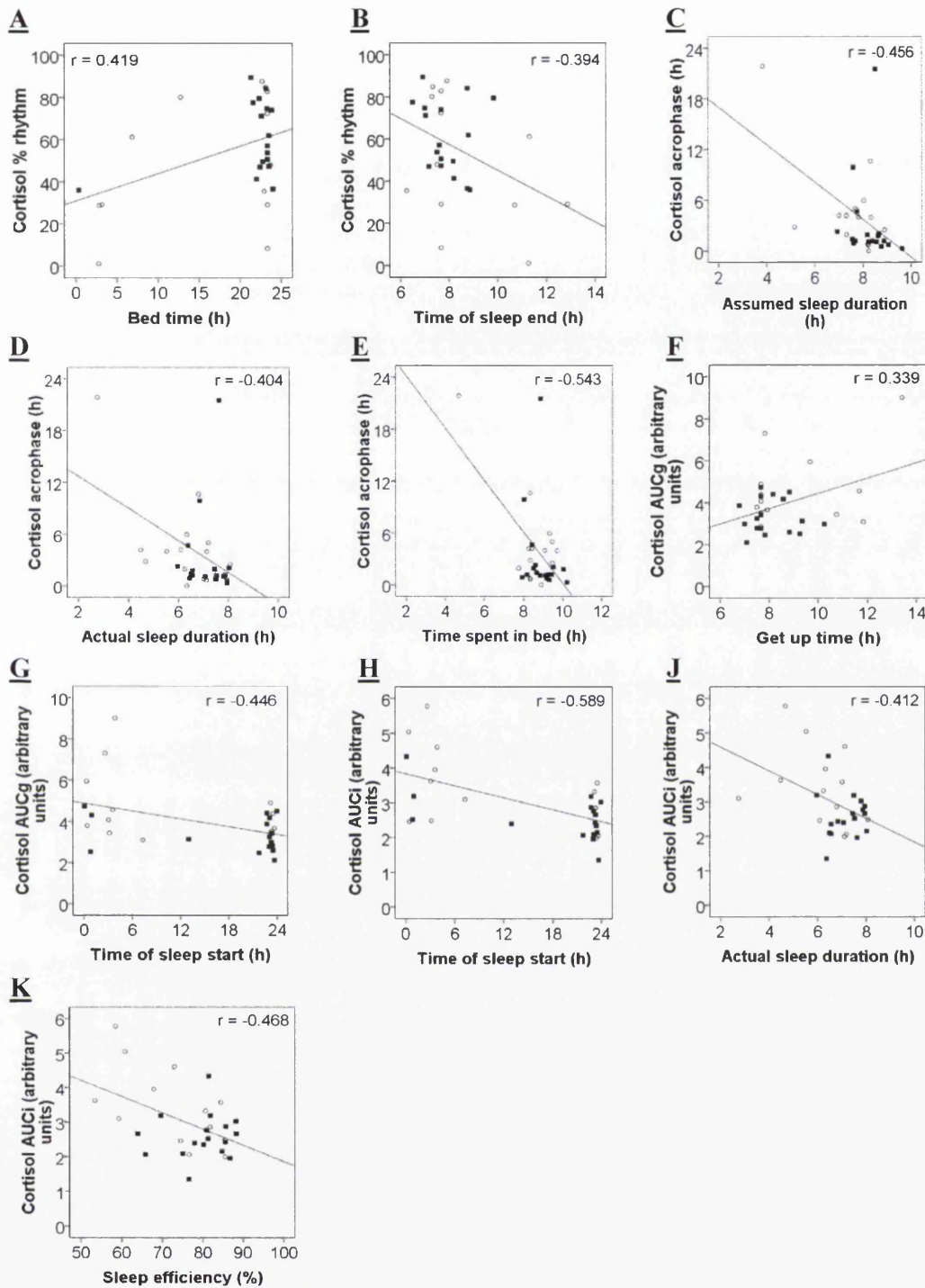

Figure 3.14. Significant correlations between the actigraphically assessed sleep parameters and the chronometrics of the salivary cortisol rhythm. Time spent in bed = difference between get up time and bed time; Assumed sleep duration = difference between sleep end and sleep start, Actual sleep duration = assumed sleep minus periods of wakefulness during the night; Cortisol AUC_G = area under the curve of the cortisol profile calculated with respect to ground; Cortisol AUC_I = area under the

curve of the cortisol profile calculated with respect to increase (Black filled squares = control, clear circles = ADHD).

3.3.3 rs1801260 polymorphism in CLOCK

Chi-square analysis revealed that there were no significant genotype differences of the rs1801260 polymorphism between groups (table 3.7). However, when the relationship between genotype and the chronometrics of the circadian rhythms were examined by ANOVA, there was a significant main effect of genotype upon *BMAL1* amplitude (df=2, $F=4.620$, $P<0.05$), cortisol amplitude (df=2, $F=5.994$, $P<0.01$) and % rhythm of cortisol (df=2, $F=3.481$, $P<0.05$).

	Control	ADHD
TT	12 (63.5%)	4 (30.8%)
TC	7 (36.8%)	8 (61.5%)
CC	0 (0)	1 (7.7%)
T allele	31 (81.6%)	16 (61.5)
C allele	7 (18.4%)	10 (38.5)
χ^2	3.18	
P	0.07	

Table 3.7. Genotype and allele frequencies (%) of the CLOCK rs1801260 polymorphism of the adult ADHD patient and control groups. Chi-squared analysis revealed no significant difference in genotype frequencies between the groups.

3.4 Discussion

The main findings of this study demonstrate fundamental changes in a number of circadian parameters of behavioural, endocrine and molecular rhythms in adult ADHD.

3.4.1 Actigraphy & diurnal preference

Actigraphic analysis demonstrated significantly greater levels of activity during the 5 least active hours and the 10 most active hours were associated with adult ADHD, and significantly increased amplitude of the activity rhythm was associated with adult ADHD. These measures therefore demonstrate hyperactivity of the ADHD patients across the circadian cycle. Boonstra et al (2007) reported increases in M10 in adult ADHD, but not in L5, although the same study does indicate diminished bouts of prolonged nocturnal sleep in ADHD, and that methylphenidate treatment did not alter either L5 or M10, but did alter the onset of L5. Conversely, it has been reported in childhood ADHD that methylphenidate treatment was associated with an increase in nocturnal activity (Ironside et al., 2010). Boonstra et al (2007) did not observe significant differences in adult ADHD in IS, IV or RA, similar to the present results. However in a further study, Van Veen et al., (2010), reported that IV, but not IS, was altered in adult ADHD, and that when adults with ADHD were subdivided according to whether sleep-onset insomnia was present or not, there was a strengthening of the rhythm, as measured by IS, in those with ADHD, but without sleep-onset insomnia, compared to healthy controls. A significant deviation of the period of the activity rhythm away from 24 hours in the ADHD group was observed in the present study, although there was not a significant difference in the time of the acrophase. These results may indicate a measure of altered entrainment to external Zeitgebers in ADHD, which has also been proposed as an explanation for the significant phase-delay of the dim-light melatonin onset in adult ADHD (Van Veen et al., 2010). This is further supported by the shift towards eveningness associated with adult ADHD measured by the Horne-Ostberg morningness/eveningness questionnaire, a finding that is in agreement with a previous study (Rybak et al., 2007). A strong positive correlation was also observed between the DSM index ADHD score and the deviation of the period from 24 hours and an inverse

relationship between the DSM-IV-ADHD score and the period length, therefore suggesting that the period of the activity rhythm would shorten with the severity of the disorder.

The average illumination during the hours of midnight to 6am was significantly increased in the ADHD group in comparison to the control group, which is most probably due to the use of artificial lighting. Along with the observed increase in L5 also associated with adult ADHD, this observation reflects increased activity during the normal hours of sleep. Furthermore, actigraphic analysis revealed that a reduction in both the duration of actual sleep and sleep efficiency were associated with adult ADHD. Previous studies have reported shorter bouts of uninterrupted sleep in adult ADHD (Boonstra et al., 2007, Van Veen et al., 2010), although in both studies actual sleep duration was unaltered in ADHD. The association of reduced sleep efficiency in adult ADHD reported in the present study is in agreement with previous findings by both actigraphy (Boonstra et al., 2007, Van Veen et al., 2010) and polysomnography studies (Sobanski et al., 2008).

The present findings of positive correlations of the DSM index ADHD score with get up time and with sleep end were in accordance with the shift to eveningness observed in the ADHD cohort of the present study. Sleep efficiency, percentage sleep and actual sleep duration were inversely correlated with the DSM index ADHD score, whilst time to go to bed, time of sleep start and percentage duration of time awake were positively correlated with the DSM index ADHD score, thus indicating that as the disorder becomes more severe the quality and quantity of sleep is reduced. This finding is supported by the observation that sleep problems are commonly reported in adult ADHD (Sobanski et al., 2008) and furthermore that some of the key symptoms of ADHD; for example inattention and restlessness, are also common symptoms of sleep deprivation (Corkum et al., 1998). However, it is worth sounding a note of caution in the interpretation of any actigraphic data, in that it assesses the gross rhythm in motor output, and does not delineate between endogenous circadian processes and environmental factors, and the interaction between these, and thus provides limited mechanistic insight.

3.4.2 Clock gene rhythms

BMAL1 expression exhibited a significant rhythm in the oral mucosa of the healthy control subjects with significant alterations in ADHD including a reduction in amplitude and hence a loss of significant rhythmicity. *PER2* expression was also significantly rhythmic in the control group, whilst rhythmicity was also lost in ADHD. Although it was observed that the average amplitude of *PER2* expression was reduced in ADHD, this between group difference was not statistically significant, and there were no significant between group differences of the area under the curve of both the *BMAL1* and *PER2* expression profiles. Furthermore, the DSM-IV ADHD score inversely correlated with the amplitude and percentage rhythm of *BMAL1* and with the amplitude of the *PER2*, indicating a relationship between the strength of clock gene rhythmic expression and clinical ADHD ratings. Thus, a role for dysfunction in the entrainment of the circadian clock in ADHD may be tentatively postulated, although it is prudent to sound a number of notes of caution. Firstly, one particular peripheral circadian clock has been examined (as sampling of the master SCN clock is obviously not possible in human studies outside of retrospective post-mortem analysis). So an explanation for the loss of rhythmicity in both *BMAL1* and *PER2* observed in the ADHD sample is that rhythmic regulation of these factors is dependent on melatonin, and as melatonin rhythmicity is lost in ADHD, this drives the loss of *BMAL1/PER2* rhythmicity. Secondly, alteration in circadian processes in peripheral pacemakers as noted here may not necessarily reflect changes in central processes (the key regulators of behaviour) or hence reflect the functioning of the master pacemaker. Having said this, it is worth noting that the characteristics of molecular rhythms in skin fibroblasts (Brown et al., 2008) and in hair follicles (Akashi et al, 2010) do correlate with behavioural measures from the subjects from whom the samples were derived, as they do in our present study (correlations between clock gene chronometrics and actigraphic period).

3.4.3 Melatonin

A robust significant rhythm of melatonin in the healthy control group was demonstrated as expected, and a loss of significant rhythmicity in adult ADHD was shown. This loss of rhythmicity was probably due to the reduced amplitude of the

melatonin rhythm, although peak melatonin levels occurred at approximately the same time as the control group. Previous studies have reported an association of altered phasing of the melatonin rhythm with both childhood ADHD (Van der Heijden et al, 2005) and adult ADHD (Van Veen et al 2010). In these cases an abnormal rhythm of melatonin secretion was associated with the disorder, where it was comorbid with chronic sleep onset insomnia, and a delayed sleep phase and delayed dim light melatonin onset was observed (Van der Heijden et al., 2005). As the dim-light melatonin onset was not examined in the current study, a direct comparison between the present findings and those noted above cannot be made. A simple explanation for the dampened amplitude of melatonin secretion in ADHD is therefore that since melatonin secretion is inhibited by light, an altered sleep wake rhythm involving more nocturnal activity, and thus increased exposure to light, could suppress the secretion of melatonin. This hypothesis was supported by the actigraphy data, which demonstrate that the ADHD group were exposed to a significantly greater amount of nocturnal light during the hours of 12am to 6am, than the control group. However melatonin also plays a role in determining the sleep wake cycle, with a characteristic rise in melatonin levels 2 hours in advance of the habitual bedtime thought to act as a “gating” mechanism for sleep onset (Macchi and Bruce, 2004, Wiechmann and Summers, 2008). It can therefore be postulated that disturbance in its rhythm may contribute to the disturbance in sleep exhibited in adult ADHD. Furthermore, as melatonin is thought to have a strong entraining influence upon the master circadian pacemaker through its ability to directly feed back to the SCN (Reppert and Weaver, 2001, Pierce et al., 2008), a dampening of the melatonin rhythm could have downstream effects upon the entrainment of the peripheral oscillators by the master circadian pacemaker.

3.4.4 Cortisol

The current data illustrated a significant rhythm of cortisol secretion in both the control group and in adult ADHD. Increased levels of cortisol in ADHD were indicated by the significantly greater area under the curve of the cortisol profile in the ADHD group in comparison to the controls. However, the rhythm of cortisol was phase delayed by approximately 2 hours in ADHD, as demonstrated by the significant difference in acrophase and amplitude/acrophase measures between the

two groups. Studies have examined the awakening cortisol response in different chronotypes, and have shown higher awakening rises in morning types compared to evening types (Kudielka et al., 2006, Randler and Schaal, 2010), suggesting that eveningness might be associated with a phase-delay of the cortisol rhythm. Furthermore, an association of reduced robustness of the cortisol rhythm with ADHD was demonstrated by the inverse correlation between DSM-IV-ADHD score and the percentage rhythm of cortisol.

As the rhythm in cortisol is known to be centrally driven via the SCN master clock, (Keller et al., 2006), the phase-delay observed in our study may further reflect a deficit in the entrainment of the master circadian clock in adult ADHD to appropriate environmental and social stimuli. It is also possible that further downstream effects of a delayed phase of the cortisol rhythm may arise from its proposed role in the entrainment of the peripheral oscillators (Van Someren and Riemersma-Van Der Lek, 2007) and this may play a key role in the entrainment of the peripheral oscillators then a delayed phase in its rhythm could contribute to the altered clock gene rhythmicity in the oral mucosa that is demonstrated here. Seemingly normal diurnal rhythms of cortisol secretion have previously been demonstrated in adult ADHD (Lackschewitz et al., 2008, Hirvikoski et al., 2009) but as these studies did not undertake chronometric analysis, these findings may simply reflect the preservation of the rhythmic cortisol levels in adult ADHD (as reported here) but would not be able to detect the alterations in the phasing of the rhythm that we report. As the rhythm in cortisol is known to be centrally driven via the SCN master clock, the phase-delay observed in this study may further reflect a deficit in the entrainment of the master circadian clock in adult ADHD to appropriate environmental and social stimuli, and could potentially affect sleep timing and duration, which in turn could contribute to the pathogenesis of ADHD.

The rhythms of *BMAL1* and *PER2* expression and salivary melatonin and cortisol were all assessed using samples that were collected at 4-hourly time-points, to be representative of the 24-hour profile. This approach was implemented since sampling at more frequent time-points could impact too greatly upon the individual's sleep-wake schedule, hence causing possible perturbations to the circadian system as a consequence. Furthermore, to impose a more frequent sampling schedule would be

problematic for participant recruitment as this would impinge too much upon the individual's social and sleep-wake schedules. However, the temporal resolution of the data must be considered when interpreting the findings, since a greater frequency of sampling would provide a more precise estimation of the chronometrics of the circadian rhythms. Nevertheless, the 4-hour sampling protocol was adequate enough to provide data that was capable of demonstrating between-group differences in circadian rhythmicity.

3.4.5 Relationship between the behavioural and molecular rhythms

Given the observed correlations between various actigraphic and chronometric parameters with the DSM-IV ADHD score, further examination of the relationships between clock gene expression, endocrine profiles and actigraphic measures of circadian rhythms and sleep were carried out.

The relationship between the actigraphic measures of sleep and the rest-activity rhythm and the chronometrics of the molecular rhythms were examined by correlation analysis. The amplitude of *BMAL1* expression was inversely correlated with amount of activity in the 10 most active hours (M10) and the time of M10 onset (M10o), which was suggestive of a link between the loss of *BMAL1* rhythmicity with both hyperactivity and a later phase of behaviour. The acrophase of the *BMAL1* rhythm exhibited a positive correlation with the actigraphic period, and an inverse relationship with period deviation, which could be interpreted such that a later peak of *BMAL1* expression is linked with increased period length of the actigraphic rhythm. *BMAL1* acrophase was also positively correlated with relative amplitude, and inversely correlated with M10o and L5, thus being suggestive of a later *BMAL1* acrophase being linked to a more robust actigraphic rhythm, with reduced hyperactivity. Since ADHD was associated with both eveningness and a reduced actigraphic period as demonstrated in the present study, and hyperactivity is a core symptom of the disorder, this would suggest that an earlier phase of the rhythm of *BMAL1* could be associated with the disorder. Furthermore, a relationship between the acrophase of *BMAL1* rhythmicity and sleep quantity is illustrated by a positive correlation between *BMAL1* acrophase and both sleep bout duration and percentage sleep, and an inverse relationship of *BMAL1* acrophase with percentage duration of

time awake. This indicated that an earlier phase of rhythmic *BMAL1* expression was associated with reduced sleep duration, which is a sleep measure that was shown to be significantly reduced in ADHD in the present study.

A link between the strength of the *PER2* rhythm and sleep quantity was indicated by a positive correlation of sleep bout duration with *PER2* amplitude and *PER2* percentage rhythm. This was of interest since reduced sleep quantity and loss of *PER2* rhythmicity have both been shown to be associated with ADHD in this study. An association of robustness of the *PER2* rhythm with an earlier phase of behaviour was provided by an inverse correlation of *PER2* amplitude with get up time. Furthermore decreased *PER2* rhythmicity also appeared to be linked with shortening of the period of behaviour, as demonstrated by significant positive correlations between the period of the actigraphic rhythm and amplitude and percentage rhythm of *PER2*, and inverse correlations between deviation of the actigraphic period from 24 hours and the amplitude and percentage rhythm of *PER2*.

3.4.6 Relationship between the behavioural and endocrine rhythms

Significant relationships between the actigraphic measures of sleep and the rest-activity rhythm were also observed with the chronometrics of the endocrine rhythms.

A significant positive correlation of percentage rhythm of melatonin with both time spent in bed and assumed sleep, and of melatonin amplitude with both assumed and actual sleep duration were observed. It could therefore be suggested that when the rhythm of melatonin is reduced and even lost as is observed in ADHD, then this could be associated with reduced sleep quantity. An association of the phase of the melatonin rhythm and sleep duration was also indicated by the positive correlation of melatonin acrophase with actual sleep duration and actual percentage sleep, and in turn an earlier phase of the melatonin rhythm was associated with increased wake duration (an inverse relationship between melatonin acrophase and actual percentage wake duration was observed). A delayed dim light melatonin onset in adult ADHD has previously been documented, and in the same subjects increased sleep duration but with less efficiency and longer sleep latency was demonstrated when ADHD was not comorbid with sleep onset insomnia (Van Veen et al., 2010).

An inverse relationship of cortisol acrophase with L5o and M10o was also noted. This therefore suggested a link between a delayed phase of behaviour and a later phase of the cortisol rhythm, which was further supported by the positive correlation of cortisol acrophase with actigraphic rhythm acrophase observed. Cortisol acrophase was positively correlated with L5, M10 and actigraphic rhythm amplitude, thus indicating that hyperactivity, a key symptom of ADHD, may be linked with a later phase of cortisol rhythmicity. Assumed sleep duration, actual sleep duration and the time spent in bed were all inversely correlated with the acrophase of the cortisol rhythm, suggesting that reduced sleep quantity, which was reported in ADHD in the present study, was also linked with a delayed phase of cortisol rhythmicity. This was further supported by the inverse correlation between the area under the curve of cortisol and both actual sleep duration and sleep efficiency, which are sleep parameters that were shown to be significantly reduced in ADHD in the present study. Additionally, as earlier described, deviation of the period of the activity rhythm from 24 hours was associated with ADHD, and an inverse correlation between the percentage rhythm of cortisol and period deviation was also shown in the present data.

Another correlation that was demonstrated was the inverse relationship between the time of sleep start and the area under the cortisol curve, thus indicating that the robustness of the cortisol rhythm was associated with an earlier sleep start and hence an earlier phase of behaviour. This was further demonstrated by an inverse correlation between the percentage rhythm of cortisol and the acrophase of the activity rhythm. However, partly contradictory to these findings was the positive correlation between percentage rhythm of cortisol with bed time and the inverse relationship between cortisol percentage rhythm and time of sleep end observed in the present study. This would suggest that the rhythm of cortisol was more robust in individuals who woke earlier in the morning and went to bed later at night. One interpretation of these findings could be that increased robustness of cortisol rhythmicity was associated with individuals who had an enforced social schedule on their sleep-wake patterns, for example in individuals who were required to wake up early to go to work. This was of interest since a regular daily schedule and hence regular environmental light exposure directly after waking has been shown to

increase the amplitude of the morning cortisol peak (Scheer and Buijs, 1999, Van Someren and Riemersma-Van Der Lek, 2007).

Collectively the numerous correlations observed between the behavioural rhythm and the molecular and endocrine rhythms demonstrate potential interactions of peripheral circadian clock gene expression and endocrine secretion with the circadian rhythm of behaviour.

3.4.7 *rs1801260 polymorphism in CLOCK*

No association of the rs1801260 polymorphism in the *CLOCK* gene with adult ADHD was observed in the present data, which is in contrast to previous studies, which showed that the T allele was associated with the disorder (Kissling et al., 2008, Xu et al., 2010). Although, the low sample number and hence lack of statistical power could be a contributing factor to the lack of group-wise differences in genotype frequencies demonstrated here. However, genotype was found to have a main effect upon *BMALI* amplitude, cortisol amplitude and cortisol percentage rhythm. The rs1801260 polymorphism is located within the 3' UTR promoter region of *CLOCK*, and therefore it could be postulated that effects of the polymorphism could be upon mRNA translatability and stability (Robilliard et al., 2002). Since *CLOCK* is an integral component of the molecular clockwork, with its role as a transcriptional activator upon dimerization with *BMALI* (Reppert and Weaver, 2002, Hastings and Herzog, 2004, Hirota and Fukada, 2004), any alterations in its normal functioning could potentially affect the expression of other core clock genes and their protein products, consequently affecting circadian clock output, and hence associated behavioural and physiological functions.

3.4.8 *Conclusions*

Significant perturbations not only in the rhythmic secretion of endocrine factors that are key outputs and regulators of the master circadian clock but also in peripheral circadian clock gene expression and actigraphic measures of circadian organization of gross behaviour were observed in ADHD. Significant correlations were also found between the clinical scores and various parameters of the behavioural, endocrine and

molecular circadian rhythms. It is therefore proposed that insufficiencies in the entrainment of the circadian clock to the light-dark cycle or other Zeitgebers could underlie the disturbance in the circadian system observed in adult ADHD. Collectively the data suggest a key role for circadian disturbance in the manifestation of sleep disturbance and the clinical symptoms of adult ADHD. Further work would aim to elucidate potential therapeutic roles for bright light therapy and melatonin administration in the treatment of ADHD symptoms. Further research into modulation of circadian deficits in ADHD may prove beneficial in understanding the underlying causes of the symptomology and may serve to aid in appropriate and efficacious treatment of the disorder.

**Chapter 4: The effects of ADHD medication upon circadian clock
protein expression in the rodent brain**

Chapter 4: The effects of ADHD medication upon circadian clock protein expression in the rodent brain

4.1 Introduction

Pharmacological treatments for ADHD

Currently the two of the main forms of pharmacological treatment for ADHD are predominantly the psychostimulant methylphenidate, and to a lesser degree and more recently the anti-depressant atomoxetine (Biederman and Faraone, 2005). Both drugs exert their therapeutic action through manipulation of the catecholaminergic systems, with methylphenidate inducing increases in synaptic concentration of both dopamine and noradrenaline (Madras et al., 2005, Kim et al., 2010), whereas atomoxetine acts to increase mainly just synaptic noradrenaline levels (Kim et al., 2010). The precise mechanism by which dopamine and noradrenaline levels are increased by methylphenidate treatment are thought to be due to inhibition of their associated transporters proteins; the dopamine transporter (DAT) and the norepinephrine transporter (NET), which prevents re-uptake of both catecholamines thus facilitating their accumulation in the synapse (Madras et al., 2005, Sangal et al., 2006, Kim et al., 2010). Atomoxetine is also an inhibitor of NET, and upon binding to the transporter it prevents removal of noradrenaline from the synapse, but with minimal affinity for DAT (Kim et al., 2010).

Methylphenidate and atomoxetine effects upon sleep

Various effects of methylphenidate and atomoxetine upon sleep patterns of both childhood and adult ADHD patients have been documented (Sangal et al., 2006, Boonstra et al., 2007, Sobanski et al., 2008). Improvements to sleep in adult ADHD by methylphenidate treatment have been observed including a reduced number of actigraphically assessed nocturnal awakenings and an increase in nocturnal periods of uninterrupted sleep (Boonstra et al., 2007). A polysomnographic study also demonstrated a significant reduction in sleep onset latency and improved sleep efficiency in patients undergoing methylphenidate treatment (Sobanski et al., 2008). To the contrary an actigraphic study reports increased sleep onset latency in adult

ADHD patients undergoing methylphenidate treatment (Boonstra et al., 2007), and insomnia has been documented in both methylphenidate medicated childhood and adult ADHD patients (Sangal et al., 2006) with the effect of the stimulant treatment wearing off being postulated as playing in role in sleep disturbance, causing greater difficulty in falling asleep and reduced sleep duration (Sangal et al., 2006). Atomoxetine treatment has been shown to improve both parental and self reported sleep in childhood ADHD, including a reduction in both time to fall asleep and difficulty to settle down, and an improvement in ease of getting up in the morning (Sangal et al., 2006). Furthermore, research directly comparing the effects of methylphenidate and atomoxetine upon sleep in childhood ADHD have indicated that atomoxetine has more beneficial effects upon sleep than that of methylphenidate, with increased reports of insomnia and increased sleep onset latency when being treated with methylphenidate as oppose to atomoxetine and when un-medicated (Sangal et al., 2006). Furthermore atomoxetine treatment improved childhood ADHD symptoms in the morning and evening compared to methylphenidate treatment (Sangal et al., 2006). However, a reduction in the number of sleep interruptions/awakenings were observed during the period of methylphenidate treatment in comparison to atomoxetine treatment and un-medicated periods (Sangal et al., 2006).

Moreover, the efficacy of methylphenidate treatment of ADHD has been shown to be dependant upon the time of administration, with morning administration in childhood ADHD patients being shown to improve attention during the daytime, but to cause behavioural and sleep problems in the evening (Boonstra et al., 2007). Whereas, late afternoon administration of methylphenidate appeared to reduce the problematic side effects upon sleep, whilst still exerting considerable therapeutic action (Kent et al., 1995, Boonstra et al., 2007).

The observed interactions of methylphenidate and atomoxetine with the sleep/wake cycle are not entirely surprising since aspects of both the dopaminergic and noradrenergic systems are implicated in circadian clock functioning. Dopamine neurons have been shown to play a role in the regulation of light input to the retina (Witkovsky, 2004, McClung et al., 2005) and noradrenaline has been proposed as an entrainment signal originating from the SCN to entrain the peripheral oscillator of

the pineal gland (Wongchitrat et al., 2009). Furthermore, the extracellular concentrations of dopamine and noradrenaline exhibit a circadian rhythm in various brain regions (Smith et al., 1992, Paulson and Robinson, 1994, Drijfhout et al., 1996, Paulson and Robinson, 1996, Castaneda et al., 2004).

Pharmacological effects upon the circadian system of the rodent brain

The rodent brain is a model widely used in circadian studies, as direct assessment of *in vivo* effects upon the master circadian clock of the SCN and the slave oscillators in the periphery of the human brain is limited to post mortem tissue, which is susceptible to known perturbations of the circadian system in various disease states (Wu et al., 2006, Tseng et al., 2010) and with aging (Ando et al., 2010, Wyse and Coogan, 2010).

Earlier studies have demonstrated various interactions of pharmacological agents of the catecholaminergic systems with the rodent circadian system, including the opiates; morphine and heroine (Li et al., 2009a, Li et al., 2009b), the anti-depressant fluoxetine (Uz et al., 2005) the antipsychotic haloperidol (Coogan et al., 2011) and the psychostimulants; amphetamine (Paulson and Robinson, 1996, Gaytan et al., 1999), methamphetamine (Honma et al., 1986, Honma et al., 1988, Moriya et al., 1996, Masubuchi et al., 2001, Iijima et al., 2002, Yamamoto et al., 2005) and cocaine (Abarca et al., 2002, McClung et al., 2005, Uz et al., 2005). Furthermore it is well documented that under conditions of chronic methamphetamine administration the rodent circadian rhythms becomes de-synchronised from the LD cycle and exhibits rhythmicity that is entirely independent of the SCN (Honma et al., 1986, Tataroglu et al., 2006, Honma et al., 2008), and hence indicates the presence of an extra-SCN methamphetamine sensitive oscillator that employs alternative circadian clock machinery to that of the SCN (Mohawk et al., 2009).

As of yet there have been no documented investigations to examine the effects of atomoxetine upon the rodent circadian system, although the effects of chronic methylphenidate upon the rodent behavioural rhythm has been investigated. Chronic methylphenidate treatment was shown to produce a circadian activity rhythm in arrhythmic SCN-lesioned rats (Honma and Honma, 1992). Furthermore, chronic

methylphenidate administration has been shown to alter the rodent diurnal locomotor rhythm in a dose-dependant manner (Algahim et al., 2009, Algahim et al., 2010, Lee et al., 2010). A phase shift in the activity rhythm of adult male rats was elicited by prolonged administration of a moderate dose that corresponds to peak plasma methylphenidate concentrations within the clinical dose range (Algahim et al., 2009). Whereas chronic methylphenidate treatment only altered the diurnal activity rhythm of young male rats when administered at a high dose (Algahim et al., 2010). Time-of day effects upon the action of methylphenidate have also been reported, with behavioural sensitization to methylphenidate being demonstrated to vary over the 24-hour cycle, with the greatest sensitization of rats to methylphenidate occurring during the light phase, and minimal sensitization during the dark phase (Gaytan et al., 2000).

Given the evidence of interactions of ADHD medication with the sleep wake cycle and the widely documented effects of psychoactive drugs upon the circadian system, it was therefore of interest to investigate how ADHD medications may modulate the molecular clockwork that form the basis of the circadian system. Therefore the main aims of this study were to examine and compare the effects of chronic methylphenidate and chronic atomoxetine upon the expression of circadian clock gene protein products in the mouse brain.

4.2 Methods

Animals

C57Bl/6J mice (n=75, 8 weeks of age, Charles River, UK) were housed in cages of three, with *ad libitum* access to food and water, and constant temperature and humidity, and were habituated to the housing conditions prior to beginning the experiments. The mice were subject to a 12:12 light/dark cycle, with lights on at 6am (designated Zeitgeber Time ZT0), using standard fluorescent light bulbs (~100 lux at cage level). These experiments adhered to the guidelines outlined in the Animals (Scientific Procedures) Act, 1986, the European Communities Council Directive 86/609 and by the Research Ethics Committee, School of Medicine, Swansea University. Every effort was made to minimise the animal numbers and suffering experienced.

The mice underwent chronic treatment of either 2.5mg/kg methylphenidate (Methylphenidate hydrochloride, Sigma-Aldrich, UK), 2.0mg/kg atomoxetine (Tomoxetine hydrochloride, Tocris Bioscience, UK) or a 0.9% saline control, and 24 mice were assigned to each of these treatment groups. The doses chosen were according to previous literature, as they produce peak plasma levels within the clinical dose range in humans (Kuczenski and Segal, 2002, Algahim et al., 2009). The injections were equalized to a volume of 100µl with 0.9% saline and administered intraperitoneally, once a day at ZT2 (8am) for 7 days. The time of administration was chosen two hours into their light phase (sleep phase) to minimise disturbance to their sleep/wake cycle.

On day 7 the mice were killed, and 6 mice were killed from each treatment group at each of the 4 sampling time-points: ZT2, ZT8, ZT14 and ZT20. This procedure was carried out in a light-proof room and under infra-red light for those mice sampled in the dark phase of the cycle. Mice were anaesthetised with chloral hydrate (pH 7.04), prior to transcardial perfusion with 4% paraformaldehyde (PFA). Once the brains were removed, they were post-fixed in 4% PFA at 4°C overnight, and then stored in 0.1M phosphate buffer (PBS, pH7.4) at 4°C. The brains were then transferred into 30% sucrose at 4°C until fully saturated, for cryoprotection.

The brains were sliced into 30µm sections using a freezing-stage sliding microtome (Leica, Germany). The brain was mounted onto to the cutting platform of the microtome using embedding compound and maintained at -30°C whilst sectioning. Four serial sets of sections were collected from each brain and were stored in PBS containing 0.01% sodium azide (Sigma-Aldrich, USA) at 4°C, to prevent fungal growth.

Immunohistochemistry

Free-floating sections were processed for c-Fos, PER2, PER1 and CLOCK immunohistochemistry. Primary and secondary polyclonal antibody staining with the binding of an avitin-biotin complex was used, as this method increases the antibody to signal ratio and so gives a high intensity of staining. The protocol consisted of a series of steps where the sections were incubated in solutions of 1ml volume. The solutions were changed using a hand pipette. This method reduced contact with the sections so that damage to the sections was minimized. During incubations the trays of sections were mixed on a see-saw rocker.

The sections were washed in PBS twice for 10 minutes each, to remove the sodium azide and any tissue debris. The sections were then incubated with 0.1M PBS and 0.03% Triton-X-100 (PBX, Sigma-Aldrich, UK) for 10 minutes, to permeabilise the sections. This was followed by the incubation of the sections for 20 minutes in a PBS solution containing 1.5% hydrogen peroxide (Sigma-Aldrich, UK) to inhibit peroxidase activity. This was followed by two washes in PBS and a wash in PBX. The sections were then blocked in serum for 1 hour at room temperature to prevent non-specific binding of the primary antibody. The sections that were undergoing CLOCK and PER1 detection were blocked in PBX containing 5% donkey serum (Sigma-Aldrich, UK). The sections undergoing c-Fos and PER2 detection were blocked in PBX containing 5% normal goat serum (NGS, Sigma-Aldrich, UK). The sections then underwent primary antibody incubation at 4°C using the following conditions:

c-Fos: PBX solution containing the rabbit polyclonal c-Fos primary antibody (dilution 1:8000; Santa Cruz Biotechnology, UK) and 2% NGS for 18 hours.

PER2: PBX solution containing the rabbit polyclonal PER2 primary antibody (dilution 1:1000; Alpha Diagnostic International, USA) and 2% NGS for 42 hours.

PER1: PBX solution containing the goat polyclonal PER1 primary antibody (dilution 1:500; Santa Cruz Biotechnology, UK) and 2% donkey serum for 42 hours.

CLOCK: PBX solution containing the goat polyclonal CLOCK primary antibody (dilution 1:500; Santa Cruz Biotechnology, UK) and 2% donkey serum for 42 hours.

The sections were washed twice with PBS and once with PBX, before incubation with biotinylated secondary antibodies, for 70 minutes, in light-proof conditions at room temperature:

PER2 & c-Fos: PBX solution containing goat anti-rabbit secondary antibody (1:400; Vector Laboratories, UK) and 2% NGS.

PER1 & CLOCK: PBX solution containing rabbit anti-goat secondary antibody (1:400; Jackson Laboratories, USA) and 2% donkey serum.

The sections were then washed twice in PBS and once in PBX, before being incubated with a premixed PBX solution containing the avidin-biotin complex (0.4%; Vector Laboratories, UK) for 90 minutes in light-proof conditions at room temperature. The sections were then washed twice in PBS, followed by a wash for 10 minutes in 0.1M sodium acetate (Sigma-Aldrich, USA) to lower the pH of the sections to pH6. The sections were then incubated with nickel-enhanced Diaminobenzidine (nickel DAB) and glucose oxidase (Sigma-Aldrich, USA). The staining for c-Fos was developed in 5 minutes, PER2 in 2 minutes, PER1 in 4.5 minutes and CLOCK in 4.5 minutes. The sections were then moved to a solution of 0.1M sodium acetate (pH6) to stop the staining reaction. All sections underwent these same standard conditions, in order to minimise inter-assay variability.

Specificity of the staining of the target proteins was confirmed by processing separate sections using the same standard immunohistochemistry protocols described above, but with the primary antibody incubated prior to the procedure with its immunizing peptide, to block its activity (Figure 4.1).

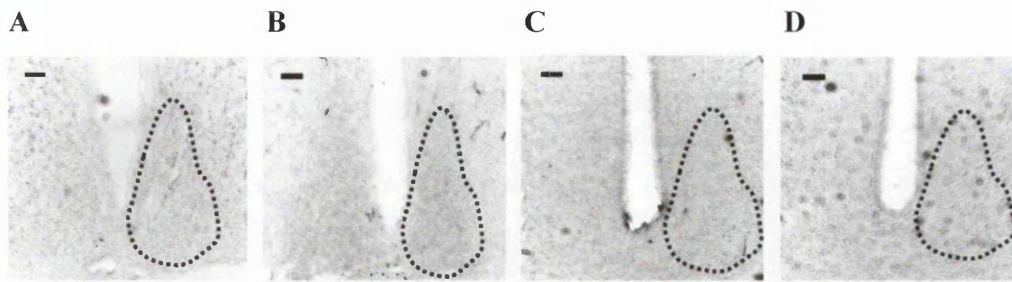

Figure 4.1. Photomicrographs of immunostaining in the SCN (dotted line) of saline control mice, using primary antibodies that have been blocked with the corresponding immunizing peptide. (A) c-Fos, (B) CLOCK, (C) PER1, (D) PER2. Scale bars = 100 μ m. Minimal immunoreactive cells were detected in each case, indicating specificity of the primary antibody.

The sections were then washed twice in PBS and mounted in dilute PBS onto polycycline-coated microscope slides (Fisher-Scientific, UK). The sections were then left to dry out overnight. Once dried the mounted sections underwent dehydration and delipifying steps using Ethanol (Fisher-Scientific, UK) and HistoClear (National Diagnostics, UK): 3 minutes in 70% ethanol, 3 minutes in 95% ethanol, 2 steps of 3 minutes in 100% ethanol, and finally 2 steps of 3 minutes in histoclear. The sections were then coverslipped using mounting media (Entellan; Merck, UK).

Image analysis

The Zeiss Axioskop light microscope (Zeiss, Jena, Germany) equipped with an Axiocam digital camera was used to examine the brain sections. Three to six images were quantitated per time-point, region and mouse. Two measures of immunoreactivity, the optical density and the cell/count per area, were calculated using image analysis software (ImageJ 1.43u, National Institutes of Health, USA). For the counting of immunoreactive cells, the images were adjusted for background, and a threshold value was set that was optimal for the visualisation of each antigen. For the measurement of optical density, both the optical densities of the region of interest and an unstained control region were measured. The optical density of the control region was subtracted from the optical density of the region of interest to allow for calculation of the optical density adjusted for non-specific staining. Anatomical regions were identified according to the stereotaxic co-ordinates defined

in the mouse brain atlas (Paxinos and Franklin, 2004). Immunoreactivity was examined in the suprachiasmatic nuclei (SCN) at the mid-rostral level, the paraventricular nucleus of the hypothalamus (PVN), the dorsal medial nucleus of the hypothalamus (DMH), the basolateral (BLA) and central (CeA) amygdala, the hippocampus (CA1, CA3, dentate gyrus (DG)), the caudate putamen (CPu), the ventral tegmental area (VTA), the nucleus accumbens including the core (ACBC) and shell (ACBSH) regions, and the cerebral cortex including the prefrontal infralimbic cortex (ILC), the prefrontal prelimbic cortex (PLC) and the cingulate cortex (CC).

Statistical analysis

Average immunoreactivity was calculated per mouse, time-point, treatment group and brain region. The statistical software SPSS (IBM Corporation, USA) was used on a PC to test for significant main effects of time and treatment by 2-way ANOVA, with *Tukey* post-hoc testing to describe specific effects within main effects.

Cosinor analysis was performed on a PC using statistical software (CircWave v1.4, Department of Chronobiology, University of Groningen, Netherlands), to test whether the data exhibited a significant circadian rhythm. This program determines if a statistically significant ($p < 0.05$) sinusoidal wave can be fitted to the data, by automatically adding harmonics to the wave fit to best describe the data. The following function describes the wave-form:

$$f(t) = a + \sum_{i=1}^{\infty} \left[p_i \sin i2\pi \frac{t}{\tau} + q_i \cos i2\pi \frac{t}{\tau} \right]$$

Where a is the average; i is either 1, 2, 3, when 1 it indicates the fundamental wave, when 2 it describes the first harmonic, when 3 it describes the second harmonic. p_i is the sine coefficient of the $(i-1)^{\text{th}}$ harmonic, q_i is the coefficient of the $(i-1)^{\text{th}}$ harmonic; t is the time-point value (modulo τ); $f(t)$ is the calculated function value at time point t , a and b are linear estimates for the sine and cosine contribution to a flat line (when $i=0$), the fundamental wave ($i=1$), first harmonic ($i=2$), second harmonic ($i=3$).

4.3 Results

CLOCK, PER1, PER2 and c-Fos immunoreactivity were assessed both densitometrically and by quantification of immunoreactive cells in the SCN, PVN, CC, CPu and in the VTA, whilst immunoreactivity in all other brain regions analysed, were assessed by immunoreactive cell quantification alone. The measurement of a significant co-sinor fit and acrophase were equivalent between the two methods in all cases (appendix 1), and therefore immunoreactive cell count data alone is presented in the main text. The staining of the CLOCK, PER1, PER2 and c-Fos gene expression protein products in all of the brain regions examined was predominantly nuclear (figures 4.3, 4.5, 4.7, 4.9, 4.11, 4.13, 4.15, 4.17, 4.19, 4.21, 4.23, 4.25, 4.27, 4.29, 4.31, 4.33, 4.35, 4.37, 4.39, 4.41). Significant main effects of time and treatment upon protein expression were assessed by 2-way analysis of variance (ANOVA) with tukey *post-hoc* testing to determine the specific effects within the main effects demonstrated. Co-sinor analysis was used to determine if there was a significant rhythmic pattern of protein expression.

4.3.1 Circadian clock protein expression in the hypothalamus

CLOCK expression in the hypothalamus

CLOCK was expressed in the all three regions of the hypothalamus examined; SCN, PVN and the DMH (figures 4.2-4.3). Its expression was not rhythmic in the SCN of the saline control mice (figure 4.2A, table 4.1). However, there was a significant rhythm of CLOCK gene protein product expression in the DMH and PVN of these mice, with acrophases at ZT8 (figures 4.2D and 4.2G, table 4.1). CLOCK expression in the SCN of the methylphenidate and atomoxetine treated mice however, was not rhythmic (figures 4.2B-C, table 4.1). Rhythmic expression of CLOCK in the DMH of the methylphenidate and atomoxetine treated mice with an acrophase at ZT2, 6 hours in advance of the acrophase observed in the saline control mice was detected (figures 4.2E-F, table 4.1). The expression of CLOCK in the PVN was rhythmic with an acrophase in the early subjective day exhibited by both the methylphenidate and atomoxetine treated mice (figures 4.2H-J, table 4.1). No significant main effect of time, treatment, or interaction of time and treatment were detected upon CLOCK

expression in the SCN and DMH. However, a significant effect of time upon PVN CLOCK expression was shown ($df=3$, $F=2.986$, $P<0.05$), and a main effect of treatment was nearing significance ($df=2$, $F=3.018$, $P=0.057$), whilst there was no interaction of time and treatment detected.

Brain region	Treatment	Acrophase of Immunoreactivity (h)			
		CLOCK	PER1	PER2	c-Fos
SCN	SAL	n.s.	~ZT14	~ZT14	~ZT6
	MPD	n.s.	~ZT14	~ZT2	~ZT6
	ATO	n.s.	~ZT14	n.s.	~ZT6
DMH	SAL	~ZT8	~ZT8	n.s.	~ZT14
	MPD	~ZT2	~ZT2	n.s.	~ZT2
	ATO	~ZT2	~ZT2	n.s.	~ZT2
PVN	SAL	~ZT8	~ZT14	~ZT14	~ZT20
	MPD	~ZT5	n.s.	~ZT14	~ZT20
	ATO	~ZT5	~ZT2	~ZT20	~ZT8

Table 4.1. Acrophases of rhythmic immunoreactivity of CLOCK, PER1, PER2 and c-Fos in the hypothalamus of each treatment group; saline (SAL), methylphenidate (MPD) and atomoxetine (ATO), assessed by co-sinor analysis. n.s = not significantly rhythmic.

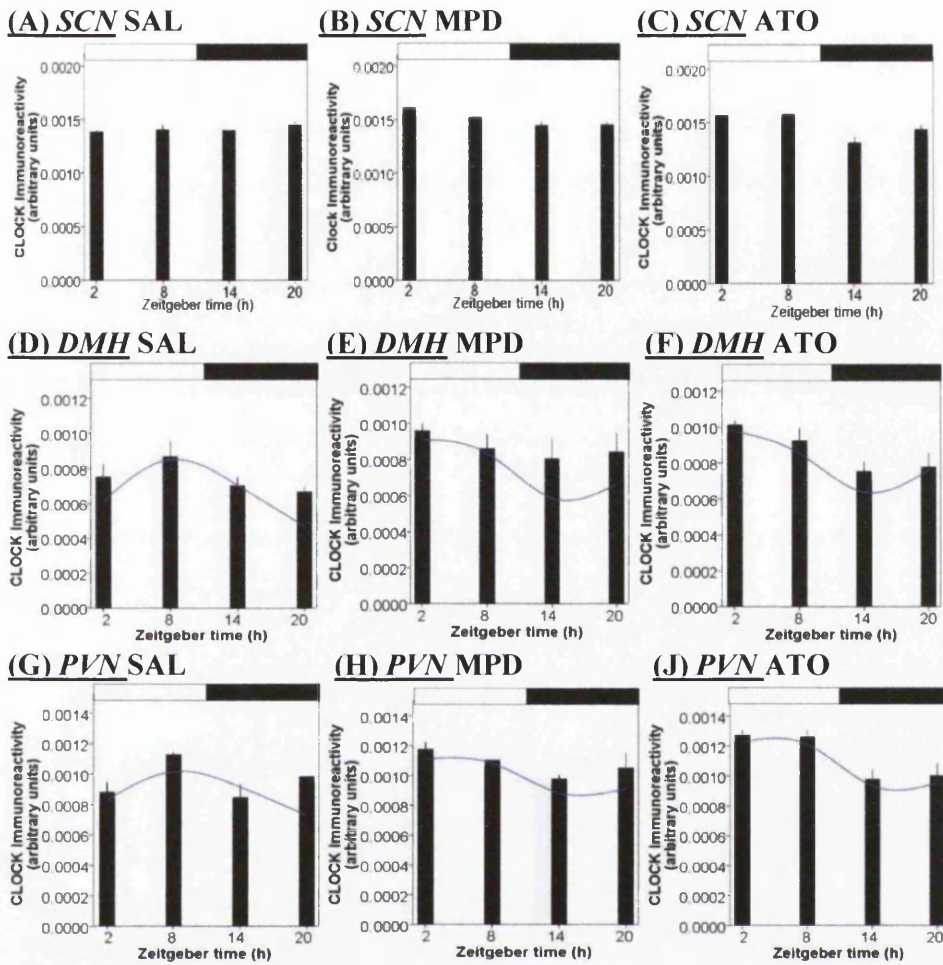

Figure 4.2. CLOCK immunoreactivity measured as immunoreactive cell counts in the SCN, DMH and PVN of mice chronically treated with either saline control, MPD or ATO. A fitted curve indicates rhythmic expression assessed by co-sinor analysis.

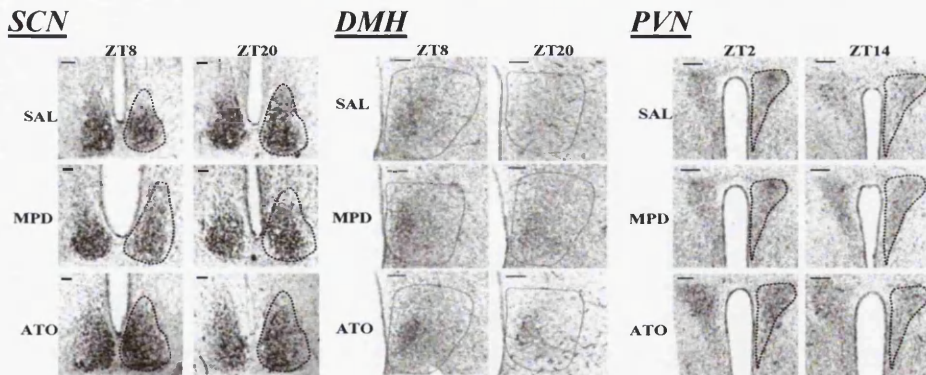

Figure 4.3. Photomicrographs of CLOCK immunostaining in the SCN and DMH during the mid subjective day (ZT8) and mid subjective night (ZT20) and in the PVN during the early subjective day (ZT2) and early subjective night (ZT14) of mice that underwent chronic treatment of MPD, ATO or a saline control. Scale bars = 100 μ m.

PER1 expression in the hypothalamus

PER1 expression was observed in all three hypothalamic regions examined (figure 4.5, table 4.1). The saline control mice exhibited rhythmic expression of PER1 in the SCN, DMH and PVN, peaking at ZT14, ZT8 and ZT14 respectively (figures 4.4A, 4.4D, 4.4G, table 4.1). There was a significant effect of time upon PER1 expression in the SCN ($df=3$, $F=42.603$, $P<0.001$). There was no significant main effect of treatment upon SCN PER1 expression and PER1 expression in the SCN of chronic methylphenidate and chronic atomoxetine treated mice was rhythmic, with acrophases unaltered from that of the saline control, peaking at ZT14 (figures 4.4A-C, table 4.1). A significant effect of time upon PER1 expression was observed in the DMH ($df=3$, $F=4.463$, $P<0.01$). Although no main effect of treatment or interaction of time and treatment were observed, there was a shift in acrophase of PER1 expression in the DMH of animals who underwent chronic methylphenidate and atomoxetine treatment to ZT2 in comparison to an acrophase at ZT8 in the saline control (figures 4.4D-F, table 4.1). A loss of rhythmicity of PER1 expression in the PVN of chronic methylphenidate treated mice and a shift in the acrophase of rhythmic PER1 expression in the PVN of atomoxetine mice to ZT2 was shown (figures 4.4H-J, table 4.1). Furthermore there was a significant main effect of treatment upon PER1 expression in the PVN ($df=2$, $F=24.358$, $P<0.001$). *Post-hoc* testing showed PER1 expression was increased in the PVN of chronic methylphenidate treated mice in comparison to chronic atomoxetine treated mice and the saline control mice ($P<0.001$), and PER1 expression in the PVN of mice that had been chronically treated with atomoxetine was dampened in comparison to the methylphenidate treated mice and the saline control mice ($P<0.001$).

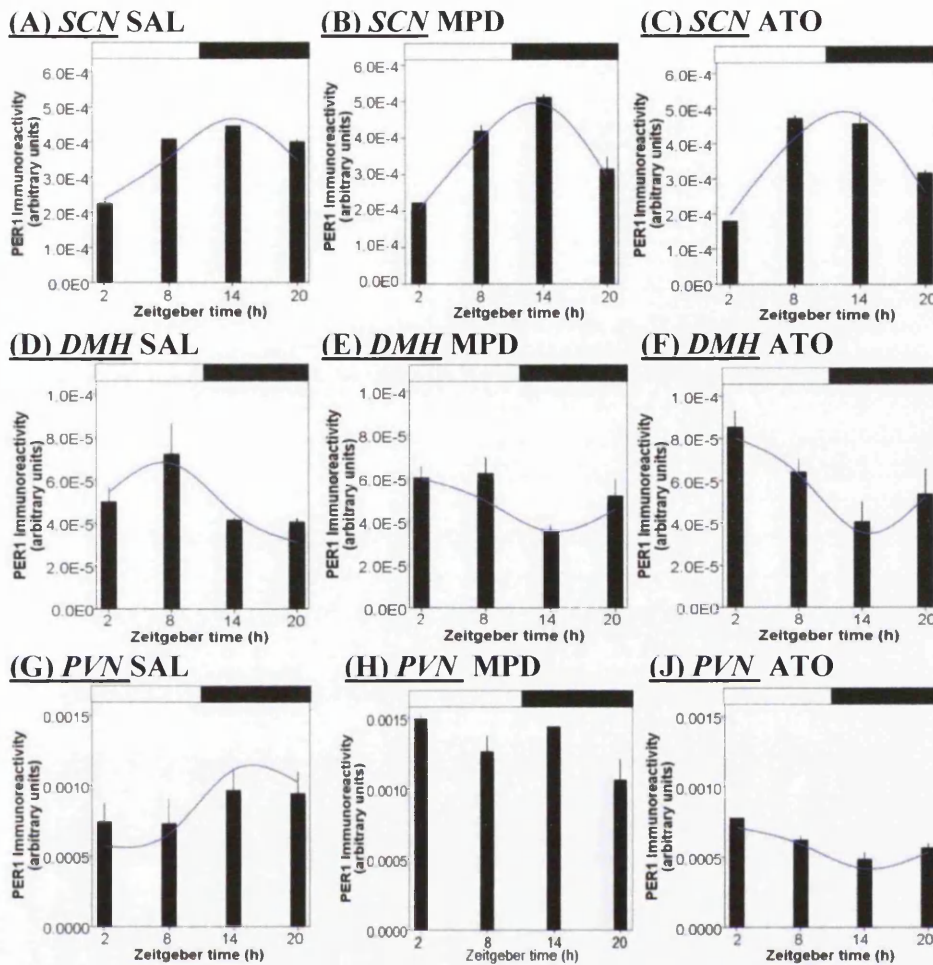

Figure 4.4. PER1 immunoreactivity measured as immunoreactive cell counts in the SCN, DMH and PVN of mice chronically treated with saline control (SAL), MPD or ATO. A fitted curve indicates a significant rhythm assessed by co-sinor analysis.

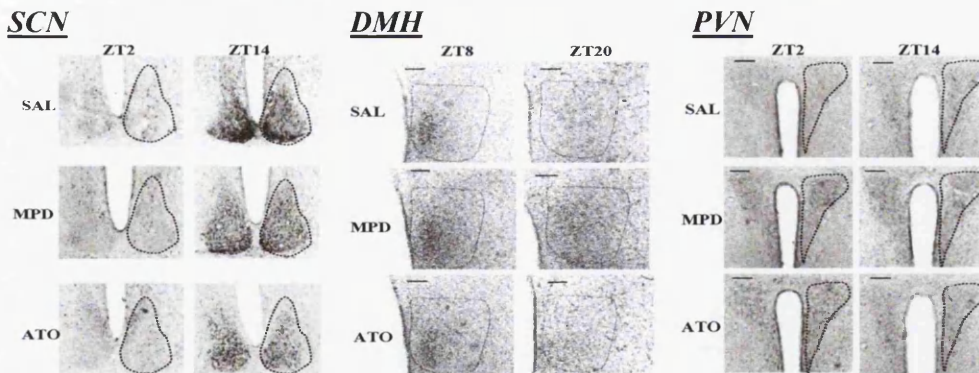

Figure 4.5. Photomicrographs of PER1 immunostaining in the SCN and PVN (early subjective day (ZT2) and early subjective night (ZT14) and in the DMH (mid subjective day (ZT8) and mid subjective night (ZT20), of mice chronically treated with either MPD, ATO or saline control. Scale bars = 100µm.

PER2 expression in the hypothalamus

In the SCN and PVN of the saline control mice PER2 expression was rhythmic, with an acrophase of ZT14 (figures 4.6A and 4.6G, table 4.1), whilst arrhythmic lower levels of PER2 expression were observed in the DMH of these mice (figure 4.6D, table 4.1). There was a shift in the acrophase of the rhythmic expression of PER2 to ZT2 in the SCN of mice that were subject to chronic methylphenidate treatment and a loss of significant rhythmic expression of PER2 in the SCN of chronic atomoxetine treated mice (figures 4.6B and 4.6C respectively, table 4.1). A significant main effect of treatment upon PER2 expression in the SCN ($df=2$, $F=34.953$, $P<0.001$) was shown and a significant interaction of time and treatment was observed ($P<0.001$), although there was no significant main effect of time. PER2 expression was reduced in the SCN of methylphenidate treated mice ($P<0.01$) and atomoxetine treated mice ($P<0.001$) in comparison to the saline control. The atomoxetine treated mice also exhibited reduced PER2 expression in the SCN in comparison to the methylphenidate treated mice ($P<0.001$). PER2 expression in the DMH of methylphenidate and atomoxetine treated mice did not exhibit rhythmicity, similarly to the saline control (figures 4.6E-F, table 4.1), and there was also no effect of time, treatment, or interaction of time and treatment upon PER2 expression in the DMH. PER2 expression was rhythmic in the PVN of methylphenidate and atomoxetine treated mice, with an acrophase at ZT14 and ZT20 respectively (figures 4.6H-J, table 4.1). Although there was no significant main effect of time, or interaction of time and treatment, there was a significant main effect of treatment upon PER2 expression in the PVN ($df=2$, $F=161.437$, $P<0.001$) and *post-hoc* testing revealed that in comparison to the saline control, PER2 expression was significantly reduced in the PVN of methylphenidate treated mice ($P<0.001$) and atomoxetine treated mice ($P<0.001$), with PER2 expression being further reduced in the atomoxetine treated mice in comparison to the methylphenidate treated mice ($P<0.01$).

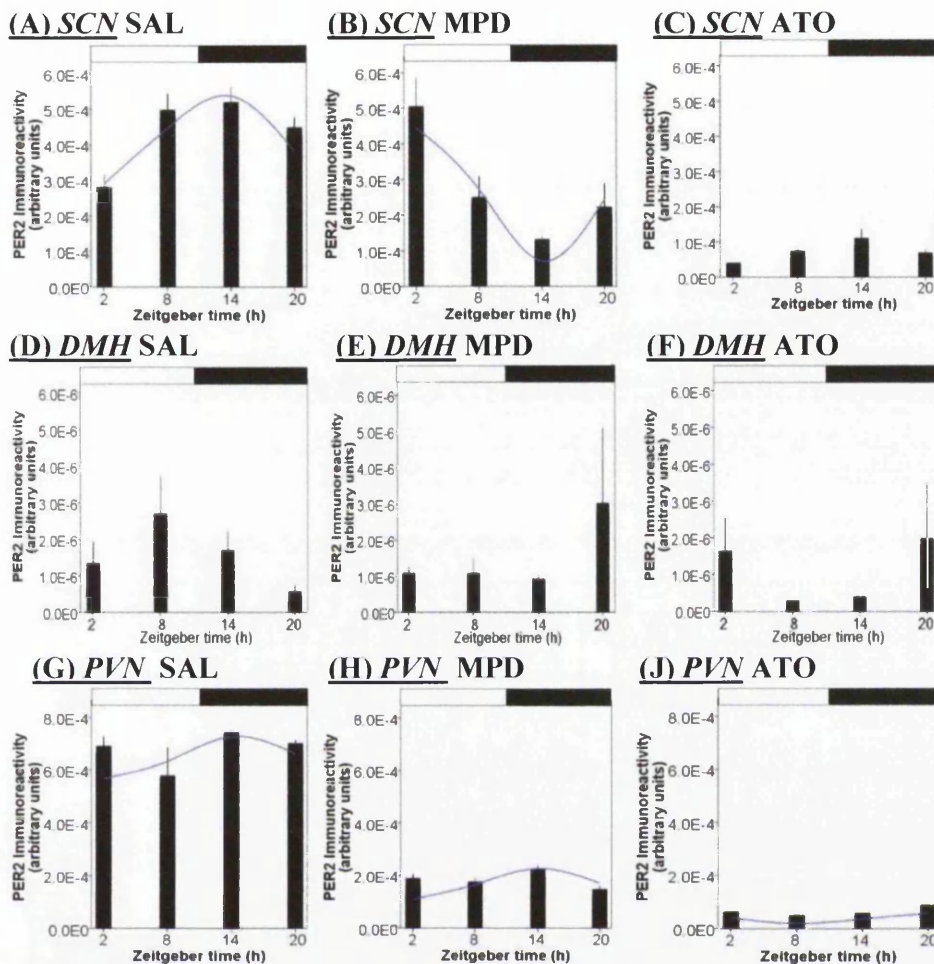

Figure 4.6. PER2 immunoreactivity measured as immunoreactive cell counts in the SCN, DMH and PVN of mice chronically treated with either saline control, MPD or ATO. A fitted curve indicates a significant rhythm assessed by co-sinor analysis.

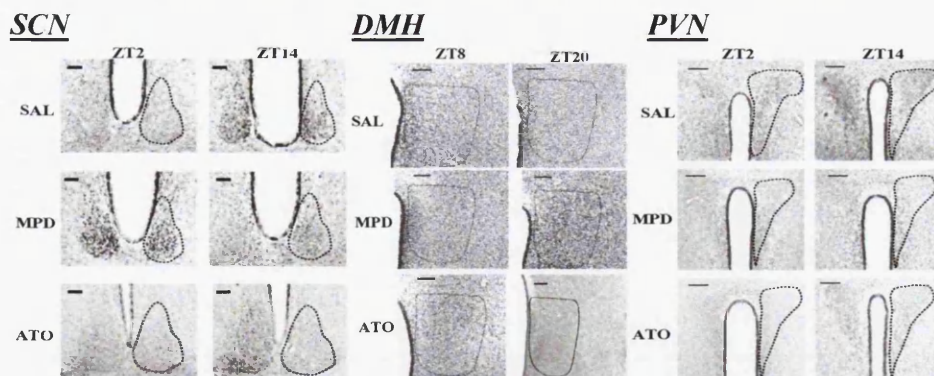

Figure 4.7. Photomicrographs of PER2 immunostaining in the SCN and PVN (early subjective day (ZT2) and early subjective night (ZT14)) and in the DMH (mid subjective day (ZT8) and mid subjective night (ZT20)) of mice chronically treated with either MPD, ATO or saline control (SAL) Scale bars = 100µm.

cFos expression in the hypothalamus

cFos was rhythmically expressed in the SCN, DMH and PVN of the saline control mice, with acrophases of ZT8, ZT14 and ZT20 respectively (figures 4.8A, 4.8D, 4.8G, table 4.1). The expression of c-Fos was rhythmic in the SCN of both the methylphenidate and atomoxetine treated mice, and was unaltered from that of the saline control, with an acrophase at ZT8 (figures 4.8B-C, table 4.1). There was a significant effect of time upon c-Fos expression in the SCN ($df=3$, $F=21.796$, $P<0.001$), but no effect of treatment or interaction of time and treatment. The acrophase of rhythmic c-Fos expression in the DMH exhibited a 12-hour shift to peak at ZT2 in the methylphenidate and atomoxetine treated mice compared to the saline control (figures 4.8E-F, table 4.1). A significant main effect of treatment upon c-Fos expression in the DMH was observed ($df=2$, $F=6.264$, $P<0.01$), with an increase in c-Fos expression in the DMH of animals chronically treated with methylphenidate in comparison to atomoxetine ($P<0.05$) and saline ($P<0.01$), whilst there was no significant effect of time or interaction of time and treatment. The acrophase of rhythmic c-Fos expression in the PVN of atomoxetine treated mice shifted to ZT8, in comparison to an acrophase of ZT20 observed in the methylphenidate treated mice and the saline control (figures 4.8G-J, table 4.1). In the PVN there was no significant main effect of treatment or time upon c-Fos expression, although there was a significant interaction of time and treatment ($df=6$, $F=4.108$, $P<0.01$).

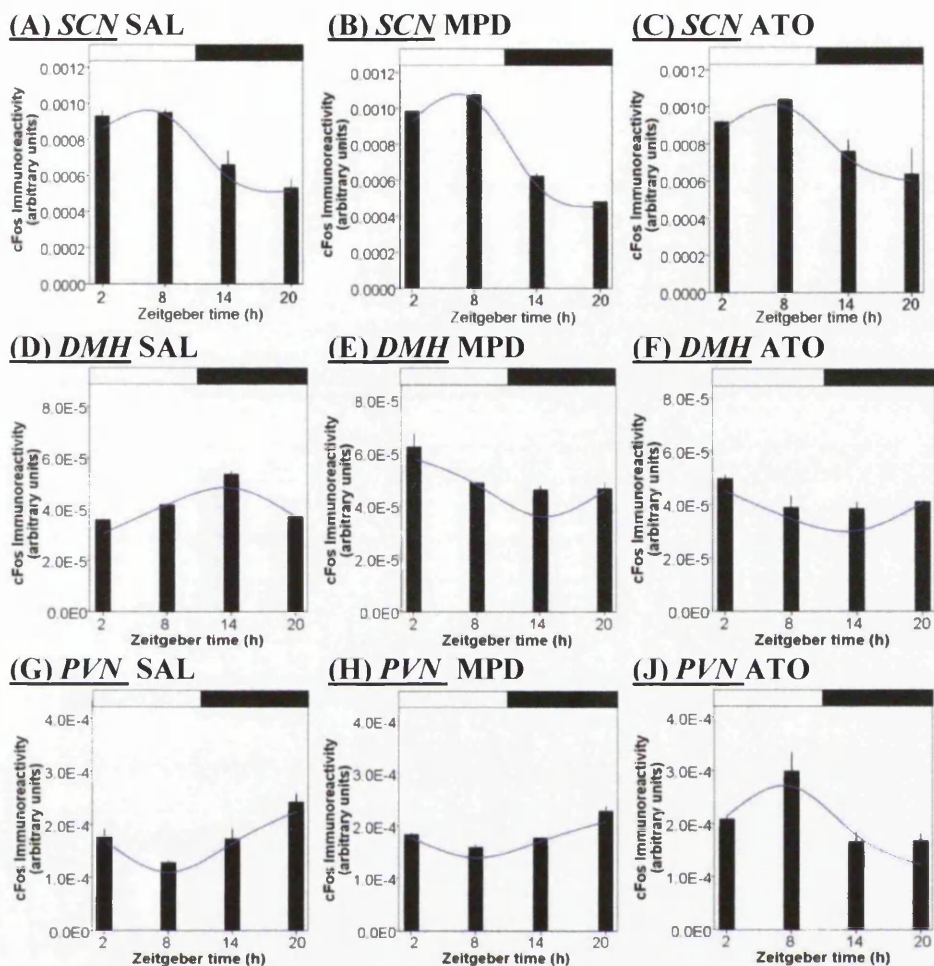

Figure 4.8. c-Fos immunoreactivity measured as immunoreactive cell counts in the SCN, DMH and PVN of mice chronically treated with saline control (SAL), MPD or ATO. A fitted curve indicates a significant rhythm assessed by co-sinor analysis.

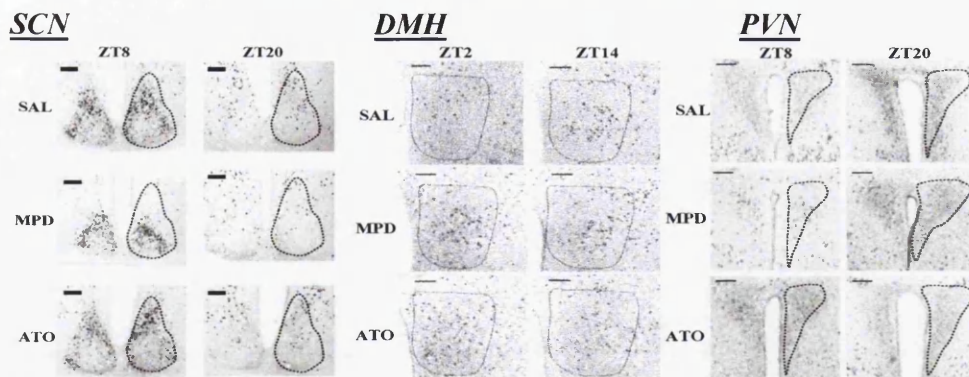

Figure 4.9. Photomicrographs of c-Fos immunostaining in the SCN and PVN during the mid subjective day (ZT8) and mid subjective night (ZT20) and in the DMH during the early subjective day (ZT2) and the early subjective night (ZT14), of mice that underwent chronic treatment of MPD, ATO or saline control (SAL). Scale bars = 100 μ m.

4.3.2 Circadian clock protein expression in the limbic forebrain

CLOCK expression in the limbic forebrain

CLOCK was expressed in all regions of the limbic forebrain examined; CA1, CA3 and DG of the hippocampus, and the BLA and the CEA of the amygdala. The expression of CLOCK was not significantly rhythmic in any of the regions of the limbic forebrain examined in the saline control mice or the methylphenidate treated mice (figures 4.10A-B, 4.10D-E, 4.10G-H, 4.10K-L, 4.10N-P, table 4.2). However there was a significant rhythm of CLOCK expression in the BLA of the atomoxetine treated mice, with an acrophase at ZT2 (figure 4.10M, table 4.2), whilst CLOCK expression was not significantly rhythmic in the CA1, CA3, DG and CEA of the atomoxetine treated mice (figures 4.10C, 4.10F, 4.10J, 4.10Q, table 4.2). No significant main effects of treatment, time, or interaction of time and treatment upon CLOCK expression in the any of the regions of the limbic forebrain examined was observed.

Brain region	Treatment	Acrophase of Immunoreactivity (h)			
		CLOCK	PER1	PER2	c-Fos
CA1	SAL	n.s.	~ZT2	n.s.	n.s.
	MPD	n.s.	n.s.	n.s.	~ZT2
	ATO	n.s.	~ZT2	~ZT2	n.s.
CA3	SAL	n.s.	~ZT2	n.s.	n.s.
	MPD	n.s.	n.s.	n.s.	n.s.
	ATO	n.s.	~ZT2	n.s.	n.s.
DG	SAL	n.s.	n.s.	n.s.	n.s.
	MPD	n.s.	n.s.	n.s.	n.s.
	ATO	n.s.	n.s.	n.s.	~ZT2
BLA	SAL	n.s.	n.s.	n.s.	n.s.
	MPD	n.s.	n.s.	n.s.	n.s.
	ATO	~ZT2	n.s.	n.s.	n.s.
CEA	SAL	n.s.	n.s.	n.s.	n.s.
	MPD	n.s.	n.s.	n.s.	n.s.
	ATO	n.s.	n.s.	~ZT20	n.s.

Table 4.2. Co-sinor analysis of immunoreactivity of CLOCK, PER1, PER2 and c-Fos in the limbic forebrain of each treatment group; saline (SAL), methylphenidate (MPD) and atomoxetine (ATO). n.s = not significantly rhythmic.

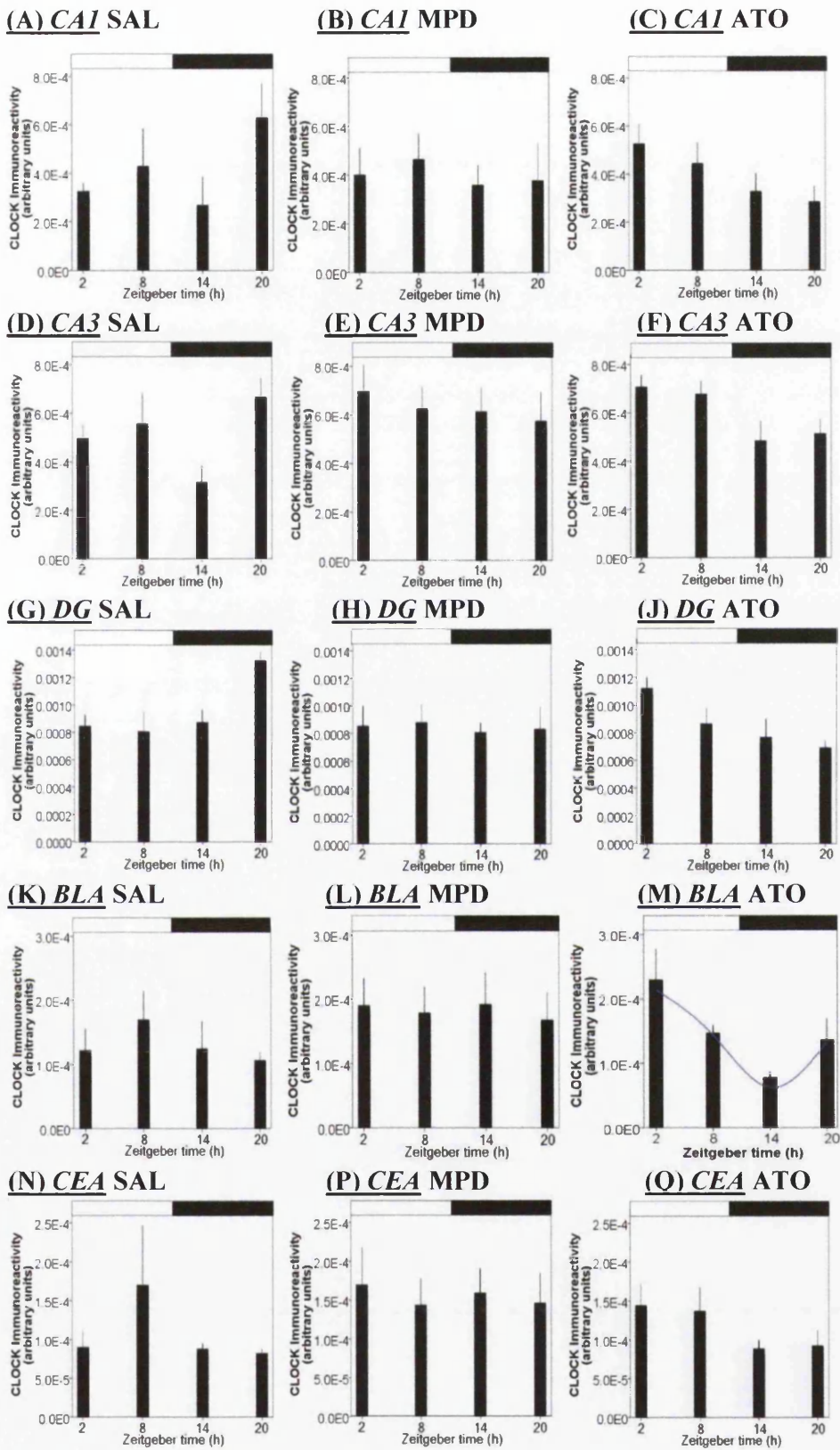

Figure 4.10. CLOCK immunoreactivity measured by immunoreactive cell counts in the CA1, CA3, DG, BLA and CEA of mice that underwent chronic treatment of

either a saline control (SAL), methylphenidate (MPD) or atomoxetine (ATO). Presence of a fitted curve indicates a significant rhythm as assessed by co-sinor analysis.

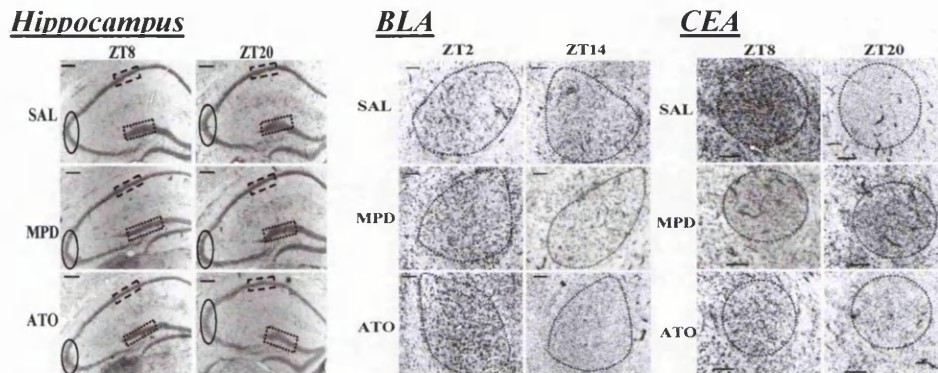

Figure 4.11. Photomicrographs of CLOCK immunostaining in the hippocampus (dashed box = CA1, solid ellipse = CA3, dotted box = DG, scale bars = 200µm) and in the CEA during the mid subjective day (ZT8) and mid subjective night (ZT20) and in the BLA during the early subjective day (ZT2) and early subjective night (ZT14) of mice that underwent chronic treatment of either methylphenidate (MPD), atomoxetine (ATO) or a saline control (SAL). (Scale bars =100µm for BLA and CEA).

PER1 expression in the limbic forebrain

PER1 expression was rhythmic in the CA1 and CA3 regions of the saline control mice, with acrophases at ZT2 in both cases (figures 4.12A and 4.12D, table 4.2), although PER1 expression in the DG, BLA and CEA was not significantly rhythmic in these mice (figures 4.12G, 4.12K, 4.12N, table 4.2). PER1 expression in the DG, BLA and CEA regions of both the methylphenidate and atomoxetine treated mice did not exhibit rhythmicity, which is unaltered from the non-rhythmic PER1 expression in these regions in the saline control (figures 4.12H-J, 4.12L-M, 4.12P-Q, table 4.2). PER1 expression in the CA1 and CA3 regions of atomoxetine treated mice, was significantly rhythmic with an acrophase at ZT2 in each case, and was thus unaltered from the saline control (figures 4.12C, 4.12F, table 4.2). However, the methylphenidate treated mice exhibited a loss of rhythmic PER1 expression in both of these regions (figures 4.12B, 4.12E, table 4.2). There was a significant main effect of time upon PER1 expression in the CA1, CA3 and BLA regions ($df=3$, $F=10.445$,

$P < 0.001$; $df=3$, $F=8.253$, $P < 0.001$; $df=3$, $F=3.745$, $P < 0.05$ respectively), but not upon PER1 expression in the DG and CEA regions. However, no significant main effects of treatment or interactions of time and treatment were observed upon PER1 expression in any of the regions of the limbic forebrain examined.

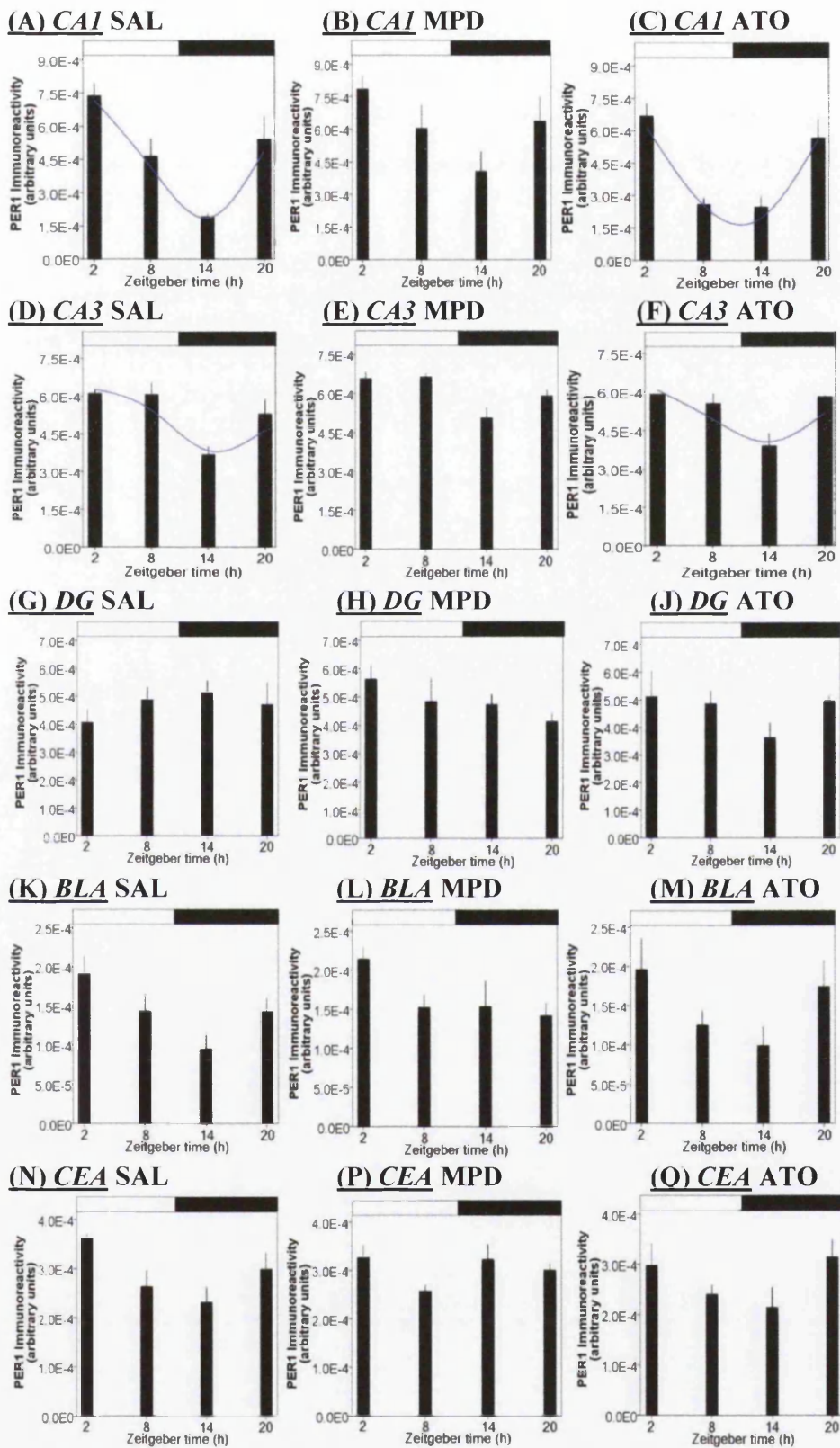

Figure 4.12. PER1 immunoreactivity measured by immunoreactive cell counts in the CA1, CA3, DG, BLA and CEA of mice that underwent chronic treatment of either a

saline control (SAL), methylphenidate (MPD) or atomoxetine (ATO). Presence of a fitted curve indicates a significant rhythm as assessed by co-sinor analysis.

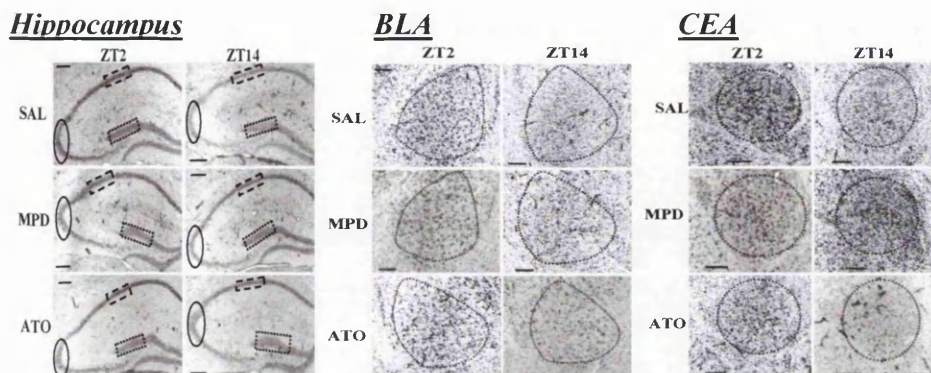

Figure 4.13. Photomicrographs of PER1 immunostaining in the hippocampus (dashed box = CA1, solid ellipse = CA3, dotted box = DG, scale bars = 200 μ m) and in the BLA and CEA during the early subjective day (ZT2) and early subjective night (ZT14) of mice that underwent chronic treatment of either methylphenidate (MPD), atomoxetine (ATO) or a saline control (SAL). (Scale bars =100 μ m for BLA and CEA).

PER2 expression in the limbic forebrain

PER2 expression was not rhythmic in any of the limbic forebrain regions examined of the saline control mice and the methylphenidate treated mice (figures 4.14A-B, 4.14D-E, 4.14G-H, 4.14K-L, 4.14N-P, table 4.2). However, PER2 expression was significantly rhythmic in the CA1 and CEA regions of the atomoxetine treated mice, with acrophases of ZT2 and ZT20 respectively (figures 4.14C, 4.14Q, table 4.2), whilst PER2 expression did not exhibit a significant rhythm in CA3, DG and BLA regions of the atomoxetine treated mice (figures 4.14F, 4.14J, 4.14M, table 4.2). There was no significant main effect of treatment or interaction of time and treatment upon PER2 expression in any of the regions of the limbic forebrain examined. There was a significant main effect of time upon PER2 expression in the CA1 and CEA regions ($df=3$, $F=4.587$, $P<0.01$, and $df=3$, $F=3.829$, $P<0.05$ respectively), but not in the CA3, DG and BLA regions.

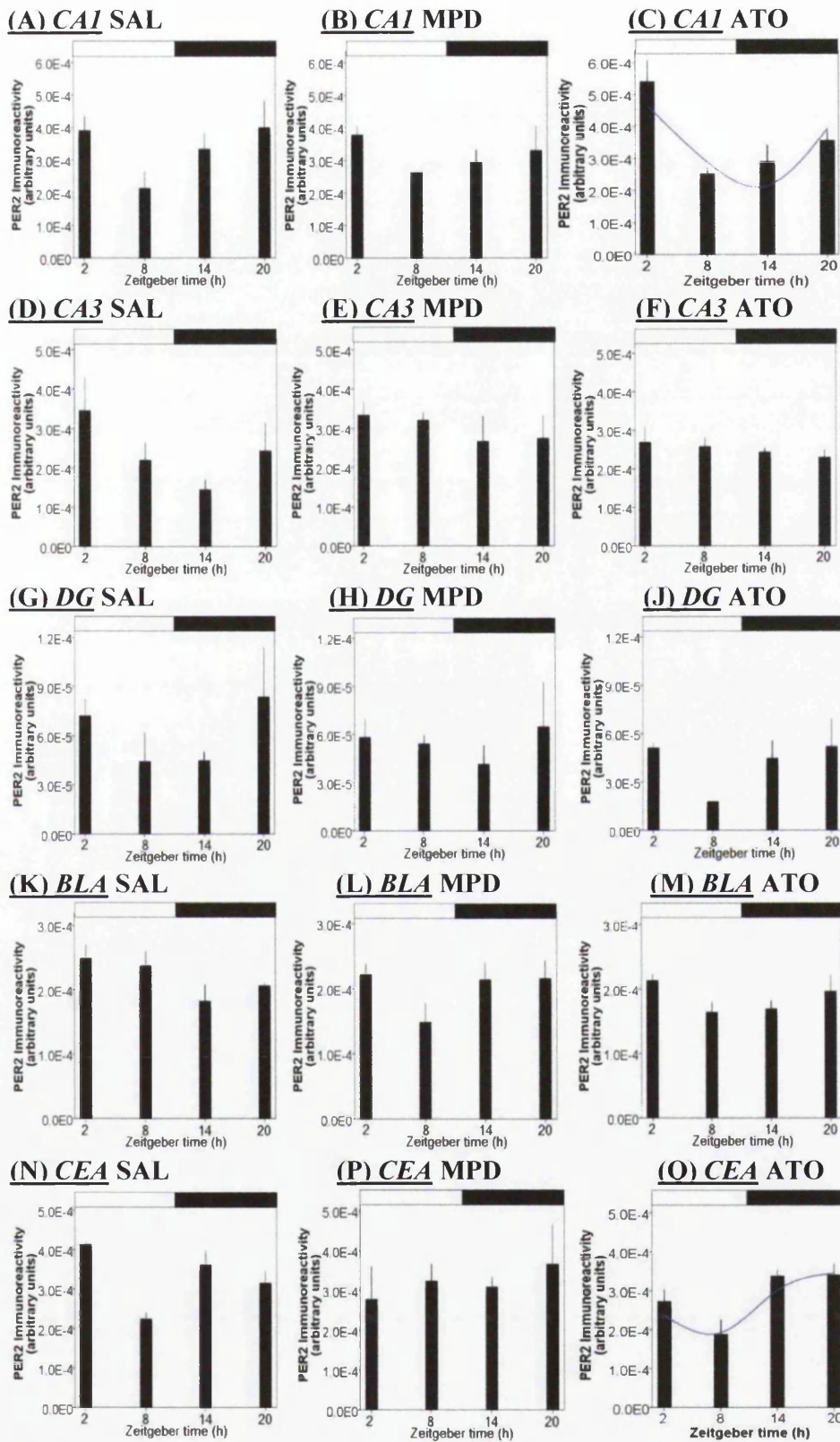

Figure 4.14. PER2 immunoreactivity measured by immunoreactive cell counts in the CA1, CA3, DG, BLA and CEA of mice that underwent chronic treatment of either a

saline control (SAL), methylphenidate (MPD) or atomoxetine (ATO). Presence of a fitted curve indicates a significant rhythm as assessed by co-sinor analysis.

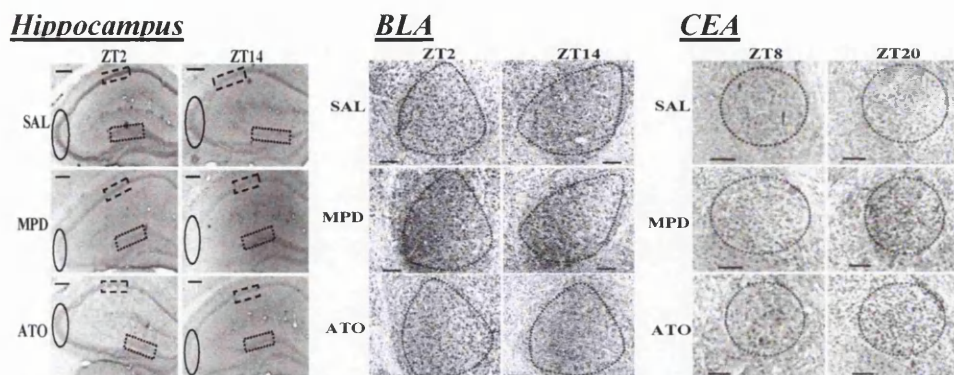

Figure 4.15. Photomicrographs of PER2 immunostaining in the hippocampus (dashed box = CA1, solid ellipse = CA3, dotted box = DG, scale bars = 200µm) and in the BLA during the early subjective day (ZT2) and early subjective night (ZT14) and in the CEA during the mid subjective day (ZT8) and mid subjective night (ZT20) of mice that underwent chronic treatment of either methylphenidate (MPD), atomoxetine (ATO) or a saline control (SAL). (Scale bars =100µm for BLA and CEA).

c-Fos expression in the limbic forebrain

c-Fos expression was not rhythmic in any of the regions of the limbic forebrain examined in the saline control mice (figures 4.16A, 4.16D, 4.16G, 4.16K, 4.16N, table 4.2). c-Fos expression was also not significantly rhythmic in the CA3, BLA and CEA regions of both the atomoxetine and methylphenidate treated mice (figures 4.16E-F, 4.16L-M, 4.16P-Q, table 4.2). However, there was a significant main effect of treatment upon c-Fos expression in the BLA ($df=2$, $F=12.987$, $P<0.001$), the CEA ($df=2$, $F=8.213$, $P<0.01$) and in the CA3 ($df=2$, $F=34.325$, $P<0.001$), with *Post-hoc* testing revealing a significant increase in c-Fos expression in the BLA and CA3 regions of the methylphenidate treated mice in comparison to that of the atomoxetine treated mice and the saline control (all $P<0.001$), c-Fos expression was also increased in the CEA of the methylphenidate treated mice in comparison to that of the saline control ($P<0.01$). There was a significant main effect of time upon c-Fos expression in the CA3 region ($df=3$, $F=5.734$, $P<0.01$), but not the CEA and BLA regions, and

there was no significant interaction of time and treatment upon c-Fos expression in the CA3, BLA and CEA regions.

The methylphenidate treated mice exhibited rhythmic c-Fos expression in the CA1 region, with an acrophase at ZT2, which is in contrast to the non-rhythmic expression exhibited by the saline control and atomoxetine treated mice (figures 4.16A-C, table 4.2). A significant main effect of both time and treatment upon c-Fos expression in the CA1 region was demonstrated ($df=3$, $F=15.482$, $P<0.001$ and $df=2$, $F=35.465$, $P<0.001$ respectively), in addition to a significant interaction of time and treatment ($df=6$, $F=10.475$, $P<0.001$). *Post-hoc* analysis revealed c-Fos expression in the CA1 region of mice who had undergone methylphenidate treatment was significantly greater than that of both the atomoxetine treated mice and the saline control (both $P<0.001$). c-Fos was expressed with a significant rhythm in the DG region of the atomoxetine treated mice, with an acrophase of ZT2, whereas its expression was not rhythmic in the same region of the methylphenidate treated mice or the saline control (figures 4.16G-J, table 4.2). There was a significant main effect of both time and treatment upon c-Fos expression in the DG ($df=3$, $F=8.957$, $P<0.001$ and $df=2$, $F=23.823$, $P<0.001$ respectively), with *post-hoc* testing revealing an increase in c-Fos expression in the DG of both methylphenidate and atomoxetine treated mice in comparison to the saline control ($P<0.001$, $P<0.05$ respectively). Furthermore, c-Fos expression in the DG was increased in the methylphenidate treated mice in comparison to the mice that had undergone atomoxetine treatment ($P<0.01$). There was however no significant interaction of time and treatment upon c-Fos expression in the DG.

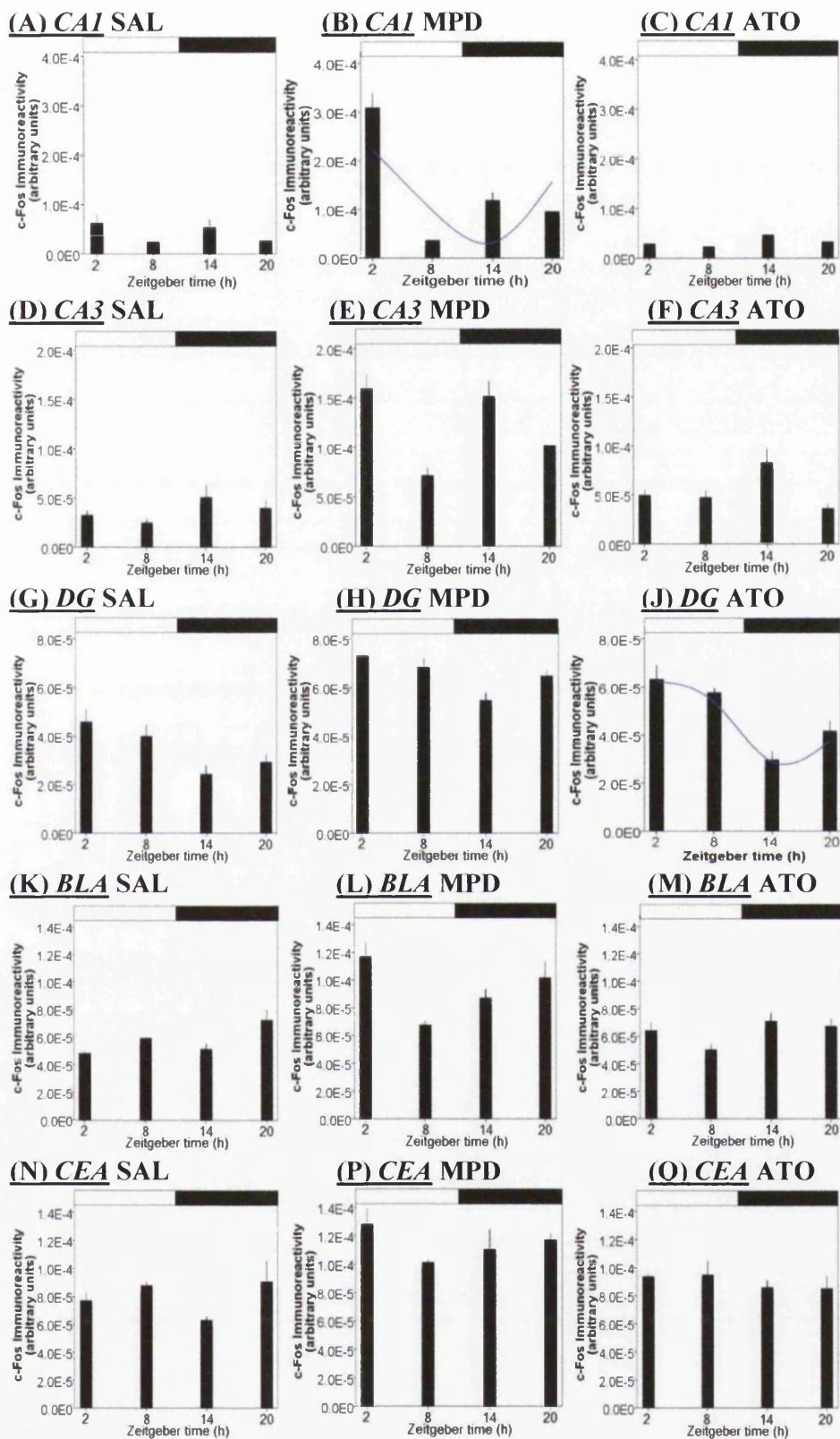

Figure 4.16. c-Fos immunoreactivity measured by immunoreactive cell counts in the CA1, CA3, DG, BLA and CEA of mice that underwent chronic treatment of either a

saline control (SAL), methylphenidate (MPD) or atomoxetine (ATO). Presence of a fitted curve indicates a significant rhythm as assessed by co-sinor analysis.

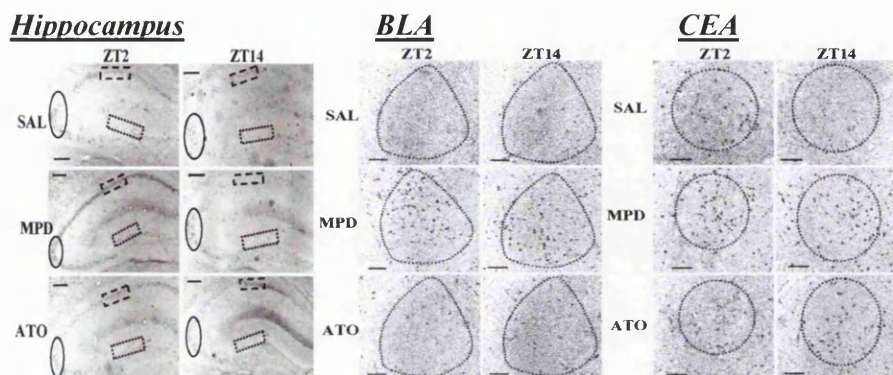

Figure 4.17. Photomicrographs of c-Fos immunostaining in the hippocampus (dashed box = CA1, solid ellipse = CA3, dotted box = DG, scale bars = 200 μ m) and in the BLA and CEA during the early subjective day (ZT2) and early subjective night (ZT14) of mice that underwent chronic treatment of either methylphenidate (MPD), atomoxetine (ATO) or a saline control (SAL). (Scale bars =100 μ m for BLA and CEA).

4.3.3 Circadian clock protein expression in the cerebral cortex

Clock expression in the cerebral cortex

CLOCK was expressed without significant rhythmicity in the CC, PLC and ILC of the saline control mice and the methylphenidate treatment group (figures 4.18A-B, 4.18D-E, 4.18G-H, 4.19, table 4.3). Whilst CLOCK was expressed without significant rhythmicity in the PLC and ILC of the atomoxetine treatment group (figures 4.18F, 4.18J, 4.19, table 4.3), there was a significant rhythm of CLOCK expression with an acrophase at ZT2 in the CC of the atomoxetine treatment group (figures 4.18C, 4.19, table 4.3). There was however no significant effects of time, treatment, or interaction of time and treatment upon CLOCK expression in the PLC or ILC, and in the CC.

Brain region	Treatment	Acrophase of Immunoreactivity (h)			
		CLOCK	PER1	PER2	c-Fos
CC	SAL	n.s.	n.s.	n.s.	n.s.
	MPD	n.s.	n.s.	n.s.	n.s.
	ATO	~ZT2	n.s.	n.s.	n.s.
PLC	SAL	n.s.	n.s.	n.s.	n.s.
	MPD	n.s.	n.s.	n.s.	n.s.
	ATO	n.s.	n.s.	n.s.	n.s.
ILC	SAL	n.s.	n.s.	n.s.	n.s.
	MPD	n.s.	n.s.	n.s.	n.s.
	ATO	n.s.	n.s.	n.s.	~ZT18

Table 4.3. Acrophases of rhythmic immunoreactivity of CLOCK, PER1, PER2 and c-Fos in the cerebral cortex of each treatment group; saline (SAL), methylphenidate (MPD) and atomoxetine (ATO), assessed by co-sinor analysis. n.s = not significantly rhythmic.

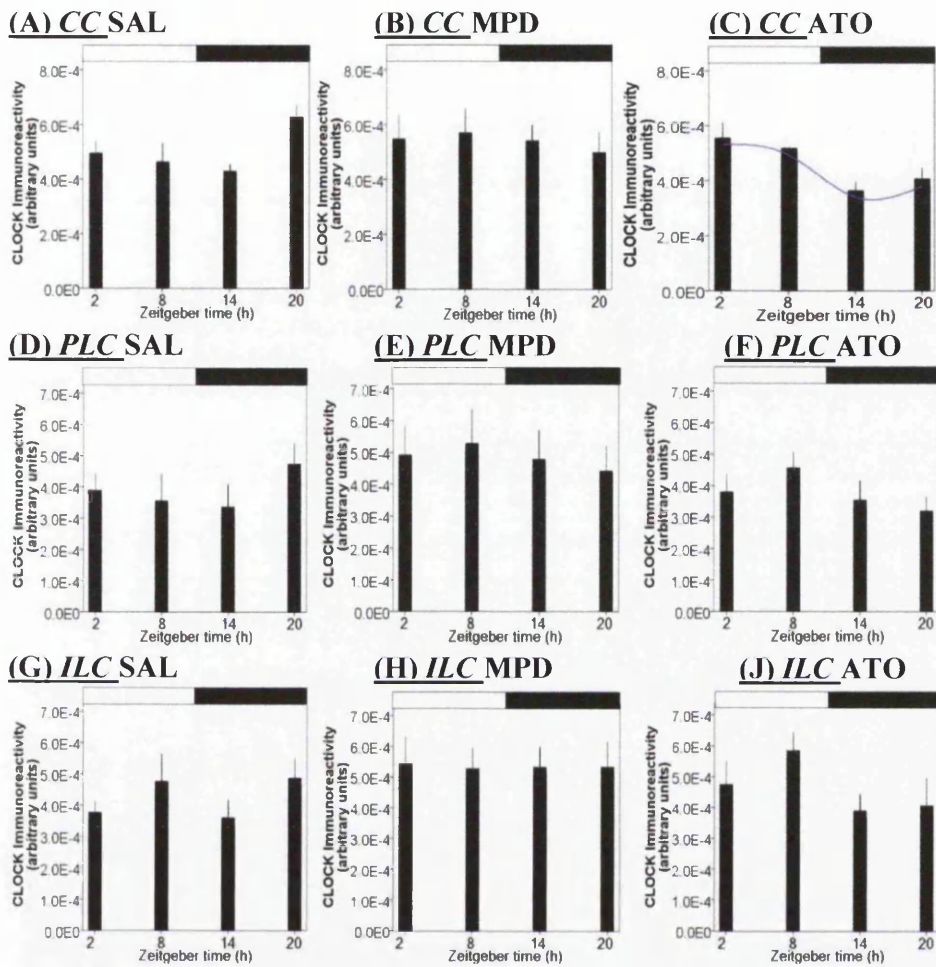

Figure 4.18. CLOCK immunoreactivity measured by immunoreactive cell counts in the CC, PLC and ILC of mice chronically treated with either saline control (SAL), methylphenidate (MPD) or atomoxetine (ATO). A fitted curve indicates a significant rhythm assessed by co-sinor analysis.

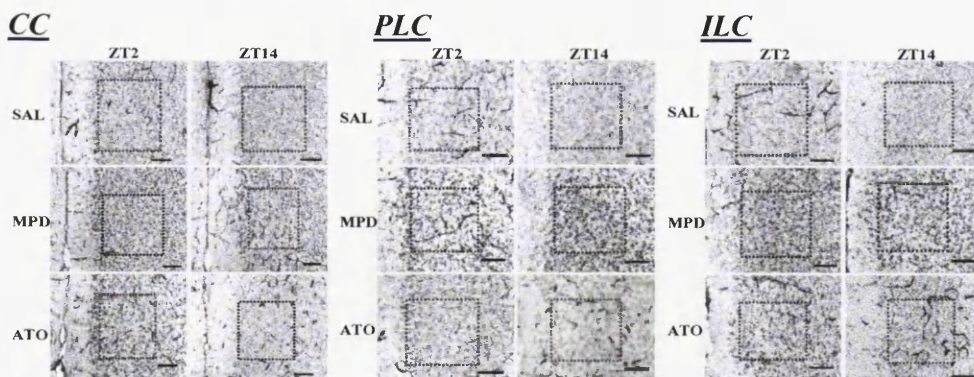

Figure 4.19. Photomicrographs of CLOCK immunostaining in the CC, PLC and ILC of mice that underwent chronic treatment of either methylphenidate (MPD), atomoxetine (ATO) or a saline control (SAL) during the early subjective day (ZT2) and early subjective night (ZT14). Scale bars = 100µm.

Per1 expression in the cerebral cortex

PER1 was expressed in the CC, PLC and ILC of the saline control mice and in the methylphenidate and atomoxetine treatment groups (figure 4.21), without significant rhythmicity in each case (figures 4.20A-J, table 4.3). There was also no significant main effect of treatment or interaction of time and treatment upon PER1 expression in either of these regions. There was however a significant main effect of time upon PER1 expression in the CC ($df=3, F=3.364, P<0.05$), whilst there was no significant effect of time upon PER1 expression in the PLC and ILC.

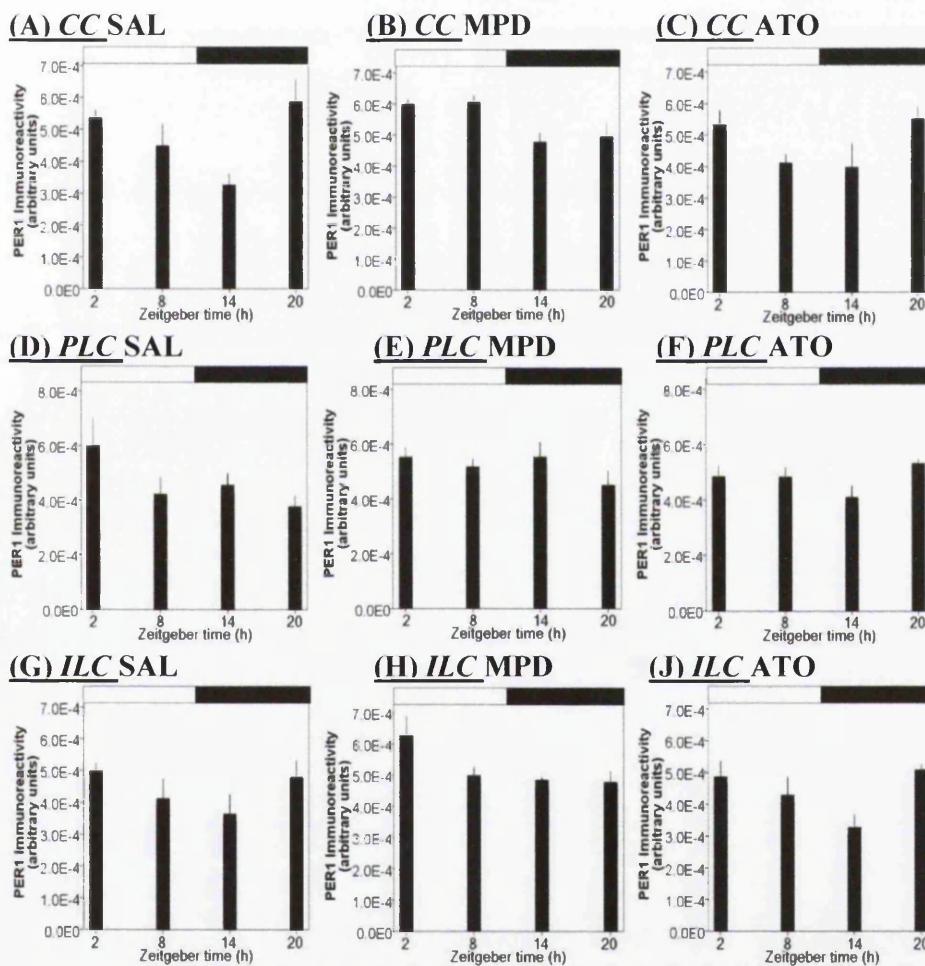

Figure 4.20. PER1 immunoreactivity measured by immunoreactive cell counts in the CC, PLC and ILC of mice chronically treated with either saline control (SAL), methylphenidate (MPD) or atomoxetine (ATO). A fitted curve indicates a significant rhythm as assessed by co-sinor analysis.

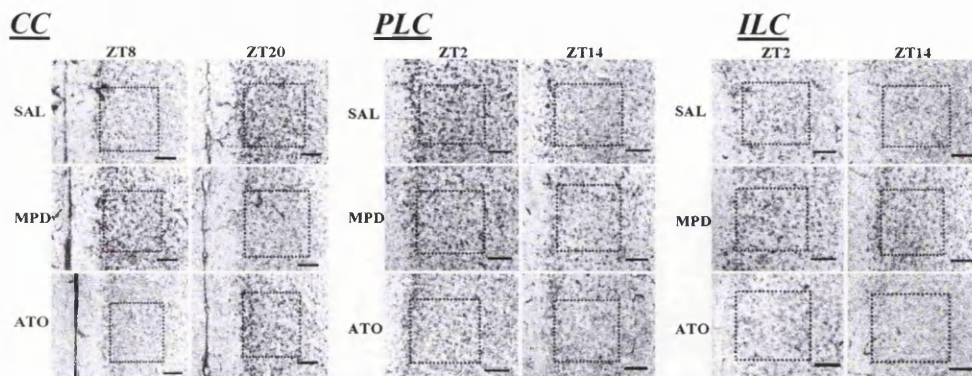

Figure 4.21. Photomicrographs of PER1 immunostaining in the CC during the mid subjective day (ZT8) and mid subjective night (ZT20) and in the PLC and ILC during the early subjective day (ZT2) and early subjective night (ZT14) of mice that underwent chronic treatment of either methylphenidate (MPD), atomoxetine (ATO) or a saline control (SAL). Scale bars = 100 μ m.

Per2 expression in the cerebral cortex

Whilst PER2 was expressed in all regions of the cerebral cortex examined in all three treatment groups (figure 4.23), it was not significantly rhythmic in any of these cases (figures 4.22A-J, table 4.3). There was also no significant main effect of treatment or interaction of time and treatment upon PER2 expression in any of these brain regions. A significant main effect of time upon PER2 expression in the CC was observed ($df=3$, $F=3.721$, $P<0.05$), whilst there was no effect of time upon PER2 expression in the PLC and ILC.

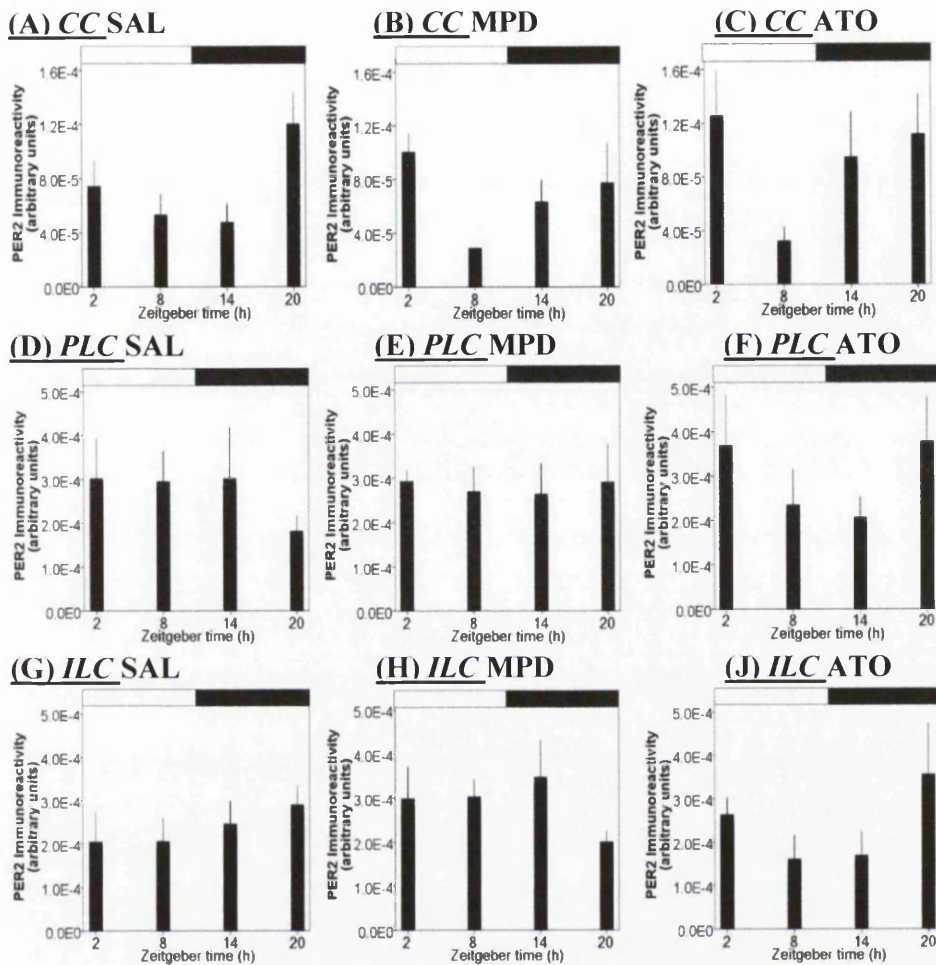

Figure 4.22. PER2 immunoreactivity measured by immunoreactive cell counts in the CC, PLC and ILC of mice chronically treated with either saline control (SAL), methylphenidate (MPD) or atomoxetine (ATO). A fitted curve indicates a significant rhythm as assessed by co-sinor analysis.

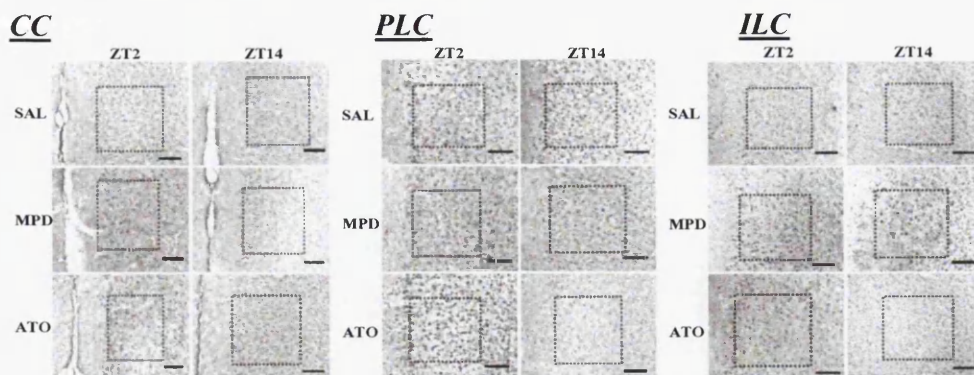

Figure 4.23. Photomicrographs of PER2 immunostaining in the CC, PLC and ILC of mice that underwent chronic treatment of either methylphenidate (MPD), atomoxetine (ATO) or a saline control (SAL) during the early subjective day (ZT2) and early subjective night (ZT14). Scale bars = 100µm.

c-Fos expression in the cerebral cortex

c-Fos was expressed in all three regions examined of the cerebral cortex in all three treatment groups (figure 4.25) and this was without rhythmicity in these regions of the methylphenidate treatment group and the saline control (figures 4.24A-B, 4.24D-E, 4.24G-H, table 4.3). c-Fos was not rhythmically expressed in the CC and PLC of the atomoxetine treatment group (figures 4.24C, 4.24F, table 4.3), however there was a significant rhythm of c-Fos expression in the ILC of these mice with an acrophase at ~ZT18 (figure 4.24J, table 4.3). A significant main effect of treatment upon c-Fos expression in the PLC and ILC ($df=2$, $F=18.925$, $P>0.001$; $df=2$, $F=19.029$, $P<0.001$ respectively) and in the CC was shown ($df=2$, $F=17.643$, $P<0.001$). *Post-hoc* analysis revealed significantly greater c-Fos expression in the CC, PLC and ILC of the methylphenidate treatment group in comparison to both the atomoxetine treatment group and the saline control (all $P<0.001$). A significant effect of time upon c-Fos expression was also observed in the CC ($df=3$, $F=12.456$, $P<0.001$), PLC ($df=3$, $F=5.675$, $P<0.01$) and ILC ($df=3$, $F=8.027$, $P<0.001$). There was no significant interaction of time and treatment in any of the regions examined.

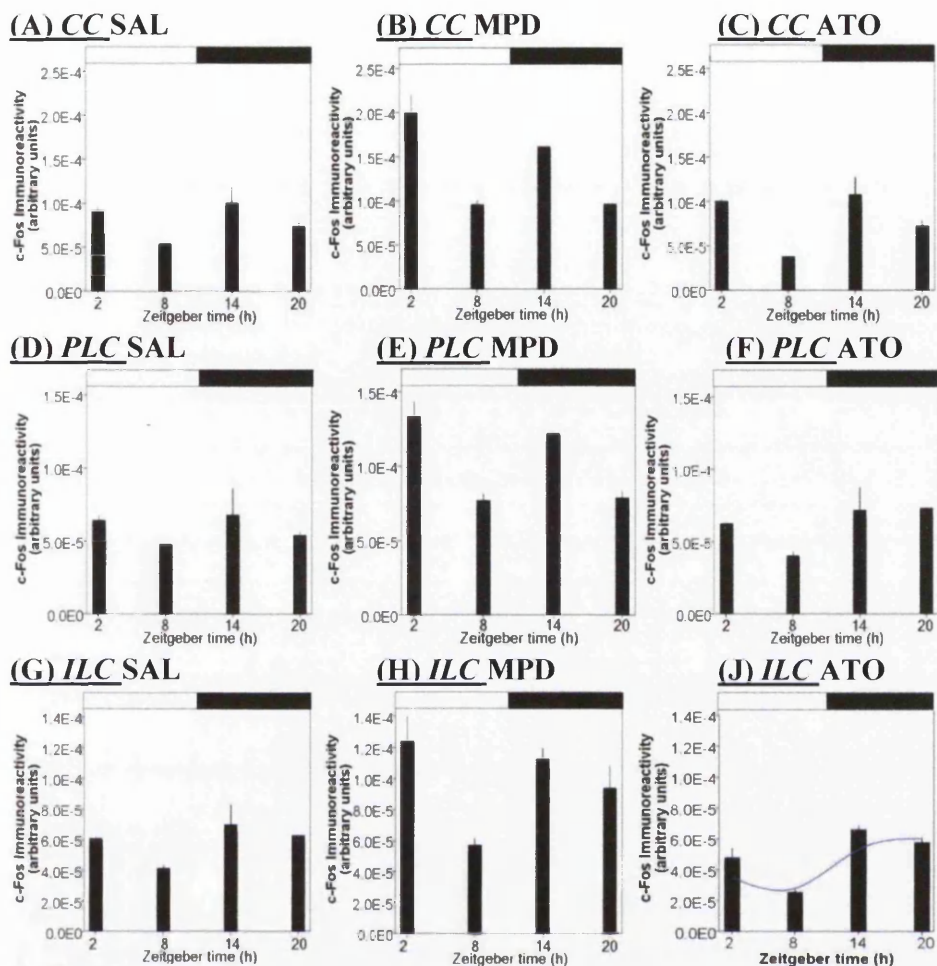

Figure 4.24. c-Fos immunoreactivity measured by immunoreactive cell counts in the CC, PLC and ILC of mice chronically treated with either saline control (SAL), methylphenidate (MPD) or atomoxetine (ATO). A fitted curve indicates a significant rhythm as assessed by co-sinor analysis.

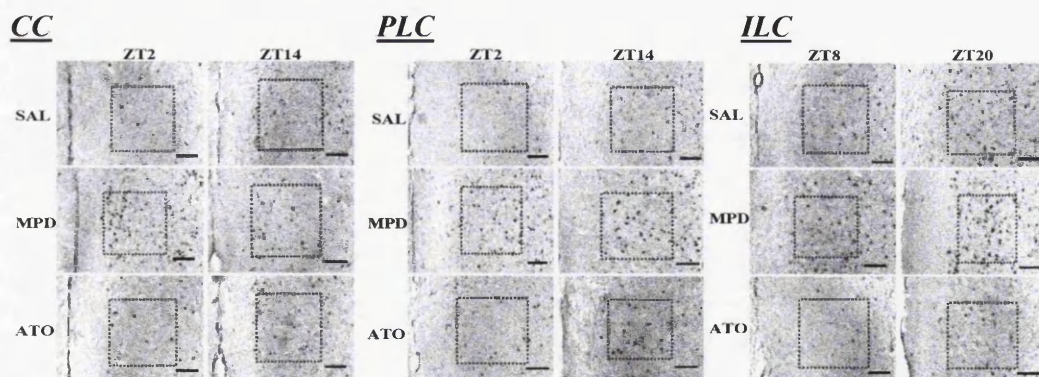

Figure 4.25. Photomicrographs of c-Fos immunostaining in the CC and PLC (early subjective day (ZT2) and early subjective night (ZT14) and in the ILC (mid subjective day (ZT8) and mid subjective night (ZT20) of mice chronically treated with MPD, ATO or a saline control (SAL). Scale bars = 100 μ m.

4.3.4 Circadian clock protein expression in the striatum

CLOCK expression in the striatum

CLOCK was expressed in all three regions of the striatum examined; CPu, nucleus accumbens core (AcbC) and nucleus accumbens shell (AcbSh), in the saline control mice and in both the atomoxetine and methylphenidate treated mice (figure 4.27). The expression of CLOCK in the saline control mice was significantly rhythmic in the CPu with an acrophase at ZT20 (figure 4.26A, table 4.4), but did not exhibit rhythmicity in either AcbC or AcbSh (figures 4.26D, 4.26G, table 4.4). CLOCK expression was also rhythmic in the CPu of the methylphenidate and atomoxetine treated mice, but with an acrophase at ZT2 and ~ ZT5 respectively (figures 4.26B-C, table 4.4). CLOCK did not exhibit rhythmic expression in either the AcbC or AcbSh regions of the methylphenidate and atomoxetine treated mice, similarly to the saline control (figures 4.26E-F, 4.26H-J, table 4.4). No significant main effect of treatment upon CLOCK expression in the CPu, AcbC or AcbSh were detected, and there was no significant effect of time upon CLOCK expression in the AcbC and AcbSh, whilst there was a significant effect of time upon CLOCK expression in the CPu ($df=3$, $F=6.759$, $P<0.01$). A significant interaction of time and treatment upon CLOCK expression was also detected in the CPu ($df=6$, $F=2.816$, $P<0.05$), but not in the AcbC and AcbSh.

Brain region	Treatment	Acrophase of Immunoreactivity (h)			
		CLOCK	PER1	PER2	c-Fos
CPu	SAL	~ZT20	~ZT2	~ZT2	n.s.
	MPD	~ZT2	~ZT2	~ZT14	n.s.
	ATO	~ZT5	~ZT2	~ZT2	n.s.
AcbC	SAL	n.s.	n.s.	n.s.	n.s.
	MPD	n.s.	n.s.	n.s.	n.s.
	ATO	n.s.	n.s.	n.s.	n.s.
AcbSh	SAL	n.s.	n.s.	n.s.	n.s.
	MPD	n.s.	n.s.	~ZT20	n.s.
	ATO	n.s.	n.s.	n.s.	n.s.

Table 4.4. Acrophases of rhythmic immunoreactivity of CLOCK, PER1, PER2 and c-Fos in the striatum of each treatment group; saline (SAL), methylphenidate (MPD) and atomoxetine (ATO), assessed by co-sinor analysis. n.s.=not significantly rhythmic.

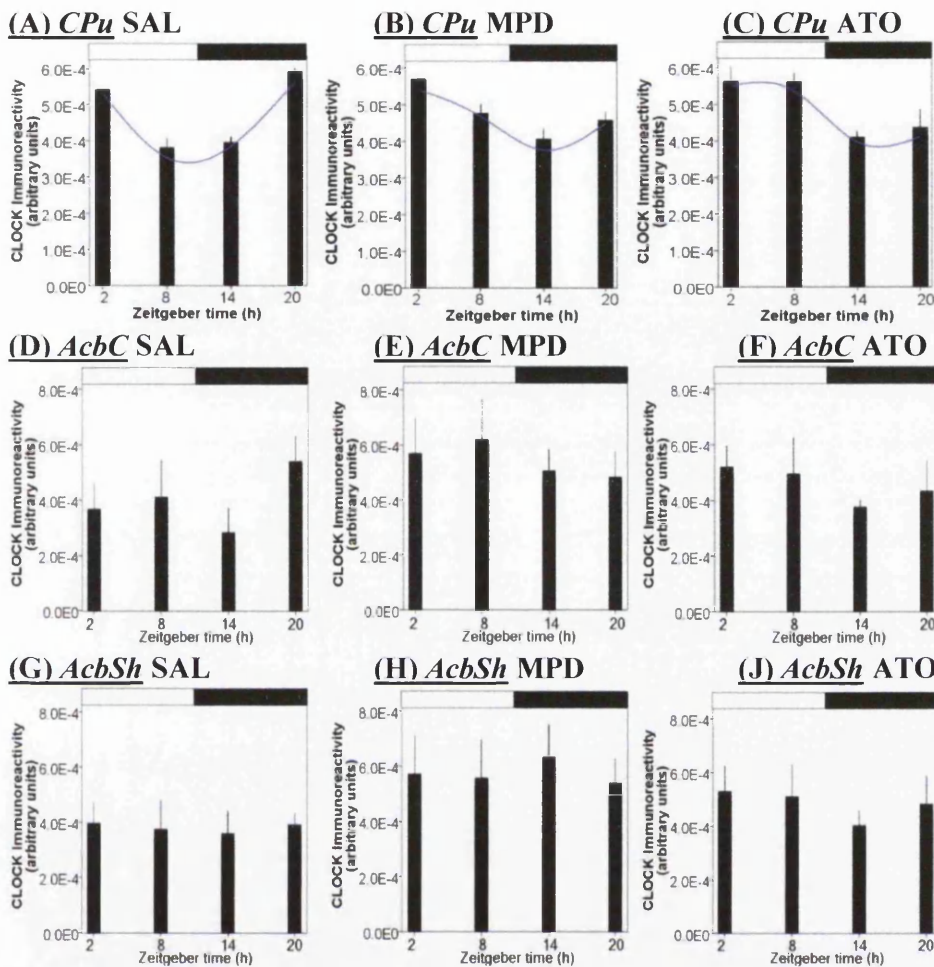

Figure 4.26. CLOCK immunoreactivity measured by immunoreactive cell counts in the CPu, AcbC and AcbSh of mice chronically treated with saline control (SAL), MPD or ATO. A fitted curve = significant rhythm as assessed by co-sinor analysis.

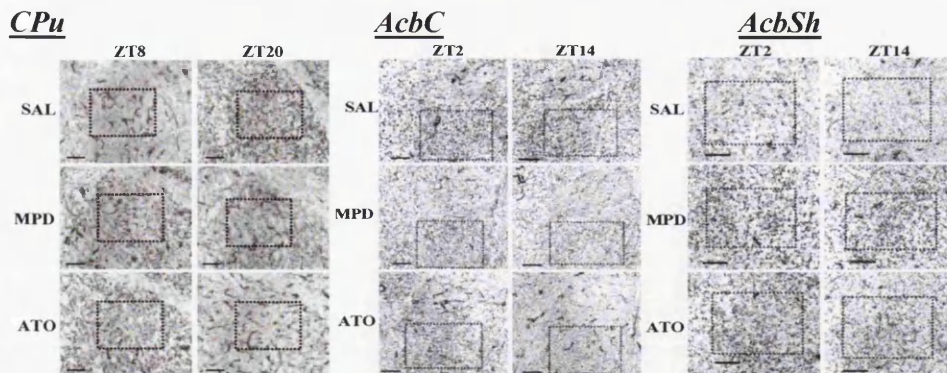

Figure 4.27. Photomicrographs of CLOCK immunostaining measured by immunoreactive cell counts in the CPu (mid subjective day (ZT8) and mid subjective night (ZT20) and in the AcbC and AcbSh (early subjective day (ZT2) and early subjective night (ZT14) of mice that underwent chronic treatment of MPD, ATO or a saline control (SAL) Scale bars = 100 μ m.

PER1 expression in the striatum

PER1 expression was rhythmic in the CPu of all treatment groups, with an acrophase at ZT2 in each case (figures 4.28A-C, table 4.4). No significant effect of treatment upon PER1 expression in the CPu was detected, although there was a significant effect of time upon PER1 expression in the CPu ($df=3$, $F=4.399$, $P<0.01$), and a significant interaction of time and treatment ($df=6$, $F=2.813$, $P<0.05$).

PER1 expression was not rhythmic in either the AcbC or AcbSh regions of all three treatment groups (figures 4.28D-J, table 4.4), although a significant main effect of treatment upon PER1 expression in the AcbC and AcbSh was detected ($df=2$, $F=3.915$, $P<0.05$ and $df=2$, $F=3.651$, $P<0.05$ respectively). *Post-hoc* analysis revealed a significant increase in PER1 expression in the AcbC of the methylphenidate treatment group compared to the atomoxetine treatment group ($P<0.05$) and significantly greater PER1 expression in the AcbSh of the methylphenidate treatment group compared to the saline control ($P<0.05$). There was however no significant main effects of time or interaction of time and treatment upon PER1 expression in the AcbC and AcbSh.

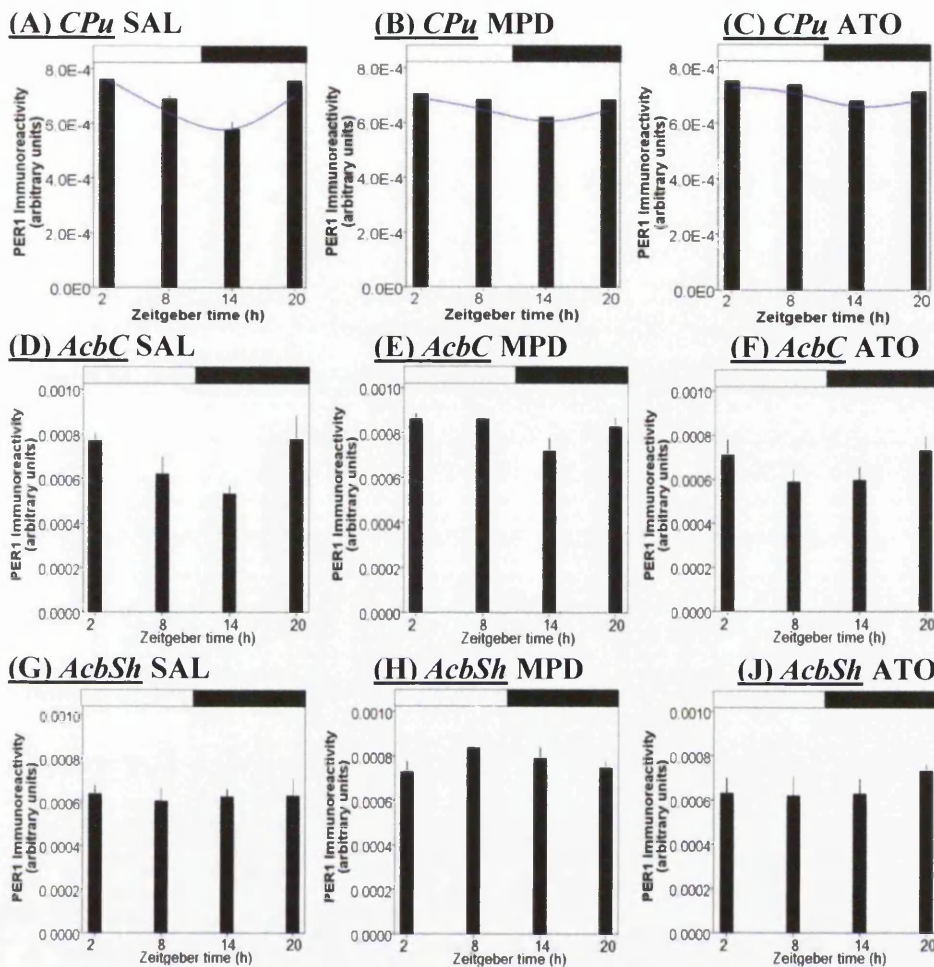

Figure 4.28. PER1 immunoreactivity measured by immunoreactive cell counts in the CPu, AcbC and AcbSh of mice chronically treated with either saline control (SAL), methylphenidate (MPD) or atomoxetine (ATO). A fitted curve indicates a significant rhythm assessed by co-sinor analysis.

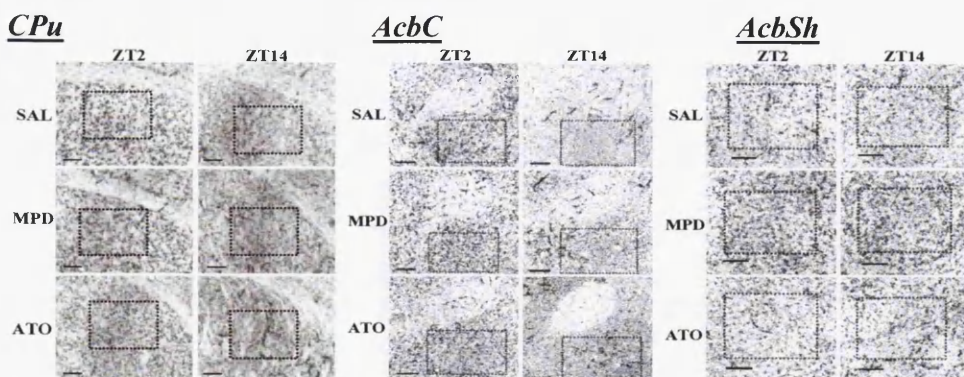

Figure 4.29. Photomicrographs of PER1 immunostaining measured by immunoreactive cell counts in the CPu, AcbC and AcbSh of mice that underwent chronic treatment of MPD, ATO or a saline control (SAL) during the early subjective day (ZT2) and early subjective night (ZT14). Scale bars = 100 μ m.

PER2 expression in the striatum

PER2 expression was not rhythmic in the AcbC and AcbSh regions in the saline control mice (figures 4.30D, 4.30G, table 4.4), whereas PER2 expression was rhythmic in the CPu of these mice, with an acrophase at ZT2 (figure 4.30A table 4.4). PER2 expression was also not rhythmic in the AcbC regions of the methylphenidate and atomoxetine treated mice and in the AcbSh region of the atomoxetine treated mice (figures 4.30E-F, 4.30J, table 4.4), although rhythmic expression of PER2 was demonstrated in the AcbSh of methylphenidate treated mice, with an acrophase at ZT20 (figure 4.30H, table 4.4). The phase of PER2 expression in the CPu of atomoxetine treated mice was unaltered from the saline control, with peak expression at ZT2 (figure 4.30C, table 4.4), whereas PER2 expression in the CPu of the methylphenidate treated mice was phase reversed with an acrophase at ZT14 (figure 4.30B, table 4.4).

A significant main effect of treatment upon PER2 expression in the CPu was shown ($df=2$, $F=31.512$, $P<0.001$) and *post-hoc* analysis demonstrated that PER2 expression in the CPu of mice that had undergone both methylphenidate and atomoxetine treatments was elevated in comparison to that of the saline control ($P<0.001$). Furthermore, PER2 expression was increased in the CPu of methylphenidate treated mice in comparison to the atomoxetine treated mice ($P<0.01$). There was also a significant effect of time ($df=3$, $F=2.874$, $P<0.05$) and a significant interaction of time and treatment ($df=6$, $F=5.944$, $P<0.001$) upon PER2 expression in the CPu.

Significant main effects of both time and treatment upon PER2 expression were also demonstrated in the AcbC ($df=3$, $F=6.784$, $P<0.01$ and $df=2$, $F=6.618$, $P<0.01$ respectively), with a significant increase in PER2 expression in the atomoxetine treatment group compared to the saline control ($P<0.01$). There was no significant main effect of treatment or time upon PER2 expression in the AcbSh, and no significant interaction of time or treatment upon PER2 expression in the AcbC and AcbSh.

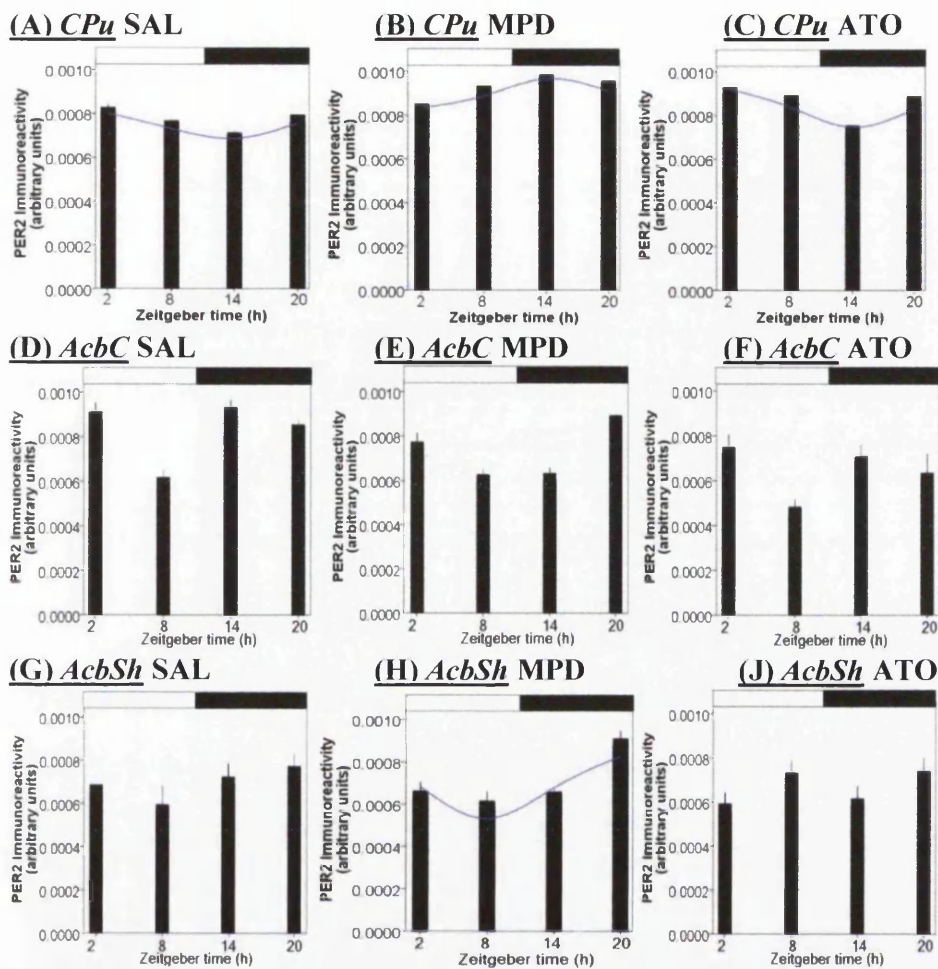

Figure 4.30. PER2 immunoreactivity measured by immunoreactive cell counts in the CPu, AcbC & AcbSh of mice chronically treated with saline control (SAL), MPD or ATO. A fitted curve indicates a significant rhythm assessed by co-sinor analysis.

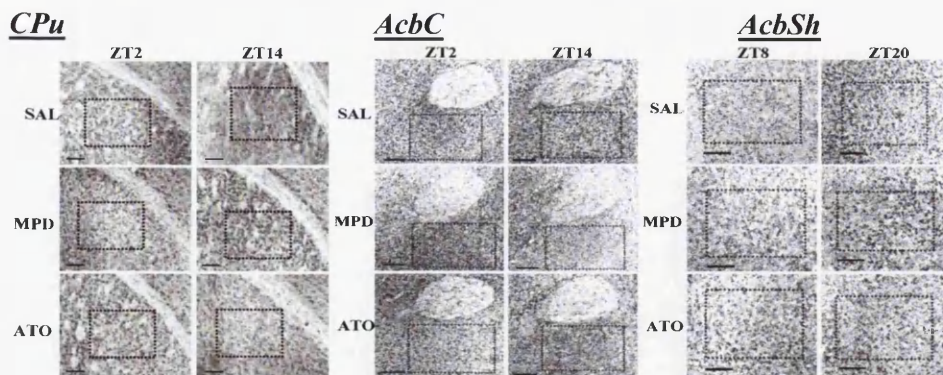

Figure 4.31. Photomicrographs of PER2 immunostaining in the CPu and AcbC during the early subjective day (ZT2) and early subjective night (ZT14) and in the AcbSh during the mid subjective day (ZT8) and mid subjective night (ZT20) of mice that underwent chronic treatment of MPD, ATO or a saline control (SAL). Scale bars = 100 μ m.

c-Fos expression in the striatum

c-Fos expression was not rhythmic in the AcbC, AcbSh and CPu regions of the saline control, methylphenidate and atomoxetine treated mice (figures 4.32A-J, table 4.4). However, ANOVA revealed significant main effects of both treatment and time upon c-Fos expression in the CPu ($df=2$, $F=47.708$, $P<0.001$ and $df=3$, $F=8.804$, $P<0.001$ respectively), and a significant interaction of time and treatment ($df=6$, $F=2.401$, $P<0.05$). *Post-hoc* testing showed an elevation of c-Fos expression in the CPu of both the methylphenidate and atomoxetine treated mice ($P<0.001$ and $P<0.01$ respectively) in comparison to the saline control. c-Fos expression was also greater in the CPu of the methylphenidate treated mice than the atomoxetine treatment group ($P<0.001$). There was also a significant main effect of treatment upon c-Fos expression in AcbC and AcbSh ($df=2$, $F=7.077$, $P<0.01$ and $df=2$, $F=11.223$, $P<0.001$), with *post-hoc* testing revealing a significant increase in c-Fos expression in the AcbC of the methylphenidate treatment group compared to the atomoxetine treatment group ($P<0.01$) and significantly increased expression of c-Fos in the AcbSh of the methylphenidate treated mice in comparison to the atomoxetine treated mice and the saline control ($P<0.001$ and $P<0.01$ respectively). There was also a significant main effect of time upon the expression of c-Fos in the AcbSh ($df=3$, $F=4.587$, $P<0.01$), but not in the AcbC, whilst there was no significant interaction of time and treatment in either region.

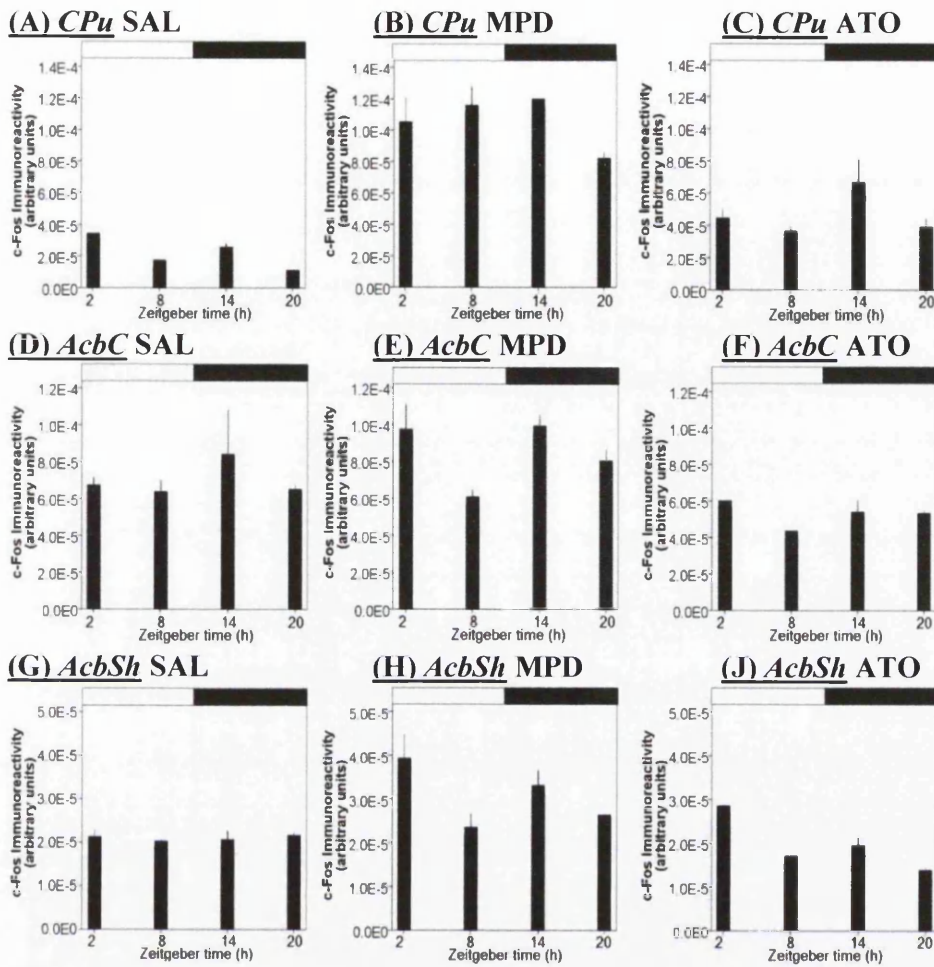

Figure 4.32. c-Fos immunoreactivity measured by immunoreactive cell counts in the CPu, AcbC and AcbSh of mice chronically treated with saline control (SAL), MPD or ATO. A fitted curve = significant rhythm, as assessed by co-sinor analysis.

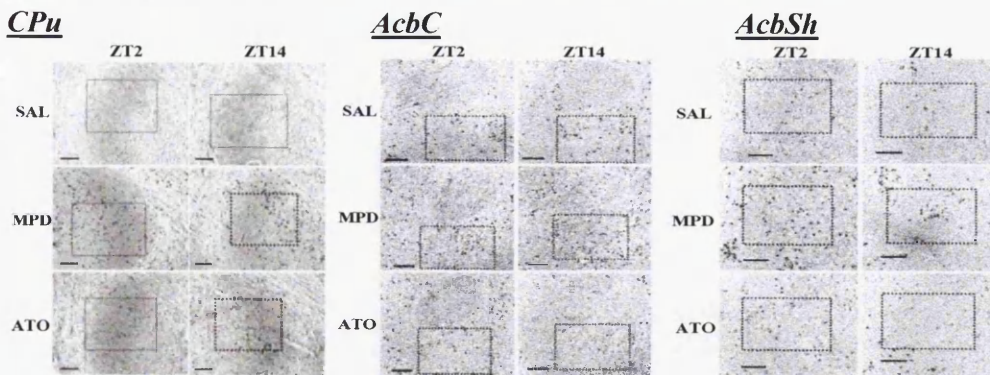

Figure 4.33. Photomicrographs of c-Fos immunostaining in the CPu, AcbC and AcbSh of mice that underwent chronic treatment of either methylphenidate (MPD), atomoxetine (ATO) or a saline control (SAL) during the early subjective day (ZT2) and early subjective night (ZT14). Scale bars = 100µm.

4.3.5 Circadian clock protein expression in the ventral tegmental area

CLOCK expression in the VTA

CLOCK was expressed in the VTA of all treatment groups without significant rhythmicity as assessed by co-sinor (figures. 4.34-4.35, table 4.5), and no significant main effects of time, treatment or interactions of time and treatment upon VTA CLOCK expression were detected.

Brain region	Treatment	Acrophase of Immunoreactivity (h)			
		CLOCK	PER1	PER2	c-Fos
VTA	SAL	n.s.	n.s.	~ZT14	~ZT20
	MPD	n.s.	n.s.	n.s.	~ZT20
	ATO	n.s.	n.s.	n.s.	n.s.

Table 4.5. Acrophases of rhythmic immunoreactivity of CLOCK, PER1, PER2 and c-Fos in the VTA of each treatment group; saline (SAL), methylphenidate (MPD) and atomoxetine (ATO), assessed by co-sinor analysis. n.s = not significantly rhythmic.

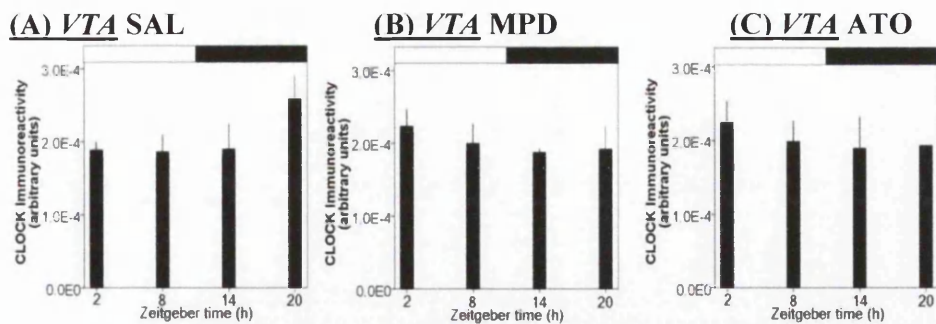

Figure 4.34. CLOCK immunoreactivity measured by immunoreactive cell counts in the VTA of mice that underwent chronic treatment of saline control (SAL), MPD or ATO. A fitted curve = significant rhythm, as assessed by co-sinor analysis.

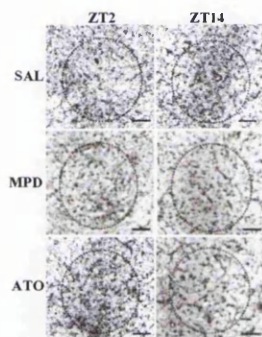

Figure 4.35. Photomicrographs of CLOCK immunostaining in the VTA of mice that underwent chronic treatment of either methylphenidate (MPD), atomoxetine (ATO) or a saline control (SAL) during the early subjective day (ZT2) and early subjective night (ZT14). Scale bars = 100 μ m.

PER1 expression in the VTA

PER1 was expressed in the VTA of all treatment groups (figure 4.37), however its expression was not significantly rhythmic in each case (figure 4.36, table 4.5). There was however a significant main effect of treatment upon PER1 expression in the VTA ($df=2$, $F=18.181$, $P<0.001$). *Post-hoc* testing revealed a significant increase in PER1 expression in the VTA of the atomoxetine treatment group in comparison to both the methylphenidate treatment group and the saline control ($P<0.01$ and $P<0.001$ respectively). Furthermore, PER1 expression was also greater in the VTA of the methylphenidate treatment group than in that of the saline control ($P<0.05$). No significant main effects of time or interaction of time and treatment upon PER1 expression were detected.

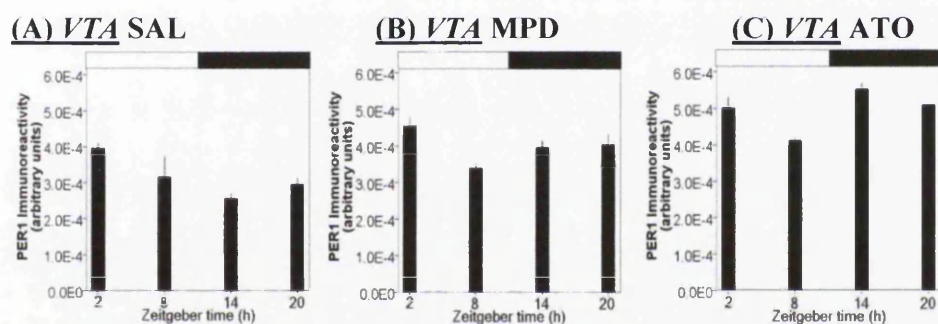

Figure 4.36. PER1 immunoreactivity measured by immunoreactive cell counts in the VTA of mice that underwent chronic treatment of either a saline control (SAL), methylphenidate (MPD) or atomoxetine (ATO). Presence of a fitted curve indicates a significant rhythm as assessed by co-sinor analysis.

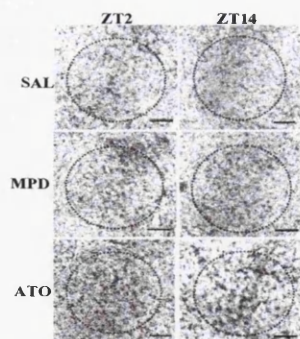

Figure 4.37. Photomicrographs of PER1 immunostaining in the VTA of mice that underwent chronic treatment of either methylphenidate (MPD), atomoxetine (ATO) or a saline control (SAL) during the early subjective day (ZT2) and early subjective night (ZT14). Scale bars = 100 μ m.

PER2 expression in the VTA

PER2 expression was significantly rhythmic, with an acrophase at ZT14 in the VTA of the saline control group (figure 4.38A, table 4.5), whilst its expression was not significantly rhythmic in the VTA of the methylphenidate and atomoxetine treatment groups (figures. 4.38B-C, table 4.5). There was also a significant main effect of time upon PER2 expression in the VTA ($df=3$, $F=4.000$, $P<0.05$), although there was no significant effect of treatment or interaction of time and treatment.

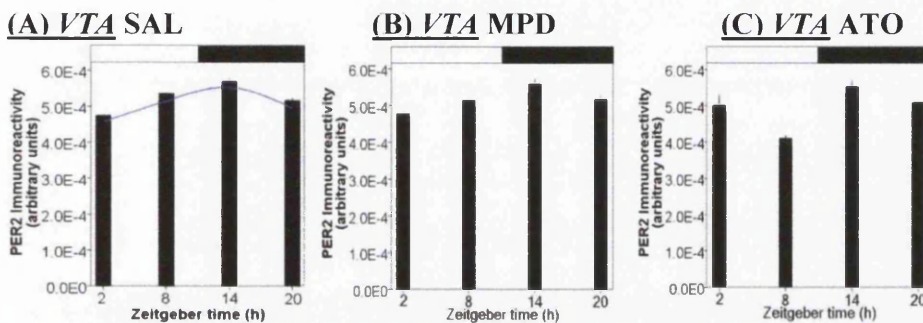

Figure 4.38. PER2 immunoreactivity measured by immunoreactive cell counts in the VTA of mice that underwent chronic treatment of either a saline control (SAL), methylphenidate (MPD) or atomoxetine (ATO). Presence of a fitted curve indicates a significant rhythm as assessed by co-sinor analysis.

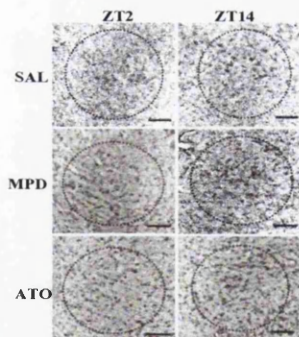

Figure 4.39. Photomicrographs of PER2 immunostaining in the VTA of mice that underwent chronic treatment of either methylphenidate (MPD), atomoxetine (ATO) or a saline control (SAL) during the early subjective day (ZT2) and early subjective night (ZT14). Scale bars = 100 μ m.

c-Fos expression in the VTA

c-Fos was expressed with a significant rhythm in the VTA of the saline control and the methylphenidate treatment groups, with an acrophase at ZT20 in both cases (figures. 4.40A-B, table 4.5), whereas c-Fos expression in the VTA of the atomoxetine treatment group did not exhibit significant rhythmicity (figure 4.40C, table 4.5). A significant main effect of treatment upon c-Fos expression was observed in the VTA ($df=2$, $F=25.803$, $P<0.001$), and *post-hoc* testing revealed a significant increase in c-Fos expression in the VTA of the methylphenidate treatment group compared to both the atomoxetine treatment group and the saline control ($P<0.001$ in both cases). There was also a significant main effect of time upon VTA c-Fos expression ($df=3$, $F=11.271$, $P<0.001$), and a significant interaction of time and treatment ($df=6$, $F=2.848$, $P<0.05$).

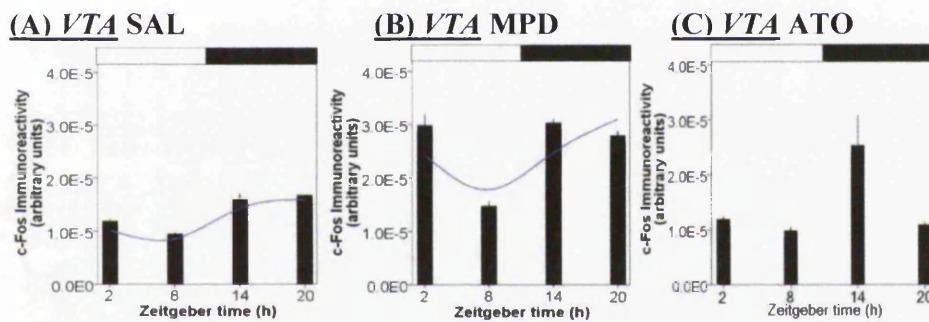

Figure 4.40. c-Fos immunoreactivity measured by immunoreactive cell counts in the VTA of mice that underwent chronic treatment of saline control (SAL), MPD or ATO. Fitted curve = significant rhythm as assessed by co-sinor analysis.

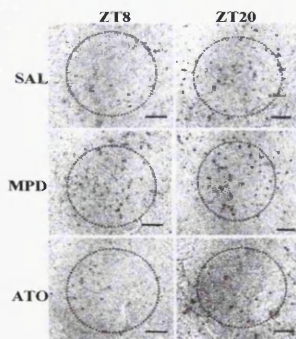

Figure 4.41. Photomicrographs of c-Fos immunostaining in the VTA of mice that underwent chronic treatment of either methylphenidate (MPD), atomoxetine (ATO) or a saline control (SAL) during the mid subjective day (ZT8) and mid subjective night (ZT20). Scale bars = 100 μ m

4.4 Discussion

Chronic administration of both methylphenidate and atomoxetine was shown to exert a number of effects upon the expression of clock proteins and the c-Fos protein, a marker of neuronal activation.

4.4.1 Circadian clock protein expression in the hypothalamus

SCN

Constitutive expression of CLOCK and robust rhythms of PER1 and PER2 expression peaking during the early subjective night were demonstrated in the master pacemaker of the SCN of the saline treated mice, which is in agreement with well documented findings in the literature (Gekakis et al., 1998, Field et al., 2000). c-Fos was rhythmically expressed in the SCN of the saline treated mice, with peak expression in the mid subjective day. Neither methylphenidate nor atomoxetine altered the circadian profiles of PER1, CLOCK or c-Fos. However, c-Fos expression was increased in the SCN by atomoxetine treatment compared to that of the methylphenidate treated mice, thus suggesting that atomoxetine may activate the SCN to a greater extent than methylphenidate.

Methylphenidate reduced PER2 expression in the SCN, and atomoxetine reduced SCN PER2 expression further still. Furthermore, the expression of PER2 was completely phase reversed in the SCN of methylphenidate treated mice, exhibiting an acrophase in the early subjective day to coincide with the time of injection. This is of particular interest since the development of a rat anticipatory locomotor rhythm in response to chronic methylphenidate treatment of an equivalent dose as used in the present study has been reported (Algahim et al., 2009). These findings would also suggest that both methylphenidate and atomoxetine may modulate the master circadian clock via the alteration of PER2 expression, with the greatest effect being exerted by methylphenidate.

The ability of chronic methylphenidate administration to alter the phase of PER2 expression in the SCN is in contrast to the effects of chronic administration of the

psychostimulant methamphetamine, which has been shown to not affect SCN clock gene expression including *PER2* (Masubuchi et al., 2000, Iijima et al., 2002). However it is worth noting that these studies have assessed circadian clock gene expression, and whilst SCN *PER2* protein expression is altered in the present study, this may not necessarily mean that the rhythm of *PER2* mRNA is altered in the same manner, as a functional disconnection between clock genes and their protein products has been documented (Reddy et al., 2006). Hence the unaltered circadian clock gene mRNA observed in the SCN after chronic methamphetamine treatment may not necessarily translate to unaltered profiles of circadian clock gene protein product expression.

Dopamine and its associated neurons have been implicated in SCN functioning, including in the entrainment of the master pacemaker and in the regulation of light input to the retina (Witkovsky, 2004, McClung et al., 2005). The rhythm of noradrenaline in the SCN is driven by the master pacemaker, independently of light input (Cagampang et al., 1994) and it has been proposed as an entrainment signal from the SCN to the peripheral oscillator of the pineal gland, hence exerting regulation of melatonin production (Wongchitrat et al., 2009). It is therefore possible that since methylphenidate is an inhibitor of dopamine and noradrenaline re-uptake by DAT and NET (Madras et al., 2005, Kim et al., 2010), and atomoxetine selectively inhibits NET mediated noradrenaline removal (Kim et al., 2010), the subsequent increases in synaptic dopamine and noradrenaline could impact upon these aspects of the circadian system. Moreover, since the SCN is the site of the master circadian pacemaker, and *PER2* is a core clock protein in the molecular mechanism that drives circadian rhythms (Gekakis et al., 1998, van der Horst et al., 1999, Reppert and Weaver, 2001, Guilding and Piggins, 2007), any alteration in its rhythm could have knock on effects upon not only the other core clock genes and their protein products but also the expression of clock controlled genes and therefore could ultimately affect the physiological and behavioural processes that are regulated by them.

In the present study PER2 was not rhythmically expressed in the DMH of the saline treated mice, and this was in agreement with previous findings (Feillet et al., 2008), and furthermore PER2 expression was unaltered by methylphenidate and atomoxetine. CLOCK, PER1 and c-Fos were rhythmically expressed in the DMH of the saline treated mice, with CLOCK and PER1 expression peaking around the mid subjective day as previously documented (Feillet et al., 2008, Wyse and Coogan, 2010), whilst c-Fos peak expression occurred in the early subjective night. The effects of chronic methylphenidate and chronic atomoxetine treatment upon CLOCK, PER1 and c-Fos expression in the DMH were very similar, with a phase shift in expression of the three proteins, peaking in the early lights-on phase at the time of treatment administration in each case. This would suggest that in the DMH, the mechanism by which these drugs elicit phase shifts share similar properties. However, only methylphenidate induced neuronal activation of the DMH, as demonstrated by an increase in c-Fos expression.

The DMH receives efferents from the SCN, and is thought to be a major output nucleus of the master pacemaker (Saper et al., 2005), with roles in the circadian regulation of various behaviours, including the autonomic stress response, feeding, rhythmic corticosteroid production and the regulation of sleep (Bellinger et al., 1976, Kalsbeek et al., 1996, Bernardis and Bellinger, 1998, DiMicco et al., 2002, Chou et al., 2003). This is of particular interest since methylphenidate and atomoxetine mediated sleep alterations have been documented in ADHD (Sangal et al., 2006, Boonstra et al., 2007, Sobanski et al., 2008). It could therefore be postulated that these effects upon sleep may occur in part through modulation of circadian functioning in the DMH.

Furthermore, numerous studies have documented an association of altered HPA-axis activity with various aspects of ADHD (Virkkunen, 1985, Moss et al., 1995, Hanna et al., 1996, Gaub and Carlson, 1997, Gershon, 2002, Hong et al., 2003, Blomqvist et al., 2007, Sondejker et al., 2007, Lackschewitz et al., 2008, Hastings et al., 2009, van West et al., 2009), and alterations in HPA axis activity by both atomoxetine (Chamberlain et al., 2007a, Sofuoglu et al., 2009) and methylphenidate (Joyce et al.,

1986) have been reported, although a lack of effect of methylphenidate upon plasma cortisol in ADHD has also been shown (Lee et al., 2008). Due to the role the DMH plays in the stress response and the circadian rhythm of corticosteroid production (Bellinger et al., 1976, Kalsbeek et al., 1996, Bernardis and Bellinger, 1998, DiMicco et al., 2002, Chou et al., 2003), it is plausible that the observed effects of ADHD medication upon circadian clock protein expression in the DMH could impact upon these processes also.

In addition to time-keeping signals originating from the SCN, the DMH also receives input from other regions of the hypothalamus, cortex, hippocampus and brainstem (Thompson and Swanson, 1998), and thus may be involved in the incorporation of the two, enabling optimal functioning to suit the behavioural state (Chou et al., 2003). Therefore any alteration in circadian functioning in the DMH could consequently affect the circadian functioning of these brain regions, and *vice versa*.

PVN

PER1 and PER2 were rhythmically expressed in the PVN of the saline treated mice, with peak expression in the early subjective night. An earlier study documented a similar rhythm of PER2 expression although PER1 expression was shown to be arrhythmic (Feillet et al., 2008). In the present study CLOCK expression was rhythmic in the PVN peaking in the mid subjective day of these mice in accordance with previous reports (Wyse and Coogan, 2010). c-Fos was also rhythmically expressed in the saline treated mice with peak expression during the mid subjective day.

Both atomoxetine and methylphenidate affected circadian clock protein expression in the PVN. Atomoxetine treatment caused phase shifts in CLOCK and PER2 with peak expression earlier in the subjective day and in the mid subjective night respectively, whilst the rhythmic expression of PER1 and c-Fos were completely phase reversed to peak in the early subjective day and mid subjective day respectively. In comparison only the rhythmic expression of CLOCK and PER1 were altered in the PVN of the methylphenidate treated mice, with peak CLOCK expression occurring earlier in the subjective day, as seen in the atomoxetine treatment group, and there was a loss of

rhythmic PER1 expression. Methylphenidate and atomoxetine had opposing effects upon the level of PER1 expression, with methylphenidate being shown to increase PER1 expression, whereas atomoxetine treatment reduced the expression of PER1 in the PVN. PER2 expression in the PVN was dampened by both methylphenidate treatment, and to a greater degree atomoxetine treatment. CLOCK expression was also reduced in the PVN by both methylphenidate and atomoxetine treatment. This therefore indicated that atomoxetine not only had a greater influence than methylphenidate upon circadian clock protein expression in the PVN, but atomoxetine also altered the rhythm of neuronal activation in this brain region, as indicated by the phase shift of c-Fos expression.

Direct projections from the DMH to the PVN indicate a functional link between the two hypothalamic regions (ter Horst and Luiten, 1986, Thompson et al., 1996, Elmquist et al., 1998, Chou et al., 2003), and hence it is not surprising that circadian alterations by methylphenidate and atomoxetine are observed in both of these regions. The PVN has also been implicated in the regulation of SCN driven melatonin rhythms (Klein et al., 1983, Vrang et al., 1995, Chou et al., 2003). Similarly to the DMH, the PVN has also been implicated in the regulation of corticosteroid release (Tokunaga et al., 1986, Chou et al., 2003) and the HPA-axis mediated stress response (Thome et al., 2000), and therefore any modulation of circadian clock protein levels and its rhythmicity in the PVN by these drugs, could consequently influence these functions also.

4.4.2 Circadian clock protein expression in the limbic forebrain

In the present study PER2, CLOCK and c-Fos were not rhythmically expressed in the hippocampus and amygdala regions examined of the saline treated mice. PER2 expression has been previously shown to be rhythmic in the mouse BLA, CEA, CA1, CA3 and DG regions (Lamont et al., 2005, Feillet et al., 2008, Wang et al., 2009). Whilst CLOCK expression has been shown to oscillate in the DG, BLA and CEA, and to be arrhythmic in the CA1 and CA3 regions of young adult mice (Wyse and Coogan, 2010).

PER1 was expressed rhythmically in the CA1 and CA3 regions of the saline treated mice with peak expression in the early subjective day, whilst PER1 expression was not rhythmic in the DG, BLA and CEA regions in the saline treated mice. A previous study has also demonstrated arrhythmic PER1 expression in the BLA, and rhythmic PER1 expression in the CA1 with an acrophase in the late subjective night, although unlike the present study PER1 expression was also rhythmic in the CEA and DG regions with acrophases in the mid and late subjective night respectively (Feillet et al., 2008). *PER1* gene expression has also been shown to be rhythmic in the rat hippocampus and amygdala (Li et al., 2009a).

However when drawing comparisons between the current data and other studies a number of factors, which could impact upon the patterns of clock gene and protein expression should be noted. Firstly, in the present study circadian rhythms of clock protein expression were assessed by immunohistochemical analysis at four six-hourly time-points across the cycle, and therefore there may not be the temporal resolution to detect significant rhythmicity as documented in other studies that have examined circadian rhythms at more frequent time-points. Secondly, as previously mentioned a functional disconnection between clock genes and their protein products has been documented (Reddy et al., 2006), and hence rhythmic gene expression may not necessarily translate to a similar protein expression profile. Thirdly, not only may there be differences in the pharmacokinetics of rats and mice (Koda et al., 2010), but also mouse strain differences in the circadian system, including the endogenous period and phase shifting light responses have been reported (Schwartz and Zimmerman, 1990, Hofstetter et al., 1995, Feillet et al., 2008), and lastly age has also been shown to impact upon circadian clock gene and protein expression (eg Ando et al. 2010, Wyse and Coogan, 2010).

Methylphenidate treatment resulted in the loss of rhythmic PER1 expression in the CA1 and CA3 regions, an effect also observed upon *PER1* gene expression in the hippocampus of rats undergoing withdrawal after chronic morphine treatment (Li et al., 2009a). PER1 expression in the CA1 and CA3 regions was unaltered by atomoxetine treatment. However, atomoxetine did induce rhythmic expression of clock proteins that were otherwise arrhythmic in the saline control mice. These included PER2 expression in the CA1 and CEA regions with acrophases in the early

subjective day and mid subjective night respectively, and a rhythm of CLOCK expression in the BLA peaking in the early subjective day. The increase in c-Fos expression indicated that methylphenidate caused an increase in neuronal activation throughout the limbic forebrain, whereas atomoxetine only exerted an effect upon neuronal activation in the DG, and this was to a lesser degree than that of methylphenidate. Furthermore, methylphenidate treatment induced a rhythm of c-Fos expression in the CA1 region, and atomoxetine treatment induced a rhythm of c-Fos expression in the DG, indicating that neuronal activation in response to these drugs is subject to regulation by a circadian oscillator in these regions.

The main functions of the amygdala are thought to be involved with the reward system, and in forming associations between negative emotional stimuli and environmental cues (LeDoux, 2000, Davis and Whalen, 2001, Koob and Le Moal, 2001, Everitt et al., 2003, Nestler and Carlezon, 2006). Whereas the hippocampus is implicated in the functions of declarative memory and spatial learning (Nestler and Carlezon, 2006), and it has been postulated that these processes may be altered by disruptions in sleep and circadian rhythms (Dijk et al., 1992, Peigneux et al., 2004, Ellenbogen et al., 2006, Wright et al., 2006, Ruby et al., 2008, Wang et al., 2009). This is demonstrated by *PER2* knockout mice that exhibit attenuated hippocampal long-term potentiation (Wang et al., 2009) and *PER1* knockout mice which demonstrate impaired performance on memory tasks (Jilg et al., 2010). Hence the alterations of circadian protein expression in the limbic forebrain elicited by methylphenidate and atomoxetine could impact upon these processes also.

4.4.3 Circadian clock protein expression in the cerebral cortex

PER1, PER2, CLOCK and c-Fos were all arrhythmically expressed in the CC, PLC, and ILC of the saline control mice. Atomoxetine was shown to have a greater effect upon the circadian clock proteins than methylphenidate, and this was in the CC where rhythmic expression of CLOCK with an acrophase in the early subjective day and an increase in PER2 expression were observed. Atomoxetine also caused the expression of c-Fos to be rhythmic in the ILC, with peak expression during the mid subjective night, indicating that atomoxetine induced circadian regulation of neuronal activation in the ILC. Methylphenidate treatment however produced an

increase in c-Fos expression in all three regions of the cerebral cortex examined, thus demonstrating that whilst methylphenidate does not effect circadian functioning of the cerebral cortex it does cause a widespread increase in neuronal activation throughout the region.

A contributory factor to the greater effects of atomoxetine upon cerebral cortex circadian clock protein expression observed could be an increased abundance of NET compared to DAT, since this has been observed in the prefrontal cortex (Gehlert et al., 1993, Soucy et al., 1997, Sesack et al., 1998, Koda et al., 2010). Furthermore, atomoxetine has been shown to increase dopamine levels in the prefrontal cortex, due to the non-selective uptake of dopamine by NET, which is blocked by atomoxetine (Bymaster et al., 2002, Koda et al., 2010).

The frontal cortex is known to be involved in working memory, attention, impulse control and other executive functions (Nestler and Carlezon, 2006), and as previously mentioned input to the DMH is received from the frontal cortex along with other brain regions to allow for the incorporation of behavioural and time-keeping cues (Thompson and Swanson, 1998), and could therefore promote circadian regulation of these behaviours associated with the frontal cortex, and for perturbations in circadian clock protein expression in the cerebral cortex to impact upon these behaviours.

4.4.4 Circadian clock protein expression in the striatum

The expression of PER1, PER2, CLOCK and c-Fos was not rhythmic in the AcbC and AcbSh of the saline control. There have been mixed reports regarding the oscillation of clock gene expression in the striatum. In accordance with the current findings, arrhythmic *CLOCK* gene expression has been demonstrated in the nucleus accumbens of the rat (Li et al., 2009a), whereas *PER* gene expression in the nucleus accumbens of rats has been shown to be both rhythmic (Li et al., 2009a) and arrhythmic (Masubuchi et al., 2000). PER1, PER2 and CLOCK expression was rhythmic however in the CPu of the saline control mice in the present study, with PER1 and PER2 exhibiting acrophases in the early subjective day, and a CLOCK acrophase just after the mid subjective night. Again these protein profiles differ from the corresponding gene expression profiles reported in an earlier study, where *PER1*

and *PER2* expression was shown to be rhythmic, whilst *CLOCK* expression was arrhythmic in the CPu of rats (Masubuchi et al., 2000).

Chronic methylphenidate treatment exerted a more widespread effect upon striatal protein expression than chronic atomoxetine treatment. The effects of atomoxetine upon protein expression were mainly limited to the CPu, including an increase in *PER2* and *PER1* expression, and a phase shift of *CLOCK* expression to peak in the mid subjective day. Although an increase in *PER2* expression in the *AcbC* by atomoxetine treatment was also observed, and this is in contrast with the effects of the antidepressant fluoxetine, of which chronic administration decreased striatal *PER2* gene expression in the mouse striatum (Uz et al., 2005). However, whilst both atomoxetine and fluoxetine belong to the same class of tri-cyclic antidepressants, they do differ in their actions upon the catecholaminergic systems, with atomoxetine being primarily an inhibitor of noradrenaline reuptake (Kim et al., 2010), whereas fluoxetine is a 5-HT selective reuptake inhibitor (Thome et al., 2000).

On the other hand, methylphenidate treatment exerted effects upon protein expression in all three regions of the striatum examined, and showed similarities to the effects of other psychostimulants upon the circadian system in the striatum. Methylphenidate phase reversed the rhythm of *PER2* expression in the CPu, with peak expression in the early subjective night, which is very similar to the effect upon *PER2* expression in the CPu of chronic methamphetamine treatment, which has been shown to phase reverse *PER2* gene expression in this brain region (Masubuchi et al., 2000). Similarly to the documented increase in striatal *PER1* expression by chronic cocaine treatment (Uz et al., 2005), *PER1* expression was increased by methylphenidate in all three striatal regions examined, but to a lesser degree in the CPu than exhibited by the atomoxetine treated mice. *PER2* expression was also increased in the CPu by methylphenidate and this was to a greater degree than that of the atomoxetine treated mice, but in contrast to the effect of chronic cocaine treatment, which has been shown to decrease *PER2* expression (Uz et al., 2005).

Similar to the effect of atomoxetine, methylphenidate also phase shifted *CLOCK* expression in the CPu, but this was to an acrophase in the early subjective day, which

was the time of methylphenidate administration. Unlike atomoxetine, methylphenidate induced a rhythm of PER2 expression in the AcbSh, and also modulated c-Fos expression, and this was in all three region of the striatum, where its expression was increased in the CPu and AcbSh in comparison to both the saline and atomoxetine treated mice, and increased in the AcbC in comparison to the atomoxetine treated mice. This therefore indicated that methylphenidate increased neuronal activation throughout the striatum, and this is in agreement with findings that methylphenidate increased *c-Fos* gene expression in the striatum (Yano and Steiner, 2005a, Yano and Steiner, 2005b, Steiner et al., 2010).

Furthermore the findings of the present study that in comparison to the anti-depressant atomoxetine, the psychostimulant methylphenidate exerted greater effect upon striatal clock gene expression, is in accordance with an earlier report that the psychostimulant cocaine exerted greater influence upon clock gene expression in the striatum than did the antidepressant fluoxetine (Uz et al., 2005). It is known that atomoxetine does not increase extracellular noradrenaline levels in the striatum (Koda et al., 2010), due to a lack of NET as demonstrated by minimal immunoreactivity fibres (Schroeter et al., 2000), and this could therefore underlie the minimal effect of atomoxetine upon striatal circadian clock protein expression in comparison to methylphenidate.

Whilst the effects of methylphenidate upon the circadian system of the striatum shared some similarities with the effects of methamphetamine and cocaine, the effect upon all the proteins was not identical. The psychostimulants methylphenidate, methamphetamine and cocaine all share the pharmacological property to block reuptake of dopamine and noradrenaline, thus enhancing their actions at postsynaptic receptors (Yano and Steiner, 2007, Steiner et al., 2010), and the systemic administration of methylphenidate has been shown to have a potency that is equivalent to that of cocaine and amphetamine (Parran and Jasinski, 1991, Massello and Carpenter, 1999, Algham et al., 2009). However, cocaine and methamphetamine differ from methylphenidate as they both have the capacity to affect serotonin levels also (Russell, 2003, Yano and Steiner, 2007, Steiner et al., 2010), and it is therefore possible that it is these contrasting pharmacological properties that may be responsible for the differential molecular effects of these drugs.

Along with the VTA, the nucleus accumbens is heavily implicated in the brain's reward system, with dopaminergic input to the nucleus accumbens from the VTA being central to drug reward (Wise, 1998, Koob and Le Moal, 2001, Nestler and Carlezon, 2006, Imbesi et al., 2009). Furthermore, the nucleus accumbens and CPU are thought to be involved in the rhythm of locomotor activity and hyperactive behaviour (Masubuchi et al., 2000). It is therefore of particular interest that methylphenidate exerts an effect upon circadian clock protein expression in the nucleus accumbens, since hyperactivity is a core symptom of ADHD (Rosler et al., 2004) and deficits in the circadian system have been shown to produce hyperactive behaviour as demonstrated by the CLOCK mutant mouse (McClung et al., 2005).

4.4.5 Circadian clock protein expression in the ventral tegmental area

PER2 and c-Fos were rhythmically expressed in the VTA of the saline control mice with acrophases during the early and mid subjective night, whilst PER1 and CLOCK were not. Previous research has documented rhythmic expression of the *PER2*, *PER1* and *CLOCK* genes in the rat VTA (Li et al., 2009a).

Both treatments influenced protein expression in the VTA. The rhythmicity of PER2 and c-Fos expression in the VTA were lost by both methylphenidate and atomoxetine treatment, although methylphenidate did cause an increase in c-Fos and PER1 expression. Atomoxetine treatment caused a greater still increase in PER1 expression than that of methylphenidate, and also increased the expression of CLOCK. This therefore indicated that not only did both treatments perturb circadian clock protein expression but also abolished the circadian rhythm of neuronal activation, whilst methylphenidate also increased the degree of neuronal activation in the VTA.

The VTA is involved in the regulation of attention, memory, reward and motivation (Chudasama and Robbins, 2004, Wise, 2004, Nicola et al., 2005). Furthermore the VTA neurons are the main source of dopamine projections to the limbic forebrain (Chudasama and Robbins, 2004, Wise, 2004, Nicola et al., 2005) and the VTA has been shown to part of a synaptically linked circuit with the medial preoptic nucleus and the SCN (Luo and Aston-Jones, 2009). Moreover, CLOCK has been implicated in the regulation of dopaminergic neurotransmission in the VTA, as part of the

reward circuit (McClung et al., 2005). It is therefore possible that an alteration in VTA functioning could have downstream effects upon the circadian regulation of the behavioural processes regulated by these brain regions also, including the sleep-wake cycle (Luo and Aston-Jones, 2009).

4.4.6 Mechanisms by which the ADHD medications interact with the circadian system

A possible mechanism by which methylphenidate and atomoxetine could produce the alterations to the circadian system of the mouse brain observed could be via modulation of aspects of the cAMP system (Uz et al., 2005). The phosphorylation of mitogen activated protein kinase (MAPK) and cAMP response element binding protein (CREB) is stimulated by dopamine (Yan et al., 1999) and noradrenaline (Tamotsu et al., 1995, Thonberg et al., 2002). An induction of *PER1* expression by activation of MAPK and CREB has been demonstrated *in vitro* (Akashi and Nishida, 2000, Yagita and Okamura, 2000), and in addition to *PER1*, a number of other circadian clock genes contain are known to possess CRE binding sequences including *CLOCK*, *BMAL1*, and *PER2* (Takahata et al., 2000, Travnickova-Bendova et al., 2002).

The presence of a methamphetamine sensitive oscillator that functions independently of the SCN has been widely documented (Mohawk et al., 2009). Under conditions of chronic methamphetamine treatment the rodent locomotor rhythm has been shown to become uncoupled from the LD cycle, and perturbed physiological rhythms in association with this has been observed (Honma et al., 1986, Honma et al., 1988, Tataroglu et al., 2006). There are a number of indications that the formation of the methamphetamine-induced oscillation may involve the dopaminergic system, including the ability of methamphetamine to influence dopaminergic neuronal functioning (Masubuchi et al., 2000), and the effect of the dopamine receptor antagonist, haloperidol, to cause phase-dependant phase shifts in the methamphetamine induced locomotor rhythm (Honma and Honma, 1995). On the basis that the dopaminergic system is involved in the methamphetamine sensitive oscillator, then activation of this clock may not be limited to just methamphetamine, but could be extended to other pharmacological agents that interact with the

catecholaminergic systems, including methylphenidate. This hypothesis is further supported by the rat anticipatory locomotor rhythm produced in response to chronic methylphenidate treatment (Algahim et al., 2009), and the perturbation of circadian clock protein profiles throughout the mouse brain by chronic methylphenidate administration observed in the present study. Furthermore atomoxetine has been shown to interact with the dopaminergic system in brain regions such as the prefrontal cortex, where it increases levels of noradrenaline and dopamine (Bymaster et al., 2002, Koda et al., 2010), and so could interact with this SCN-independent oscillator also. However in order to determine this not only will the corresponding effects upon locomotor activity need to be studied, but circadian profiles of clock protein expression and the behavioural rhythm will need to be examined under free-running conditions to determine if they persist in the absence of light as the dominant Zeitgeber.

4.4.7 Conclusions

The current data demonstrates numerous effects of both methylphenidate and atomoxetine upon the circadian system in a neuroanatomically differentiated manner. This could therefore have implications for the functioning of various behaviours that are governed by these brain regions, and explain the wide variety of therapeutic and adverse side effects of these drugs, including upon the sleep/wake cycle that are observed.

Chapter 5: Conclusions

5.1 Overall discussion

The main aims of this work were firstly to establish a non-invasive method of sampling the human circadian clock, secondly to apply this technique for the assaying of human circadian clock functioning in adult ADHD, and thirdly to investigate the effects of ADHD medication upon the circadian system.

The oral mucosa of healthy participants was the tissue chosen, since sampling could be carried out by the study participants themselves, without the need to attend a sleep clinic, therefore minimising the risk of circadian disturbance caused by the sampling protocol. The successful quantification of robustly rhythmic circadian clock gene expression and the interactions of the molecular circadian rhythms with behaviour, indicating the molecular circadian rhythm parameters as markers of circadian clock functioning, demonstrated the usefulness of the technique. However although adequate for RT-PCR gene expression analysis in the present study, the RNA integrity was relatively low, and therefore for future studies it may be useful to utilise a circadian oscillator present in other peripheral tissues such as hair cells, as this has been documented to be a tissue that is easily accessible and from which highly intact RNA can be extracted (Akashi et al., 2010). Furthermore with larger quantities of RNA, a greater number of clock genes could be assayed and microarray techniques could be implemented for a more standardised screening of a larger cohort of subjects for multiple clock genes and their associated clock controlled genes.

Once this method had been validated, the next step was to apply this technique to a larger clinical cohort of ADHD patients and healthy controls, and this revealed significant perturbations in the molecular circadian clock in ADHD, in addition to the disturbance of endocrine and behavioural rhythms in these patients, therefore further validating the protocol as an accurate method of assaying human circadian clock function in both healthy subjects and patient populations.

The findings of the present study provide much scope for further investigations into the circadian deficit in ADHD. Analysis of a wider number of core circadian clock genes would provide vital information on what effect the disturbed rhythmicity of clock gene expression observed has upon the other molecular clock components, or

indeed whether the perturbations observed could be the result of a wider deficit in the core molecular clock mechanism. Furthermore, analysis of the expression of core clock controlled genes could help elucidate the potential effects of perturbed peripheral clock gene expression upon downstream behavioural and physiological processes. Moreover, comorbidity of ADHD with other disorders has been documented, for example with personality disorders (Modestin et al., 2001, Biederman and Faraone, 2005), and ADHD itself is differentiated as 3 separate subtypes; predominantly hyperactive-impulsive, predominantly inattentive and combined (McGough and Barkley, 2004, Biederman and Faraone, 2005). Therefore, further research to ascertain if deficits in the circadian system are associated with specific ADHD subtypes and symptomology would be valuable. Since, chronic sleep onset insomnia has been associated with ADHD (Boonstra et al., 2007, Van Veen et al., 2010), it would also be of interest to investigate if the circadian rhythm disturbance associated with ADHD in the present study, is replicated in ADHD cohorts that are comorbid with insomnia and those that do not suffer from a sleep disorder, to establish if the circadian deficit is associated with ADHD or rather with an underlying sleep disorder that is comorbid with ADHD.

The significant disturbance of the circadian system observed in ADHD, raised the question of what impact ADHD medication may have upon the circadian clock, and if perhaps some of the therapeutic and adverse side-effects of these medications may exert their action in part through modulation of the circadian clock. To examine this hypothesis further we assessed the effects of chronic administration of the psychostimulant methylphenidate and the anti-depressant atomoxetine upon circadian clock gene protein product expression throughout various regions of the rodent brain, that are implicated in the circadian clock and in the catecholaminergic systems that are targets of these drugs. Both drugs were shown to influence circadian clock protein expression in numerous brain regions in alternate manners. Both the mRNA and the proteins of the core clock components play a role in various aspects of the molecular clockwork, and so the sampling of clock protein levels in the current study provide vital information regarding the functioning of the molecular circadian system, although further analysis of mRNA levels by *in situ* hybridization would be required to validate whether the disturbance seen at the protein level is also

replicated in mRNA expression. Furthermore, the sampling of a greater number of time-points would further describe the molecular rhythms.

Due to the indications of a potential dysfunction in the entrainment of the circadian clock in ADHD in the present study and the ability of methylphenidate and atomoxetine to alter molecular circadian rhythms in the rodent brain, including in the master pacemaker, it may be postulated that chronic administration of these medications could act as a compensatory mechanism for the deficits in the entrainment of the circadian system to environmental time-keeping cues in ADHD. Future work to assess how the impact of methylphenidate and atomoxetine upon the molecular clockwork correlates with the rodent behavioural rhythm under conditions without light as the dominant Zeitgeber, would help elucidate the effects of these medications upon intrinsic rhythmicity of the circadian clock and to further understand what implications the modulation of the molecular circadian system has upon behaviour. Moreover assessment of how these medications affect molecular and behavioural rhythms in rodent models of ADHD would provide valuable insight into how these medications interact with the master circadian pacemaker and the slave oscillators of peripheral brain regions in ADHD. This study could also be extended further to assess the affects of ADHD medication upon the human circadian system also, by utilising peripheral clock gene expression as a marker of the molecular circadian clock, and by assessing endocrine and behavioural rhythms in pre and post medicated ADHD patients. Furthermore it would be of interest to examine the circadian rhythms of expression of a wider set of clock genes and clock controlled genes in this manner, as this would contribute to further understanding of both the positive and negative effects of pharmacological treatments for ADHD upon the circadian system.

5.1.1 Conclusions

To summarise, the establishment of deficits in the circadian system on the behavioural, molecular and endocrine levels in ADHD, and furthermore the associations observed between circadian rhythm parameters and clinical ADHD scores indicate a key role for circadian clock disturbance in the manifestation of sleep disturbance and clinical symptoms. Moreover, the interactions of the

pharmacological ADHD treatments with the molecular circadian clock indicate a potential mechanism by which these treatments may interact with the circadian system. Therefore, further elucidation of the effects of ADHD treatments upon the circadian system of ADHD patients could ultimately prove beneficial in understanding the symptomology of the disorder and the most appropriate and efficacious treatments for the disorder.

Appendix 1: A comparison of the statistical analysis of the immunoreactivity data assessed by immunoreactive cell counts and optical density.

Brain Region	Treatment	Method of measuring immunoreactivity	Acrophase of immunoreactivity (Zeitgeber time)			
			CLOCK	PER1	PER2	c-Fos
SCN	SAL	Cell Counts	n.s.	~ZT14	~ZT14	~ZT6
		Optical density	n.s.	~ZT14	~ZT14	~ZT10
	MPD	Cell Counts	n.s.	~ZT14	~ZT2	~ZT6
		Optical density	n.s.	~ZT14	~ZT2	~ZT6
	ATO	Cell Counts	n.s.	~ZT14	n.s.	~ZT6
		Optical density	n.s.	~ZT14	n.s.	~ZT10
PVN	SAL	Cell Counts	~ZT8	~ZT14	~ZT14	~ZT20
		Optical density	~ZT6	~ZT16	~ZT11	~ZT20
	MPD	Cell Counts	~ZT5	n.s.	~ZT14	~ZT20
		Optical density	~ZT24	n.s.	~ZT15	~ZT20
	ATO	Cell Counts	~ZT5	~ZT2	~ZT20	~ZT8
		Optical density	~ZT4	~ZT2	~ZT21	~ZT8
CPu	SAL	Cell Counts	~ZT20	~ZT2	~ZT2	n.s.
		Optical density	~ZT22	~ZT1	~ZT4	n.s.
	MPD	Cell Counts	~ZT2	~ZT2	~ZT14	n.s.
		Optical density	~ZT2	~ZT2	~ZT15	n.s.
	ATO	Cell Counts	~ZT5	~ZT2	~ZT2	n.s.
		Optical density	~ZT2	~ZT1	~ZT2	n.s.
CC	SAL	Cell Counts	n.s.	n.s.	n.s.	n.s.
		Optical density	n.s.	n.s.	n.s.	n.s.
	MPD	Cell Counts	n.s.	n.s.	n.s.	n.s.
		Optical density	n.s.	n.s.	n.s.	n.s.
	ATO	Cell Counts	~ZT2	n.s.	n.s.	n.s.
		Optical density	n.s.	n.s.	n.s.	n.s.
VTA	SAL	Cell Counts	n.s.	n.s.	~ZT14	~ZT20
		Optical density	n.s.	n.s.	~ZT15	~ZT19
	MPD	Cell Counts	n.s.	n.s.	n.s.	~ZT20
		Optical density	n.s.	n.s.	n.s.	~ZT20
	ATO	Cell Counts	n.s.	n.s.	n.s.	n.s.
		Optical density	n.s.	n.s.	n.s.	n.s.

A1.1 Summary table comparing the co-sinor analysis of CLOCK, PER1, PER2 and c-Fos immunoreactivity assessed by measurement of immunoreactive cell counts and optical density. n.s. = not significantly rhythmic.

Protein	Brain Region	Method of measuring immunoreactivity	Main effect of time	Main effect of treatment	Interaction of time x treatment
CLOCK	SCN	Cell Counts	n.s.	n.s.	n.s.
		Optical density	n.s.	n.s.	n.s.
	PVN	Cell Counts	P<0.05	n.s.	n.s.
		Optical density	P<0.01	P<0.001	n.s.
	CPu	Cell Counts	P<0.01	n.s.	P<0.05
		Optical density	P<0.001	n.s.	n.s.
	CC	Cell Counts	n.s.	n.s.	n.s.
		Optical density	n.s.	n.s.	n.s.
	VTA	Cell Counts	n.s.	n.s.	n.s.
		Optical density	P<0.001	P<0.001	P<0.01
PER1	SCN	Cell Counts	P<0.001	n.s.	n.s.
		Optical density	P<0.01	n.s.	n.s.
	PVN	Cell Counts	n.s.	P<0.001	n.s.
		Optical density	P<0.01	P<0.001	P<0.001
	CPu	Cell Counts	n.s.	P<0.01	P<0.05
		Optical density	P<0.001	P<0.001	n.s.
	CC	Cell Counts	P<0.05	n.s.	n.s.
		Optical density	n.s.	n.s.	n.s.
	VTA	Cell Counts	n.s.	P<0.001	n.s.
		Optical density	n.s.	P<0.001	n.s.
PER2	SCN	Cell Counts	n.s.	P<0.001	P<0.001
		Optical density	n.s.	P<0.001	n.s.
	PVN	Cell Counts	n.s.	P<0.001	n.s.
		Optical density	P<0.01	P<0.001	P<0.05
	CPu	Cell Counts	P<0.05	P<0.001	P<0.001
		Optical density	n.s.	P<0.001	P<0.001
	CC	Cell Counts	P<0.05	n.s.	n.s.
		Optical density	n.s.	P<0.01	n.s.
	VTA	Cell Counts	n.s.	P<0.05	n.s.
		Optical density	n.s.	P<0.05	n.s.
c-Fos	SCN	Cell Counts	P<0.001	n.s.	n.s.
		Optical density	P<0.001	P<0.05	n.s.
	PVN	Cell Counts	n.s.	n.s.	P<0.01
		Optical density	n.s.	n.s.	P<0.001
	CPu	Cell Counts	P<0.001	P<0.001	P<0.05
		Optical density	n.s.	P<0.001	P<0.05
	CC	Cell Counts	P<0.001	P<0.001	n.s.
		Optical density	P<0.05	n.s.	n.s.
VTA	Cell Counts	P<0.001	n.s.	P<0.05	
	Optical density	P<0.001	n.s.	P<0.05	

A1.2 Summary table comparing the ANOVA statistics of the CLOCK, PER1, PER2 and c-Fos immunoreactivity data assessed by measurement of immunoreactive cell

counts and optical density. n.s. = not significantly rhythmic. A 2-way ANOVA testing for main effects of time and treatment, with *Tukey post-hoc* analysis was carried out.

Bibliography

- ABARCA, C., ALBRECHT, U. & SPANAGEL, R. 2002. Cocaine sensitization and reward are under the influence of circadian genes and rhythm. *Proc Natl Acad Sci U S A*, 99, 9026-30.
- ABE, M., HERZOG, E. D. & BLOCK, G. D. 2000. Lithium lengthens the circadian period of individual suprachiasmatic nucleus neurons. *Neuroreport*, 11, 3261-4.
- ABRAHAMSON, E. E. & MOORE, R. Y. 2001. Suprachiasmatic nucleus in the mouse: retinal innervation, intrinsic organization and efferent projections. *Brain Res*, 916, 172-91.
- ADAM, E. K., HAWKLEY, L. C., KUDIENKA, B. M. & CACIOPPO, J. T. 2006. Day-to-day dynamics of experience--cortisol associations in a population-based sample of older adults. *Proc Natl Acad Sci U S A*, 103, 17058-63.
- ADLER, L. A., LIEBOWITZ, M., KRONENBERGER, W., QIAO, M., RUBIN, R., HOLLANDBECK, M., DELDAR, A., SCHUH, K. & DURELL, T. 2009a. Atomoxetine treatment in adults with attention-deficit/hyperactivity disorder and comorbid social anxiety disorder. *Depress Anxiety*, 26, 212-21.
- ADLER, L. A., SPENCER, T., BROWN, T. E., HOLDNACK, J., SAYLOR, K., SCHUH, K., TRZEPACZ, P. T., WILLIAMS, D. W. & KELSEY, D. 2009b. Once-daily atomoxetine for adult attention-deficit/hyperactivity disorder: a 6-month, double-blind trial. *J Clin Psychopharmacol*, 29, 44-50.
- AKASHI, M. & NISHIDA, E. 2000. Involvement of the MAP kinase cascade in resetting of the mammalian circadian clock. *Genes & development*, 14, 645-9.
- AKASHI, M., SOMA, H., YAMAMOTO, T., TSUGITOMI, A., YAMASHITA, S., NISHIDA, E., YASUDA, A., LIAO, J. K. & NODE, K. 2010. Noninvasive method for assessing the human circadian clock using hair follicle cells. *Proc Natl Acad Sci U S A*, 107, 15643-8.
- AKYOL, O., ZOROGLU, S. S., ARMUTCU, F., SAHIN, S. & GUREL, A. 2004. Nitric oxide as a physiopathological factor in neuropsychiatric disorders. *In Vivo*, 18, 377-90.
- ALEXANDER, G. E., DELONG, M. R. & STRICK, P. L. 1986. Parallel organization of functionally segregated circuits linking basal ganglia and cortex. *Annu Rev Neurosci*, 9, 357-81.

- ALGAHIM, M. F., YANG, P. B., BURAU, K. D., SWANN, A. C. & DAFNY, N. 2010. Repetitive ritalin treatment modulates the diurnal activity pattern of young SD male rats. *Cent Nerv Syst Agents Med Chem*, 10, 247-57.
- ALGAHIM, M. F., YANG, P. B., WILCOX, V. T., BURAU, K. D., SWANN, A. C. & DAFNY, N. 2009. Prolonged methylphenidate treatment alters the behavioral diurnal activity pattern of adult male Sprague-Dawley rats. *Pharmacol Biochem Behav*, 92, 93-9.
- ALI, N. J., PITSON, D. J. & STRADLING, J. R. 1993. Snoring, sleep disturbance, and behaviour in 4-5 year olds. *Arch Dis Child*, 68, 360-6.
- AMONS, P. J., KOOIJ, J. J., HAFFMANS, P. M., HOFFMAN, T. O. & HOENCAMP, E. 2006. Seasonality of mood disorders in adults with lifetime attention-deficit/hyperactivity disorder (ADHD). *J Affect Disord*, 91, 251-5.
- ANDERSEN, P. H., GINGRICH, J. A., BATES, M. D., DEARRY, A., FALARDEAU, P., SENOGLES, S. E. & CARON, M. G. 1990. Dopamine receptor subtypes: beyond the D1/D2 classification. *Trends Pharmacol Sci*, 11, 231-6.
- ANDO, H., USHIJIMA, K., KUMAZAKI, M., TAKAMURA, T., YOKOTA, N., SAITO, T., IRIE, S., KANEKO, S. & FUJIMURA, A. 2010. Influence of age on clock gene expression in peripheral blood cells of healthy women. *J Gerontol A Biol Sci Med Sci*, 65, 9-13.
- ANGELOV, N., MOUTSOPOULOS, N., JEONG, M. J., NARES, S., ASHCROFT, G. & WAHL, S. M. 2004. Aberrant mucosal wound repair in the absence of secretory leukocyte protease inhibitor. *Thromb Haemost*, 92, 288-97.
- ANTLE, M. C., GLASS, J. D. & MISTLBERGER, R. E. 2000. 5-HT(1A) autoreceptor antagonist-induced 5-HT release in the hamster suprachiasmatic nuclei: effects on circadian clock resetting. *Neurosci Lett*, 282, 97-100.
- ANTLE, M. C., KRIEGSFELD, L. J. & SILVER, R. 2005. Signaling within the master clock of the brain: localized activation of mitogen-activated protein kinase by gastrin-releasing peptide. *J Neurosci*, 25, 2447-54.
- ANTLE, M. C. & MISTLBERGER, R. E. 2000. Circadian clock resetting by sleep deprivation without exercise in the Syrian hamster. *J Neurosci*, 20, 9326-32.
- ARCHER, S. N., CARPEN, J. D., GIBSON, M., LIM, G. H., JOHNSTON, J. D., SKENE, D. J. & VON SCHANTZ, M. 2010. Polymorphism in the PER3

- promoter associates with diurnal preference and delayed sleep phase disorder. *Sleep*, 33, 695-701.
- ARCHER, S. N., VIOLA, A. U., KYRIAKOPOULOU, V., VON SCHANTZ, M. & DIJK, D. J. 2008. Inter-individual differences in habitual sleep timing and entrained phase of endogenous circadian rhythms of BMAL1, PER2 and PER3 mRNA in human leukocytes. *Sleep*, 31, 608-17.
- ARENDRT, J. & SKENE, D. J. 2005. Melatonin as a chronobiotic. *Sleep Med Rev*, 9, 25-39.
- ARMSTRONG, S. M., MCNULTY, O. M., GUARDIOLA-LEMAITRE, B. & REDMAN, J. R. 1993. Successful use of S20098 and melatonin in an animal model of delayed sleep-phase syndrome (DSPS). *Pharmacol Biochem Behav*, 46, 45-9.
- ASHER, G. & SCHIBLER, U. 2006. A CLOCK-less clock. *Trends Cell Biol*, 16, 547-9.
- ASTON-JONES, G., CHEN, S., ZHU, Y. & OSHINSKY, M. L. 2001. A neural circuit for circadian regulation of arousal. *Nat Neurosci*, 4, 732-8.
- ASTON, C., JIANG, L. & SOKOLOV, B. P. 2004. Microarray analysis of postmortem temporal cortex from patients with schizophrenia. *J Neurosci Res*, 77, 858-66.
- ATKINSON, M., KRIPKE, D. F. & WOLF, S. R. 1975. Autorhythmometry in manic-depressives. *Chronobiologia*, 2, 325-35.
- ATON, S. J., COLWELL, C. S., HARMAR, A. J., WASCHEK, J. & HERZOG, E. D. 2005. Vasoactive intestinal polypeptide mediates circadian rhythmicity and synchrony in mammalian clock neurons. *Nat Neurosci*, 8, 476-83.
- AUTTI-RAMO, I. 2000. Twelve-year follow-up of children exposed to alcohol in utero. *Dev Med Child Neurol*, 42, 406-11.
- BABINSKI, L. M., HARTSOUGH, C. S. & LAMBERT, N. M. 1999. Childhood conduct problems, hyperactivity-impulsivity, and inattention as predictors of adult criminal activity. *J Child Psychol Psychiatry*, 40, 347-55.
- BABKOFF, H., CASPY, T., MIKULINCER, M. & SING, H. C. 1991. Monotonic and rhythmic influences: a challenge for sleep deprivation research. *Psychol Bull*, 109, 411-28.

- BAE, K., JIN, X., MAYWOOD, E. S., HASTINGS, M. H., REPPERT, S. M. & WEAVER, D. R. 2001. Differential functions of mPer1, mPer2, and mPer3 in the SCN circadian clock. *Neuron*, 30, 525-36.
- BAILER, U., WIESEGGER, G., LEISCH, F., FUCHS, K., LEITNER, I., LETMAIER, M., KONSTANTINIDIS, A., STASTNY, J., SIEGHART, W., HORNİK, K., MITTERAUER, B., KASPER, S. & ASCHAUER, H. N. 2005. No association of clock gene T3111C polymorphism and affective disorders. *Eur Neuropsychopharmacol*, 15, 51-5.
- BALDO, B. A., GUAL-BONILLA, L., SIJAPATI, K., DANIEL, R. A., LANDRY, C. F. & KELLEY, A. E. 2004. Activation of a subpopulation of orexin/hypocretin-containing hypothalamic neurons by GABAA receptor-mediated inhibition of the nucleus accumbens shell, but not by exposure to a novel environment. *Eur J Neurosci*, 19, 376-86.
- BALSALOBRE, A. 2002. Clock genes in mammalian peripheral tissues. *Cell Tissue Res*, 309, 193-9.
- BALSALOBRE, A., BROWN, S. A., MARCACCI, L., TRONCHE, F., KELLENDONK, C., REICHARDT, H. M., SCHUTZ, G. & SCHIBLER, U. 2000. Resetting of circadian time in peripheral tissues by glucocorticoid signaling. *Science*, 289, 2344-7.
- BALSALOBRE, A., DAMIOLA, F. & SCHIBLER, U. 1998. A serum shock induces circadian gene expression in mammalian tissue culture cells. *Cell*, 93, 929-37.
- BANERJEE, T. D., MIDDLETON, F. & FARAONE, S. V. 2007. Environmental risk factors for attention-deficit hyperactivity disorder. *Acta Paediatr*, 96, 1269-74.
- BANKY, Z., MOLNAR, J., CSERNUS, V. & HALASZ, B. 1988. Further studies on circadian hormone rhythms after local pharmacological destruction of the serotonergic innervation of the rat suprachiasmatic region before the onset of the corticosterone rhythm. *Brain Res*, 445, 222-7.
- BARASSIN, S., RAISON, S., SABOUREAU, M., BIENVENU, C., MAITRE, M., MALAN, A. & PEVET, P. 2002. Circadian tryptophan hydroxylase levels and serotonin release in the suprachiasmatic nucleus of the rat. *Eur J Neurosci*, 15, 833-40.

- BARBINI, B., COLOMBO, C., BENEDETTI, F., CAMPORI, E., BELLODI, L. & SMERALDI, E. 1998. The unipolar-bipolar dichotomy and the response to sleep deprivation. *Psychiatry Res*, 79, 43-50.
- BARKLEY, R. A., EDWARDS, G., LANERI, M., FLETCHER, K. & METEVIA, L. 2001. Executive functioning, temporal discounting, and sense of time in adolescents with attention deficit hyperactivity disorder (ADHD) and oppositional defiant disorder (ODD). *J Abnorm Child Psychol*, 29, 541-56.
- BARKLEY, R. A., FISCHER, M., SMALLISH, L. & FLETCHER, K. 2003. Does the treatment of attention-deficit/hyperactivity disorder with stimulants contribute to drug use/abuse? A 13-year prospective study. *Pediatrics*, 111, 97-109.
- BARNARD, A. R. & NOLAN, P. M. 2008. When clocks go bad: neurobehavioural consequences of disrupted circadian timing. *PLoS Genet*, 4, e1000040.
- BECH, P., CIALDELLA, P., HAUGH, M. C., BIRKETT, M. A., HOURS, A., BOISSEL, J. P. & TOLLEFSON, G. D. 2000. Meta-analysis of randomised controlled trials of fluoxetine v. placebo and tricyclic antidepressants in the short-term treatment of major depression. *Br J Psychiatry*, 176, 421-8.
- BECK-FRIIS, J., KJELLMAN, B. F., APERIA, B., UNDEN, F., VON ROSEN, D., LJUNGGREN, J. G. & WETTERBERG, L. 1985a. Serum melatonin in relation to clinical variables in patients with major depressive disorder and a hypothesis of a low melatonin syndrome. *Acta Psychiatr Scand*, 71, 319-30.
- BECK-FRIIS, J., LJUNGGREN, J. G., THOREN, M., VON ROSEN, D., KJELLMAN, B. F. & WETTERBERG, L. 1985b. Melatonin, cortisol and ACTH in patients with major depressive disorder and healthy humans with special reference to the outcome of the dexamethasone suppression test. *Psychoneuroendocrinology*, 10, 173-86.
- BEELMAN, C. A. & PARKER, R. 1995. Degradation of mRNA in eukaryotes. *Cell*, 81, 179-83.
- BELLINGER, L. L., BERNARDIS, L. L. & MENDEL, V. E. 1976. Effect of ventromedial and dorsomedial hypothalamic lesions on circadian corticosterone rhythms. *Neuroendocrinology*, 22, 216-25.
- BENDZ, L. M. & SCATES, A. C. 2010. Melatonin treatment for insomnia in pediatric patients with attention-deficit/hyperactivity disorder. *Ann Pharmacother*, 44, 185-91.

- BENEDETTI, F., BARBINI, B., CAMPORI, E., FULGOSI, M. C., PONTIGGIA, A. & COLOMBO, C. 2001. Sleep phase advance and lithium to sustain the antidepressant effect of total sleep deprivation in bipolar depression: new findings supporting the internal coincidence model? *J Psychiatr Res*, 35, 323-9.
- BENEDETTI, F., BARBINI, B., COLOMBO, C. & SMERALDI, E. 2007. Chronotherapeutics in a psychiatric ward. *Sleep Med Rev*, 11, 509-22.
- BENEDETTI, F., BARBINI, B., FULGOSI, M. C., COLOMBO, C., DALLASPEZIA, S., PONTIGGIA, A. & SMERALDI, E. 2005. Combined total sleep deprivation and light therapy in the treatment of drug-resistant bipolar depression: acute response and long-term remission rates. *J Clin Psychiatry*, 66, 1535-40.
- BENEDETTI, F., SERRETTI, A., COLOMBO, C., BARBINI, B., LORENZI, C., CAMPORI, E. & SMERALDI, E. 2003. Influence of CLOCK gene polymorphism on circadian mood fluctuation and illness recurrence in bipolar depression. *Am J Med Genet B Neuropsychiatr Genet*, 123B, 23-6.
- BERGER, A. & POSNER, M. I. 2000. Pathologies of brain attentional networks. *Neurosci Biobehav Rev*, 24, 3-5.
- BERNARDIS, L. L. & BELLINGER, L. L. 1998. The dorsomedial hypothalamic nucleus revisited: 1998 update. *Proc Soc Exp Biol Med*, 218, 284-306.
- BIEDERMAN, J. 2005. Attention-deficit/hyperactivity disorder: a selective overview. *Biol Psychiatry*, 57, 1215-20.
- BIEDERMAN, J. & FARAONE, S. V. 2004. The Massachusetts General Hospital studies of gender influences on attention-deficit/hyperactivity disorder in youth and relatives. *Psychiatr Clin North Am*, 27, 225-32.
- BIEDERMAN, J. & FARAONE, S. V. 2005. Attention-deficit hyperactivity disorder. *Lancet*, 366, 237-48.
- BIEDERMAN, J., FARAONE, S. V., KEENAN, K., BENJAMIN, J., KRIFCHER, B., MOORE, C., SPRICH-BUCKMINSTER, S., UGAGLIA, K., JELLINEK, M. S., STEINGARD, R. & ET AL. 1992. Further evidence for family-genetic risk factors in attention deficit hyperactivity disorder. Patterns of comorbidity in probands and relatives psychiatrically and pediatrically referred samples. *Arch Gen Psychiatry*, 49, 728-38.

- BIEDERMAN, J., FARAONE, S. V. & MONUTEAUX, M. C. 2002. Differential effect of environmental adversity by gender: Rutter's index of adversity in a group of boys and girls with and without ADHD. *Am J Psychiatry*, 159, 1556-62.
- BIEDERMAN, J., FARAONE, S. V., SPENCER, T., WILENS, T., NORMAN, D., LAPEY, K. A., MICK, E., LEHMAN, B. K. & DOYLE, A. 1993. Patterns of psychiatric comorbidity, cognition, and psychosocial functioning in adults with attention deficit hyperactivity disorder. *Am J Psychiatry*, 150, 1792-8.
- BIEDERMAN, J., MILBERGER, S., FARAONE, S. V., KIELY, K., GUILTE, J., MICK, E., ABLON, J. S., WARBURTON, R., REED, E. & DAVIS, S. G. 1995. Impact of adversity on functioning and comorbidity in children with attention-deficit hyperactivity disorder. *J Am Acad Child Adolesc Psychiatry*, 34, 1495-503.
- BIEDERMAN, J. & SPENCER, T. 1999. Attention-deficit/hyperactivity disorder (ADHD) as a noradrenergic disorder. *Biol Psychiatry*, 46, 1234-42.
- BIELLO, S. M. & DAFTERS, R. I. 2001. MDMA and fenfluramine alter the response of the circadian clock to a serotonin agonist in vitro. *Brain Res*, 920, 202-9.
- BINGHAM, C., ARBOGAST, B., GUILLAUME, G. C., LEE, J. K. & HALBERG, F. 1982. Inferential statistical methods for estimating and comparing cosinor parameters. *Chronobiologia*, 9, 397-439.
- BIRD, H. R., GOULD, M. S. & STAGHEZZA, B. M. 1993. Patterns of diagnostic comorbidity in a community sample of children aged 9 through 16 years. *J Am Acad Child Adolesc Psychiatry*, 32, 361-8.
- BJARNASON, G. A., JORDAN, R. C. & SOTHERN, R. B. 1999. Circadian variation in the expression of cell-cycle proteins in human oral epithelium. *Am J Pathol*, 154, 613-22.
- BJARNASON, G. A., JORDAN, R. C., WOOD, P. A., LI, Q., LINCOLN, D. W., SOTHERN, R. B., HRUSHESKY, W. J. & BEN-DAVID, Y. 2001. Circadian expression of clock genes in human oral mucosa and skin: association with specific cell-cycle phases. *Am J Pathol*, 158, 1793-801.
- BLOMQVIST, M., HOLMBERG, K., LINDBLAD, F., FERNELL, E., EK, U. & DAHLLOF, G. 2007. Salivary cortisol levels and dental anxiety in children with attention deficit hyperactivity disorder. *Eur J Oral Sci*, 115, 1-6.

- BOBB, A. J., CASTELLANOS, F. X., ADDINGTON, A. M. & RAPOPORT, J. L. 2005. Molecular genetic studies of ADHD: 1991 to 2004. *Am J Med Genet B Neuropsychiatr Genet*, 132B, 109-25.
- BOIVIN, D. B. 2000. Influence of sleep-wake and circadian rhythm disturbances in psychiatric disorders. *J Psychiatry Neurosci*, 25, 446-58.
- BOIVIN, D. B., JAMES, F. O., WU, A., CHO-PARK, P. F., XIONG, H. & SUN, Z. S. 2003. Circadian clock genes oscillate in human peripheral blood mononuclear cells. *Blood*, 102, 4143-5.
- BOKSA, P. & EL-KHODOR, B. F. 2003. Birth insult interacts with stress at adulthood to alter dopaminergic function in animal models: possible implications for schizophrenia and other disorders. *Neurosci Biobehav Rev*, 27, 91-101.
- BONNET, M. H. 1985. Effect of sleep disruption on sleep, performance, and mood. *Sleep*, 8, 11-9.
- BOONSTRA, A. M., KOOIJ, J. J., OOSTERLAAN, J., SERGEANT, J. A., BUITELAAR, J. K. & VAN SOMEREN, E. J. 2007. Hyperactive night and day? Actigraphy studies in adult ADHD: a baseline comparison and the effect of methylphenidate. *Sleep*, 30, 433-42.
- BOTCHKINA, G. I. & MORIN, L. P. 1995. Specialized neuronal and glial contributions to development of the hamster lateral geniculate complex and circadian visual system. *J Neurosci*, 15, 190-201.
- BOYCE, P. & BARRIBALL, E. 2010. Circadian rhythms and depression. *Aust Fam Physician*, 39, 307-10.
- BOYCE, P. M. 1985. 6-Sulphatoxy melatonin in melancholia. *Am J Psychiatry*, 142, 125-7.
- BOYD, T. A., ERNHART, C. B., GREENE, T. H., SOKOL, R. J. & MARTIER, S. 1991. Prenatal alcohol exposure and sustained attention in the preschool years. *Neurotoxicol Teratol*, 13, 49-55.
- BRICARD, C. & BOIDEIN, F. 2001. [Prescribing ritalin in combined modality management of hyperactivity with attention deficit]. *Encephale*, 27, 435-43.
- BROOKES, K. J., MILL, J., GUINDALINI, C., CURRAN, S., XU, X., KNIGHT, J., CHEN, C. K., HUANG, Y. S., SETHNA, V., TAYLOR, E., CHEN, W., BREEN, G. & ASHERSON, P. 2006. A common haplotype of the dopamine transporter gene associated with attention-deficit/hyperactivity disorder and

interacting with maternal use of alcohol during pregnancy. *Arch Gen Psychiatry*, 63, 74-81.

- BROWN, G. M. 1994. Light, melatonin and the sleep-wake cycle. *J Psychiatry Neurosci*, 19, 345-53.
- BROWN, R. T., COLES, C. D., SMITH, I. E., PLATZMAN, K. A., SILVERSTEIN, J., ERICKSON, S. & FALEK, A. 1991. Effects of prenatal alcohol exposure at school age. II. Attention and behavior. *Neurotoxicol Teratol*, 13, 369-76.
- BROWN, S. A., KUNZ, D., DUMAS, A., WESTERMARK, P. O., VANSELOW, K., TILMANN-WAHNSCHAFFE, A., HERZEL, H. & KRAMER, A. 2008. Molecular insights into human daily behavior. *Proc Natl Acad Sci U S A*, 105, 1602-7.
- BROWN, T. E. & MCMULLEN, W. J., JR. 2001. Attention deficit disorders and sleep/arousal disturbance. *Ann N Y Acad Sci*, 931, 271-86.
- BROWN, T. M., COLWELL, C. S., WASCHEK, J. A. & PIGGINS, H. D. 2007. Disrupted neuronal activity rhythms in the suprachiasmatic nuclei of vasoactive intestinal polypeptide-deficient mice. *J Neurophysiol*, 97, 2553-8.
- BROWN, T. M., HUGHES, A. T. & PIGGINS, H. D. 2005. Gastrin-releasing peptide promotes suprachiasmatic nuclei cellular rhythmicity in the absence of vasoactive intestinal polypeptide-VPAC2 receptor signaling. *J Neurosci*, 25, 11155-64.
- BULL, E., REAVILL, C., HAGAN, J. J., OVEREND, P. & JONES, D. N. 2000. Evaluation of the spontaneously hypertensive rat as a model of attention deficit hyperactivity disorder: acquisition and performance of the DRL-60s test. *Behav Brain Res*, 109, 27-35.
- BUNGER, M. K., WILSBACHER, L. D., MORAN, S. M., CLENDENIN, C., RADCLIFFE, L. A., HOGENESCH, J. B., SIMON, M. C., TAKAHASHI, J. S. & BRADFIELD, C. A. 2000. Mop3 is an essential component of the master circadian pacemaker in mammals. *Cell*, 103, 1009-17.
- BUSBY, K., FIRESTONE, P. & PIVIK, R. T. 1981. Sleep patterns in hyperkinetic and normal children. *Sleep*, 4, 366-83.
- BUSTIN, S. A. 2000. Absolute quantification of mRNA using real-time reverse transcription polymerase chain reaction assays. *J Mol Endocrinol*, 25, 169-93.
- BUSTIN, S. A. 2002. Quantification of mRNA using real-time reverse transcription PCR (RT-PCR): trends and problems. *J Mol Endocrinol*, 29, 23-39.

- BUSTIN, S. A., BENES, V., NOLAN, T. & PFAFFL, M. W. 2005. Quantitative real-time RT-PCR--a perspective. *J Mol Endocrinol*, 34, 597-601.
- BYKU, M. & GANNON, R. L. 2000. SNC 80, a delta-opioid agonist, elicits phase advances in hamster circadian activity rhythms. *Neuroreport*, 11, 1449-52.
- BYMASTER, F. P., KATNER, J. S., NELSON, D. L., HEMRICK-LUECKE, S. K., THRELKELD, P. G., HEILIGENSTEIN, J. H., MORIN, S. M., GEHLERT, D. R. & PERRY, K. W. 2002. Atomoxetine increases extracellular levels of norepinephrine and dopamine in prefrontal cortex of rat: a potential mechanism for efficacy in attention deficit/hyperactivity disorder. *Neuropsychopharmacology*, 27, 699-711.
- CAGAMPANG, F. R., OKAMURA, H. & INOUE, S. 1994. Circadian rhythms of norepinephrine in the rat suprachiasmatic nucleus. *Neurosci Lett*, 173, 185-8.
- CAJOCHEN, C., JUD, C., MUNCH, M., KOBIALKA, S., WIRZ-JUSTICE, A. & ALBRECHT, U. 2006. Evening exposure to blue light stimulates the expression of the clock gene PER2 in humans. *Eur J Neurosci*, 23, 1082-6.
- CALDELAS, I., TEJADILLA, D., GONZALEZ, B., MONTUFAR, R. & HUDSON, R. 2007. Diurnal pattern of clock gene expression in the hypothalamus of the newborn rabbit. *Neuroscience*, 144, 395-401.
- CAMPBELL, S. S., GILLIN, J. C., KRIPKE, D. F., JANOWSKY, D. S. & RISCH, S. C. 1989. Lithium delays circadian phase of temperature and REM sleep in a bipolar depressive: a case report. *Psychiatry Res*, 27, 23-9.
- CARD, J. P., BRECHA, N., KARTEN, H. J. & MOORE, R. Y. 1981. Immunocytochemical localization of vasoactive intestinal polypeptide-containing cells and processes in the suprachiasmatic nucleus of the rat: light and electron microscopic analysis. *J Neurosci*, 1, 1289-303.
- CARD, J. P., FITZPATRICK-MCELLIGOTT, S., GOZES, I. & BALDINO, F., JR. 1988. Localization of vasopressin-, vasoactive intestinal polypeptide-, peptide histidine isoleucine- and somatostatin-mRNA in rat suprachiasmatic nucleus. *Cell Tissue Res*, 252, 307-15.
- CARD, J. P. & MOORE, R. Y. 1984. The suprachiasmatic nucleus of the golden hamster: immunohistochemical analysis of cell and fiber distribution. *Neuroscience*, 13, 415-31.

- CARTER, M. E., BORG, J. S. & DE LECEA, L. 2009. The brain hypocretins and their receptors: mediators of allostatic arousal. *Curr Opin Pharmacol*, 9, 39-45.
- CASTANEDA, T. R., DE PRADO, B. M., PRIETO, D. & MORA, F. 2004. Circadian rhythms of dopamine, glutamate and GABA in the striatum and nucleus accumbens of the awake rat: modulation by light. *J Pineal Res*, 36, 177-85.
- CASTELLANOS, F. X. 1997. Toward a pathophysiology of attention-deficit/hyperactivity disorder. *Clin Pediatr (Phila)*, 36, 381-93.
- CASTELLANOS, F. X. & TANNOCK, R. 2002. Neuroscience of attention-deficit/hyperactivity disorder: the search for endophenotypes. *Nat Rev Neurosci*, 3, 617-28.
- CERVANTES, P., GELBER, S., KIN, F. N., NAIR, V. N. & SCHWARTZ, G. 2001. Circadian secretion of cortisol in bipolar disorder. *J Psychiatry Neurosci*, 26, 411-6.
- CHALLET, E., PEVET, P. & MALAN, A. 1996. Intergeniculate leaflet lesion and daily rhythms in food-restricted rats fed during daytime. *Neurosci Lett*, 216, 214-8.
- CHALLET, E., PEVET, P. & MALAN, A. 1997. Lesion of the serotonergic terminals in the suprachiasmatic nuclei limits the phase advance of body temperature rhythm in food-restricted rats fed during daytime. *J Biol Rhythms*, 12, 235-44.
- CHAMBERLAIN, S. R., MULLER, U., CLEARY, S., ROBBINS, T. W. & SAHAKIAN, B. J. 2007a. Atomoxetine increases salivary cortisol in healthy volunteers. *J Psychopharmacol*, 21, 545-9.
- CHAMBERLAIN, S. R., ROBBINS, T. W. & SAHAKIAN, B. J. 2007b. The neurobiology of attention-deficit/hyperactivity disorder. *Biol Psychiatry*, 61, 1317-9.
- CHAUDHURY, D., LOH, D. H., DRAGICH, J. M., HAGOPIAN, A. & COLWELL, C. S. 2008. Select cognitive deficits in vasoactive intestinal peptide deficient mice. *BMC Neurosci*, 9, 63.
- CHEN, D., BUCHANAN, G. F., DING, J. M., HANNIBAL, J. & GILLETTE, M. U. 1999. Pituitary adenylyl cyclase-activating peptide: a pivotal modulator of

- glutamatergic regulation of the suprachiasmatic circadian clock. *Proc Natl Acad Sci U S A*, 96, 13468-73.
- CHEN, W. & BALER, R. 2000. The rat arylalkylamine N-acetyltransferase E-box: differential use in a master vs. a slave oscillator. *Brain Res Mol Brain Res*, 81, 43-50.
- CHERVIN, R. D. 2005. How many children with ADHD have sleep apnea or periodic leg movements on polysomnography? *Sleep*, 28, 1041-2.
- CHERVIN, R. D. & ARCHBOLD, K. H. 2001. Hyperactivity and polysomnographic findings in children evaluated for sleep-disordered breathing. *Sleep*, 24, 313-20.
- CHERVIN, R. D., ARCHBOLD, K. H., DILLON, J. E., PANAHI, P., PITUCH, K. J., DAHL, R. E. & GUILLEMINAULT, C. 2002a. Inattention, hyperactivity, and symptoms of sleep-disordered breathing. *Pediatrics*, 109, 449-56.
- CHERVIN, R. D., ARCHBOLD, K. H., DILLON, J. E., PITUCH, K. J., PANAHI, P., DAHL, R. E. & GUILLEMINAULT, C. 2002b. Associations between symptoms of inattention, hyperactivity, restless legs, and periodic leg movements. *Sleep*, 25, 213-8.
- CHERVIN, R. D., DILLON, J. E., BASSETTI, C., GANOCZY, D. A. & PITUCH, K. J. 1997. Symptoms of sleep disorders, inattention, and hyperactivity in children. *Sleep*, 20, 1185-92.
- CHIANG, H. L., GAU, S. S., NI, H. C., CHIU, Y. N., SHANG, C. Y., WU, Y. Y., LIN, L. Y., TAI, Y. M. & SOONG, W. T. 2010. Association between symptoms and subtypes of attention-deficit hyperactivity disorder and sleep problems/disorders. *J Sleep Res*, 19, 535-45.
- CHONG, N. W., BERNARD, M. & KLEIN, D. C. 2000. Characterization of the chicken serotonin N-acetyltransferase gene. Activation via clock gene heterodimer/E box interaction. *J Biol Chem*, 275, 32991-8.
- CHOU, T. C., SCAMMELL, T. E., GOOLEY, J. J., GAUS, S. E., SAPER, C. B. & LU, J. 2003. Critical role of dorsomedial hypothalamic nucleus in a wide range of behavioral circadian rhythms. *J Neurosci*, 23, 10691-702.
- CHOUINARD, S., POULIN, J., STIP, E. & GODBOUT, R. 2004. Sleep in untreated patients with schizophrenia: a meta-analysis. *Schizophr Bull*, 30, 957-67.

- CHROUSOS, G. P. & GOLD, P. W. 1992. The concepts of stress and stress system disorders. Overview of physical and behavioral homeostasis. *JAMA*, 267, 1244-52.
- CHUDASAMA, Y. & ROBBINS, T. W. 2004. Psychopharmacological approaches to modulating attention in the five-choice serial reaction time task: implications for schizophrenia. *Psychopharmacology (Berl)*, 174, 86-98.
- CLAUSTRAT, B., BRUN, J., DAVID, M., SASSOLAS, G. & CHAZOT, G. 1992. Melatonin and jet lag: confirmatory result using a simplified protocol. *Biol Psychiatry*, 32, 705-11.
- COHEN-ZION, M. & ANCOLI-ISRAEL, S. 2004. Sleep in children with attention-deficit hyperactivity disorder (ADHD): a review of naturalistic and stimulant intervention studies. *Sleep Med Rev*, 8, 379-402.
- COLWELL, C. S., KAUFMAN, C. M. & MENAKER, M. 1993. Phase-shifting mechanisms in the mammalian circadian system: new light on the carbachol paradox. *J Neurosci*, 13, 1454-9.
- COLWELL, C. S. & MENAKER, M. 1992. NMDA as well as non-NMDA receptor antagonists can prevent the phase-shifting effects of light on the circadian system of the golden hamster. *J Biol Rhythms*, 7, 125-36.
- COMINGS, D. E. 2001. Clinical and molecular genetics of ADHD and Tourette syndrome. Two related polygenic disorders. *Ann N Y Acad Sci*, 931, 50-83.
- CONNOR, S. E. & JAROSZ, J. M. 2001. Magnetic resonance imaging of patients with epilepsy. *Clin Radiol*, 56, 787-801.
- COOGAN, A. N., PAPACHATZAKI, M. M., CLEMENS, C., BAIRD, A., DONEV, R. M., JOOSTEN, J., ZACHARIOU, V. & THOME, J. 2011. Haloperidol alters circadian clock gene product expression in the mouse brain. *World J Biol Psychiatry*.
- COOGAN, A. N. & PIGGINS, H. D. 2003. Circadian and photic regulation of phosphorylation of ERK1/2 and Elk-1 in the suprachiasmatic nuclei of the Syrian hamster. *J Neurosci*, 23, 3085-93.
- COOGAN, A. N. & PIGGINS, H. D. 2004. MAP kinases in the mammalian circadian system--key regulators of clock function. *J Neurochem*, 90, 769-75.
- COOK, E. H., JR., STEIN, M. A., KRASOWSKI, M. D., COX, N. J., OLKON, D. M., KIEFFER, J. E. & LEVENTHAL, B. L. 1995. Association of attention-

- deficit disorder and the dopamine transporter gene. *Am J Hum Genet*, 56, 993-8.
- CORKUM, P., TANNOCK, R. & MOLDOFSKY, H. 1998. Sleep disturbances in children with attention-deficit/hyperactivity disorder. *J Am Acad Child Adolesc Psychiatry*, 37, 637-46.
- CRABTREE, V. M., IVANENKO, A., O'BRIEN, L. M. & GOZAL, D. 2003. Periodic limb movement disorder of sleep in children. *J Sleep Res*, 12, 73-81.
- CRASSON, M., KJIRI, S., COLIN, A., KJIRI, K., L'HERMITE-BALERIAUX, M., ANSSEAU, M. & LEGROS, J. J. 2004. Serum melatonin and urinary 6-sulfatoxymelatonin in major depression. *Psychoneuroendocrinology*, 29, 1-12.
- CUESTA, M., CLESSE, D., PEVET, P. & CHALLET, E. 2009. New light on the serotonergic paradox in the rat circadian system. *J Neurochem*, 110, 231-43.
- CURATOLO, P., PALOSCIA, C., D'AGATI, E., MOAVERO, R. & PASINI, A. 2008. The neurobiology of attention deficit/hyperactivity disorder. *Eur J Paediatr Neurol*.
- CUTLER, D. J., HARAURA, M., REED, H. E., SHEN, S., SHEWARD, W. J., MORRISON, C. F., MARSTON, H. M., HARMAR, A. J. & PIGGINS, H. D. 2003. The mouse VPAC2 receptor confers suprachiasmatic nuclei cellular rhythmicity and responsiveness to vasoactive intestinal polypeptide in vitro. *Eur J Neurosci*, 17, 197-204.
- CUTRERA, R. A., KALSBECK, A. & PEVET, P. 1994. Specific destruction of the serotonergic afferents to the suprachiasmatic nuclei prevents triazolam-induced phase advances of hamster activity rhythms. *Behav Brain Res*, 62, 21-8.
- CUTRERA, R. A., SABOUREAU, M. & PEVET, P. 1996. Phase-shifting effect of 8-OH-DPAT, a 5-HT_{1A}/5-HT₇ receptor agonist, on locomotor activity in golden hamster in constant darkness. *Neurosci Lett*, 210, 1-4.
- CZEISLER, C. A., DUFFY, J. F., SHANAHAN, T. L., BROWN, E. N., MITCHELL, J. F., RIMMER, D. W., RONDA, J. M., SILVA, E. J., ALLAN, J. S., EMENS, J. S., DIJK, D. J. & KRONAUER, R. E. 1999. Stability, precision, and near-24-hour period of the human circadian pacemaker. *Science*, 284, 2177-81.

- DAGAN, Y., ZEEVI-LURIA, S., SEVER, Y., HALLIS, D., YOVEL, I., SADEH, A. & DOLEV, E. 1997. Sleep quality in children with attention deficit hyperactivity disorder: an actigraphic study. *Psychiatry Clin Neurosci*, 51, 383-6.
- DALTON, E. J., ROTONDI, D., LEVITAN, R. D., KENNEDY, S. H. & BROWN, G. M. 2000. Use of slow-release melatonin in treatment-resistant depression. *J Psychiatry Neurosci*, 25, 48-52.
- DANE, A. V., SCHACHAR, R. J. & TANNOCK, R. 2000. Does actigraphy differentiate ADHD subtypes in a clinical research setting? *J Am Acad Child Adolesc Psychiatry*, 39, 752-60.
- DAVIS, M. & WHALEN, P. J. 2001. The amygdala: vigilance and emotion. *Mol Psychiatry*, 6, 13-34.
- DAVISS, W. B., BENTIVOGLIO, P., RACUSIN, R., BROWN, K. M., BOSTIC, J. Q. & WILEY, L. 2001. Bupropion sustained release in adolescents with comorbid attention-deficit/hyperactivity disorder and depression. *J Am Acad Child Adolesc Psychiatry*, 40, 307-14.
- DE BODINAT, C., GUARDIOLA-LEMAITRE, B., MOCAER, E., RENARD, P., MUNOZ, C. & MILLAN, M. J. 2010. Agomelatine, the first melatonergic antidepressant: discovery, characterization and development. *Nat Rev Drug Discov*, 9, 628-42.
- DE JEU, M., HERMES, M. & PENNARTZ, C. 1998. Circadian modulation of membrane properties in slices of rat suprachiasmatic nucleus. *Neuroreport*, 9, 3725-9.
- DE VILLIERS, A. S., RUSSELL, V. A., SAGVOLDEN, T., SEARSON, A., JAFFER, A. & TALJAARD, J. J. 1995. Alpha 2-adrenoceptor mediated inhibition of [3H]dopamine release from nucleus accumbens slices and monoamine levels in a rat model for attention-deficit hyperactivity disorder. *Neurochem Res*, 20, 427-33.
- DEBRUYNE, J. P., NOTON, E., LAMBERT, C. M., MAYWOOD, E. S., WEAVER, D. R. & REPERT, S. M. 2006. A clock shock: mouse CLOCK is not required for circadian oscillator function. *Neuron*, 50, 465-77.
- DEBRUYNE, J. P., WEAVER, D. R. & REPERT, S. M. 2007a. CLOCK and NPAS2 have overlapping roles in the suprachiasmatic circadian clock. *Nat Neurosci*, 10, 543-5.

- DEBRUYNE, J. P., WEAVER, D. R. & REPERT, S. M. 2007b. Peripheral circadian oscillators require CLOCK. *Curr Biol*, 17, R538-9.
- DESAN, P. H. & OREN, D. A. 2001. Is seasonal affective disorder a disorder of circadian rhythms? *CNS Spectr*, 6, 487-94, 499-501.
- DESAN, P. H., OREN, D. A., MALISON, R., PRICE, L. H., ROSENBAUM, J., SMOLLER, J., CHARNEY, D. S. & GELERNTER, J. 2000. Genetic polymorphism at the CLOCK gene locus and major depression. *Am J Med Genet*, 96, 418-21.
- DEUSCHLE, M., GOTTHARDT, U., SCHWEIGER, U., WEBER, B., KORNER, A., SCHMIDER, J., STANDHARDT, H., LAMMERS, C. H. & HEUSER, I. 1997. With aging in humans the activity of the hypothalamus-pituitary-adrenal system increases and its diurnal amplitude flattens. *Life Sci*, 61, 2239-46.
- DI CHIARA, G., LODDO, P. & TANDA, G. 1999. Reciprocal changes in prefrontal and limbic dopamine responsiveness to aversive and rewarding stimuli after chronic mild stress: implications for the psychobiology of depression. *Biol Psychiatry*, 46, 1624-33.
- DICKSTEIN, S. G., BANNON, K., CASTELLANOS, F. X. & MILHAM, M. P. 2006. The neural correlates of attention deficit hyperactivity disorder: an ALE meta-analysis. *J Child Psychol Psychiatry*, 47, 1051-62.
- DIJK, D. J. & ARCHER, S. N. 2010. PERIOD3, circadian phenotypes, and sleep homeostasis. *Sleep Med Rev*, 14, 151-60.
- DIJK, D. J., DUFFY, J. F. & CZEISLER, C. A. 1992. Circadian and sleep/wake dependent aspects of subjective alertness and cognitive performance. *J Sleep Res*, 1, 112-7.
- DIMICCO, J. A., SAMUELS, B. C., ZARETSKAIA, M. V. & ZARETSKY, D. V. 2002. The dorsomedial hypothalamus and the response to stress: part renaissance, part revolution. *Pharmacol Biochem Behav*, 71, 469-80.
- DING, J. M., FAIMAN, L. E., HURST, W. J., KURIASHKINA, L. R. & GILLETTE, M. U. 1997. Resetting the biological clock: mediation of nocturnal CREB phosphorylation via light, glutamate, and nitric oxide. *J Neurosci*, 17, 667-75.

- DISNEY, E. R., ELKINS, I. J., MCGUE, M. & IACONO, W. G. 1999. Effects of ADHD, conduct disorder, and gender on substance use and abuse in adolescence. *Am J Psychiatry*, 156, 1515-21.
- DOCKRAY, S. & STEPTOE, A. 2010. Chronotype and diurnal cortisol profile in working women: Differences between work and leisure days. *Psychoneuroendocrinology*.
- DOLBERG, O. T., HIRSCHMANN, S. & GRUNHAUS, L. 1998. Melatonin for the treatment of sleep disturbances in major depressive disorder. *Am J Psychiatry*, 155, 1119-21.
- DOUGHERTY, D. D., BONAB, A. A., SPENCER, T. J., RAUCH, S. L., MADRAS, B. K. & FISCHMAN, A. J. 1999. Dopamine transporter density in patients with attention deficit hyperactivity disorder. *Lancet*, 354, 2132-3.
- DOYLE, R. 2004. The history of adult attention-deficit/hyperactivity disorder. *Psychiatr Clin North Am*, 27, 203-14.
- DRESEL, S., KRAUSE, J., KRAUSE, K. H., LAFOUGERE, C., BRINKBAUMER, K., KUNG, H. F., HAHN, K. & TATSCH, K. 2000. Attention deficit hyperactivity disorder: binding of [^{99m}Tc]TRODAT-1 to the dopamine transporter before and after methylphenidate treatment. *Eur J Nucl Med*, 27, 1518-24.
- DRIEMEL, O., KOSMEHL, H., ROSENHAHN, J., BERNDT, A., REICHERT, T. E., ZARDI, L. & DAHSE, R. 2007. Expression analysis of extracellular matrix components in brush biopsies of oral lesions. *Anticancer Res*, 27, 1565-70.
- DRIJFHOUT, W. J., VAN DER LINDE, A. G., KOOI, S. E., GROL, C. J. & WESTERINK, B. H. 1996. Norepinephrine release in the rat pineal gland: the input from the biological clock measured by in vivo microdialysis. *J Neurochem*, 66, 748-55.
- DUDLEY, C. A., ERBEL-SIELER, C., ESTILL, S. J., REICK, M., FRANKEN, P., PITTS, S. & MCKNIGHT, S. L. 2003. Altered patterns of sleep and behavioral adaptability in NPAS2-deficient mice. *Science*, 301, 379-83.
- DUDLEY, T. E., DINARDO, L. A. & GLASS, J. D. 1998. Endogenous regulation of serotonin release in the hamster suprachiasmatic nucleus. *J Neurosci*, 18, 5045-52.

- DUDLEY, T. E., DINARDO, L. A. & GLASS, J. D. 1999. In vivo assessment of the midbrain raphe nuclear regulation of serotonin release in the hamster suprachiasmatic nucleus. *J Neurophysiol*, 81, 1469-77.
- DUFFY, J. F., RIMMER, D. W. & CZEISLER, C. A. 2001. Association of intrinsic circadian period with morningness-eveningness, usual wake time, and circadian phase. *Behav Neurosci*, 115, 895-9.
- DZIEMA, H., OATIS, B., BUTCHER, G. Q., YATES, R., HOYT, K. R. & OBRIETAN, K. 2003. The ERK/MAP kinase pathway couples light to immediate-early gene expression in the suprachiasmatic nucleus. *Eur J Neurosci*, 17, 1617-27.
- EASTMAN, C. I., YOUNG, M. A., FOGG, L. F., LIU, L. & MEADEN, P. M. 1998. Bright light treatment of winter depression: a placebo-controlled trial. *Arch Gen Psychiatry*, 55, 883-9.
- EASTON, A., ARBUZOVA, J. & TUREK, F. W. 2003. The circadian Clock mutation increases exploratory activity and escape-seeking behavior. *Genes Brain Behav*, 2, 11-9.
- EBLING, F. J. 1996. The role of glutamate in the photic regulation of the suprachiasmatic nucleus. *Prog Neurobiol*, 50, 109-32.
- ELLENBOGEN, J. M., PAYNE, J. D. & STICKGOLD, R. 2006. The role of sleep in declarative memory consolidation: passive, permissive, active or none? *Curr Opin Neurobiol*, 16, 716-22.
- ELMQUIST, J. K., AHIMA, R. S., ELIAS, C. F., FLIER, J. S. & SAPER, C. B. 1998. Leptin activates distinct projections from the dorsomedial and ventromedial hypothalamic nuclei. *Proc Natl Acad Sci U S A*, 95, 741-6.
- EMENS, J., LEWY, A., KINZIE, J. M., ARNTZ, D. & ROUGH, J. 2009. Circadian misalignment in major depressive disorder. *Psychiatry Res*, 168, 259-61.
- EMERSON, K. J., BRADSHAW, W. E. & HOLZAPFEL, C. M. 2008. Concordance of the circadian clock with the environment is necessary to maximize fitness in natural populations. *Evolution*, 62, 979-83.
- ERENBERG, G. 2005. The relationship between tourette syndrome, attention deficit hyperactivity disorder, and stimulant medication: a critical review. *Semin Pediatr Neurol*, 12, 217-21.

- ERNST, M., MOOLCHAN, E. T. & ROBINSON, M. L. 2001. Behavioral and neural consequences of prenatal exposure to nicotine. *J Am Acad Child Adolesc Psychiatry*, 40, 630-41.
- ERNST, M., ZAMETKIN, A. J., MATOCHIK, J. A., JONS, P. H. & COHEN, R. M. 1998. DOPA decarboxylase activity in attention deficit hyperactivity disorder adults. A [fluorine-18]fluorodopa positron emission tomographic study. *J Neurosci*, 18, 5901-7.
- ERNST, M., ZAMETKIN, A. J., MATOCHIK, J. A., PASCUALVACA, D., JONS, P. H. & COHEN, R. M. 1999. High midbrain [18F]DOPA accumulation in children with attention deficit hyperactivity disorder. *Am J Psychiatry*, 156, 1209-15.
- EVENDEN, J. 1999. Impulsivity: a discussion of clinical and experimental findings. *J Psychopharmacol*, 13, 180-92.
- EVERITT, B. J., CARDINAL, R. N., PARKINSON, J. A. & ROBBINS, T. W. 2003. Appetitive behavior: impact of amygdala-dependent mechanisms of emotional learning. *Ann N Y Acad Sci*, 985, 233-50.
- EVERITT, B. J. & WOLF, M. E. 2002. Psychomotor stimulant addiction: a neural systems perspective. *J Neurosci*, 22, 3312-20.
- FARAONE, S. V. 2004. Genetics of adult attention-deficit/hyperactivity disorder. *Psychiatr Clin North Am*, 27, 303-21.
- FARAONE, S. V. & BIEDERMAN, J. 1998. Neurobiology of attention-deficit hyperactivity disorder. *Biol Psychiatry*, 44, 951-8.
- FARAONE, S. V., BIEDERMAN, J. & FRIEDMAN, D. 2000a. Validity of DSM-IV subtypes of attention-deficit/hyperactivity disorder: a family study perspective. *J Am Acad Child Adolesc Psychiatry*, 39, 300-7.
- FARAONE, S. V., BIEDERMAN, J., MICK, E., WILLIAMSON, S., WILENS, T., SPENCER, T., WEBER, W., JETTON, J., KRAUS, I., PERT, J. & ZALLEN, B. 2000b. Family study of girls with attention deficit hyperactivity disorder. *Am J Psychiatry*, 157, 1077-83.
- FARAONE, S. V. & DOYLE, A. E. 2001. The nature and heritability of attention-deficit/hyperactivity disorder. *Child Adolesc Psychiatr Clin N Am*, 10, 299-316, viii-ix.
- FARAONE, S. V. & KHAN, S. A. 2006. Candidate gene studies of attention-deficit/hyperactivity disorder. *J Clin Psychiatry*, 67 Suppl 8, 13-20.

- FARAONE, S. V. & WILENS, T. 2003. Does stimulant treatment lead to substance use disorders? *J Clin Psychiatry*, 64 Suppl 11, 9-13.
- FAYYAD, J., DE GRAAF, R., KESSLER, R., ALONSO, J., ANGERMEYER, M., DEMYTTENAERE, K., DE GIROLAMO, G., HARO, J. M., KARAM, E. G., LARA, C., LEPINE, J. P., ORMEL, J., POSADA-VILLA, J., ZASLAVSKY, A. M. & JIN, R. 2007. Cross-national prevalence and correlates of adult attention-deficit hyperactivity disorder. *Br J Psychiatry*, 190, 402-9.
- FEILLET, C. A., MENDOZA, J., ALBRECHT, U., PEVET, P. & CHALLET, E. 2008. Forebrain oscillators ticking with different clock hands. *Mol Cell Neurosci*, 37, 209-21.
- FELDMAN-NAIM, S., TURNER, E. H. & LEIBENLUFT, E. 1997. Diurnal variation in the direction of mood switches in patients with rapid-cycling bipolar disorder. *J Clin Psychiatry*, 58, 79-84.
- FERGUSON, S. A., ROWE, S. A., KRUPA, M. & KENNAWAY, D. J. 2000. Prenatal exposure to the dopamine agonist SKF-38393 disrupts the timing of the initial response of the suprachiasmatic nucleus to light. *Brain Res*, 858, 284-9.
- FIELD, M. D., MAYWOOD, E. S., O'BRIEN, J. A., WEAVER, D. R., REPERT, S. M. & HASTINGS, M. H. 2000. Analysis of clock proteins in mouse SCN demonstrates phylogenetic divergence of the circadian clockwork and resetting mechanisms. *Neuron*, 25, 437-47.
- FLEIGE, S. & PFAFFL, M. W. 2006. RNA integrity and the effect on the real-time qRT-PCR performance. *Mol Aspects Med*, 27, 126-39.
- FREITAG, C. M., HANIG, S., PALMASON, H., MEYER, J., WUST, S. & SEITZ, C. 2009. Cortisol awakening response in healthy children and children with ADHD: Impact of comorbid disorders and psychosocial risk factors. *Psychoneuroendocrinology*.
- FUKUHARA, C., DIRDEN, J. C. & TOSINI, G. 2000. Circadian expression of period 1, period 2, and arylalkylamine N-acetyltransferase mRNA in the rat pineal gland under different light conditions. *Neurosci Lett*, 286, 167-70.
- FULTON, S., WOODSIDE, B. & SHIZGAL, P. 2000. Modulation of brain reward circuitry by leptin. *Science*, 287, 125-8.

- FUNG, Y. K. & LAU, Y. S. 1989. Effects of prenatal nicotine exposure on rat striatal dopaminergic and nicotinic systems. *Pharmacol Biochem Behav*, 33, 1-6.
- GAU, S. S., KESSLER, R. C., TSENG, W. L., WU, Y. Y., CHIU, Y. N., YEH, C. B. & HWU, H. G. 2007. Association between sleep problems and symptoms of attention-deficit/hyperactivity disorder in young adults. *Sleep*, 30, 195-201.
- GAUB, M. & CARLSON, C. L. 1997. Gender differences in ADHD: a meta-analysis and critical review. *J Am Acad Child Adolesc Psychiatry*, 36, 1036-45.
- GAYTAN, O., LEWIS, C., SWANN, A. & DAFNY, N. 1999. Diurnal differences in amphetamine sensitization. *Eur J Pharmacol*, 374, 1-9.
- GAYTAN, O., YANG, P., SWANN, A. & DAFNY, N. 2000. Diurnal differences in sensitization to methylphenidate. *Brain Res*, 864, 24-39.
- GEHLERT, D. R., GACKENHEIMER, S. L. & ROBERTSON, D. W. 1993. Localization of rat brain binding sites for [3H]tomoxetine, an enantiomerically pure ligand for norepinephrine reuptake sites. *Neurosci Lett*, 157, 203-6.
- GEKAKIS, N., STAKNIS, D., NGUYEN, H. B., DAVIS, F. C., WILSBACHER, L. D., KING, D. P., TAKAHASHI, J. S. & WEITZ, C. J. 1998. Role of the CLOCK protein in the mammalian circadian mechanism. *Science*, 280, 1564-9.
- GERFEN, C. R. 2000. Molecular effects of dopamine on striatal-projection pathways. *Trends Neurosci*, 23, S64-70.
- GERSHON, J. 2002. A meta-analytic review of gender differences in ADHD. *J Atten Disord*, 5, 143-54.
- GIL-AD, I., DICKERMAN, Z., AMDURSKY, S. & LARON, Z. 1986. Diurnal rhythm of plasma beta endorphin, cortisol and growth hormone in schizophrenics as compared to control subjects. *Psychopharmacology (Berl)*, 88, 496-9.
- GILLETTE, M. U. & SEJNOWSKI, T. J. 2005. Physiology. Biological clocks coordinately keep life on time. *Science*, 309, 1196-8.
- GINTY, D. D., KORNHAUSER, J. M., THOMPSON, M. A., BADING, H., MAYO, K. E., TAKAHASHI, J. S. & GREENBERG, M. E. 1993. Regulation of CREB phosphorylation in the suprachiasmatic nucleus by light and a circadian clock. *Science*, 260, 238-41.

- GIORGETTI, M. & TECOTT, L. H. 2004. Contributions of 5-HT(2C) receptors to multiple actions of central serotonin systems. *Eur J Pharmacol*, 488, 1-9.
- GLICKMAN, G., BYRNE, B., PINEDA, C., HAUCK, W. W. & BRAINARD, G. C. 2006. Light therapy for seasonal affective disorder with blue narrow-band light-emitting diodes (LEDs). *Biol Psychiatry*, 59, 502-7.
- GODLER, D. E., LOESCH, D. Z., HUGGINS, R., GORDON, L., SLATER, H. R., GEHLING, F., BURGESS, T. & CHOO, K. H. 2009. Improved methodology for assessment of mRNA levels in blood of patients with FMR1 related disorders. *BMC Clin Pathol*, 9, 5.
- GOEL, N., TERMAN, M., TERMAN, J. S., MACCHI, M. M. & STEWART, J. W. 2005. Controlled trial of bright light and negative air ions for chronic depression. *Psychol Med*, 35, 945-55.
- GOLDEN, R. N., GAYNES, B. N., EKSTROM, R. D., HAMER, R. M., JACOBSEN, F. M., SUPPES, T., WISNER, K. L. & NEMEROFF, C. B. 2005. The efficacy of light therapy in the treatment of mood disorders: a review and meta-analysis of the evidence. *Am J Psychiatry*, 162, 656-62.
- GOLDEN, R. N., MARKEY, S. P., RISBY, E. D., RUDORFER, M. V., COWDRY, R. W. & POTTER, W. Z. 1988. Antidepressants reduce whole-body norepinephrine turnover while enhancing 6-hydroxymelatonin output. *Arch Gen Psychiatry*, 45, 150-4.
- GOLOMBEK, D. A., PEVET, P. & CARDINALI, D. P. 1996. Melatonin effects on behavior: possible mediation by the central GABAergic system. *Neurosci Biobehav Rev*, 20, 403-12.
- GOTTESMANN, C. 1999. Neurophysiological support of consciousness during waking and sleep. *Prog Neurobiol*, 59, 469-508.
- GOUIN, J. P., CONNORS, J., KIECOLT-GLASER, J. K., GLASER, R., MALARKEY, W. B., ATKINSON, C., BEVERSDORF, D. & QUAN, N. 2010. Altered expression of circadian rhythm genes among individuals with a history of depression. *J Affect Disord*, 126, 161-6.
- GOULD, T. D. & MANJI, H. K. 2005. Glycogen synthase kinase-3: a putative molecular target for lithium mimetic drugs. *Neuropsychopharmacology*, 30, 1223-37.

- GOYETTE, C. H., CONNERS, C. K. & ULRICH, R. F. 1978. Normative data on revised Conners Parent and Teacher Rating Scales. *J Abnorm Child Psychol*, 6, 221-36.
- GREEN, D. J. & GILLETTE, R. 1982. Circadian rhythm of firing rate recorded from single cells in the rat suprachiasmatic brain slice. *Brain Res*, 245, 198-200.
- GREENBERG, M. E., THOMPSON, M. A. & SHENG, M. 1992. Calcium regulation of immediate early gene transcription. *J Physiol Paris*, 86, 99-108.
- GREENHILL, L., PUIG-ANTICH, J., GOETZ, R., HANLON, C. & DAVIES, M. 1983. Sleep architecture and REM sleep measures in prepubertal children with attention deficit disorder with hyperactivity. *Sleep*, 6, 91-101.
- GROEGER, J. A., VIOLA, A. U., LO, J. C., VON SCHANTZ, M., ARCHER, S. N. & DIJK, D. J. 2008. Early morning executive functioning during sleep deprivation is compromised by a PERIOD3 polymorphism. *Sleep*, 31, 1159-67.
- GROOS, G. & HENDRIKS, J. 1982. Circadian rhythms in electrical discharge of rat suprachiasmatic neurones recorded in vitro. *Neurosci Lett*, 34, 283-8.
- GROSSMAN, G. H., MISTLBERGER, R. E., ANTLE, M. C., EHLEN, J. C. & GLASS, J. D. 2000. Sleep deprivation stimulates serotonin release in the suprachiasmatic nucleus. *Neuroreport*, 11, 1929-32.
- GRUBER, R., SADEH, A. & RAVIV, A. 2000. Instability of sleep patterns in children with attention-deficit/hyperactivity disorder. *J Am Acad Child Adolesc Psychiatry*, 39, 495-501.
- GUILDING, C. & PIGGINS, H. D. 2007. Challenging the omnipotence of the suprachiasmatic timekeeper: are circadian oscillators present throughout the mammalian brain? *Eur J Neurosci*, 25, 3195-216.
- GUNDUZ-BRUCE, H., SZESZKO, P. R., GUEORGUIEVA, R., ASHTARI, M., ROBINSON, D. G., KANE, J. M. & BILDER, R. M. 2007. Cortisol levels in relation to hippocampal sub-regions in subjects with first episode schizophrenia. *Schizophr Res*, 94, 281-7.
- HABA-RUBIO, J. 2005. Psychiatric aspects of organic sleep disorders. *Dialogues Clin Neurosci*, 7, 335-46.
- HACK, M., YOUNGSTROM, E. A., CARTAR, L., SCHLUCHTER, M., TAYLOR, H. G., FLANNERY, D., KLEIN, N. & BORAWSKI, E. 2004. Behavioral

- outcomes and evidence of psychopathology among very low birth weight infants at age 20 years. *Pediatrics*, 114, 932-40.
- HAIMOV, I. & LAVIE, P. 1995. Potential of melatonin replacement therapy in older patients with sleep disorders. *Drugs Aging*, 7, 75-8.
- HAIMOV, I., LAVIE, P., LAUDON, M., HERER, P., VIGDER, C. & ZISAPEL, N. 1995. Melatonin replacement therapy of elderly insomniacs. *Sleep*, 18, 598-603.
- HALBREICH, U., ASNIS, G. M., SHINDLEDECKER, R., ZUMOFF, B. & NATHAN, R. S. 1985. Cortisol secretion in endogenous depression. II. Time-related functions. *Arch Gen Psychiatry*, 42, 909-14.
- HALLAM, K. T., OLVER, J. S., HORGAN, J. E., MCGRATH, C. & NORMAN, T. R. 2005. Low doses of lithium carbonate reduce melatonin light sensitivity in healthy volunteers. *Int J Neuropsychopharmacol*, 8, 255-9.
- HALMOY, A., JOHANSSON, S., WINGE, I., MCKINNEY, J. A., KNAPPSKOG, P. M. & HAAVIK, J. 2010. Attention-deficit/hyperactivity disorder symptoms in offspring of mothers with impaired serotonin production. *Arch Gen Psychiatry*, 67, 1033-43.
- HAMADA, T., ANTLE, M. C. & SILVER, R. 2004. Temporal and spatial expression patterns of canonical clock genes and clock-controlled genes in the suprachiasmatic nucleus. *Eur J Neurosci*, 19, 1741-8.
- HAMADA, T., LESAUTER, J., VENUTI, J. M. & SILVER, R. 2001. Expression of Period genes: rhythmic and nonrhythmic compartments of the suprachiasmatic nucleus pacemaker. *J Neurosci*, 21, 7742-50.
- HAMADA, T., YAMANOUCHI, S., WATANABE, A., SHIBATA, S. & WATANABE, S. 1999. Involvement of glutamate release in substance P-induced phase delays of suprachiasmatic neuron activity rhythm in vitro. *Brain Res*, 836, 190-3.
- HAMET, P. & TREMBLAY, J. 2006. Genetics of the sleep-wake cycle and its disorders. *Metabolism*, 55, S7-12.
- HAMPP, G., RIPPERGER, J. A., HOUBEN, T., SCHMUTZ, I., BLEX, C., PERREAU-LENZ, S., BRUNK, I., SPANAGEL, R., AHNERT-HILGER, G., MEIJER, J. H. & ALBRECHT, U. 2008. Regulation of monoamine oxidase A by circadian-clock components implies clock influence on mood. *Curr Biol*, 18, 678-83.

- HANNA, G. L., ORNITZ, E. M. & HARIHARAN, M. 1996. Urinary epinephrine excretion during intelligence testing in attention-deficit hyperactivity disorder and normal boys. *Biol Psychiatry*, 40, 553-5.
- HARVEY, A. G. 2008. Sleep and circadian rhythms in bipolar disorder: seeking synchrony, harmony, and regulation. *Am J Psychiatry*, 165, 820-9.
- HASTINGS, M. & MAYWOOD, E. S. 2000. Circadian clocks in the mammalian brain. *Bioessays*, 22, 23-31.
- HASTINGS, M. H. & HERZOG, E. D. 2004. Clock genes, oscillators, and cellular networks in the suprachiasmatic nuclei. *J Biol Rhythms*, 19, 400-13.
- HASTINGS, M. H., MAYWOOD, E. S. & REDDY, A. B. 2008. Two decades of circadian time. *J Neuroendocrinol*, 20, 812-9.
- HASTINGS, P. D., FORTIER, I., UTENDALE, W. T., SIMARD, L. R. & ROBAEY, P. 2009. Adrenocortical Functioning in Boys with Attention-Deficit/Hyperactivity Disorder: Examining Subtypes of ADHD and Associated Comorbid Conditions. *J Abnorm Child Psychol*.
- HATTORI, J., OGINO, T., ABIRU, K., NAKANO, K., OKA, M. & OHTSUKA, Y. 2006. Are pervasive developmental disorders and attention-deficit/hyperactivity disorder distinct disorders? *Brain Dev*, 28, 371-4.
- HATZINGER, M., BRAND, S., PERREN, S., VON WYL, A., VON KLITZING, K. & HOLSBOER-TRACHSLER, E. 2007. Hypothalamic-pituitary-adrenocortical (HPA) activity in kindergarten children: importance of gender and associations with behavioral/emotional difficulties. *J Psychiatr Res*, 41, 861-70.
- HAUG, H. J., WIRZ-JUSTICE, A. & ROSSLER, W. 2000. Actigraphy to measure day structure as a therapeutic variable in the treatment of schizophrenic patients. *Acta Psychiatr Scand Suppl*, 91-5.
- HAVERMANS, R., NICOLSON, N. A., BERKHOF, J. & DEVRIES, M. W. 2010. Patterns of salivary cortisol secretion and responses to daily events in patients with remitted bipolar disorder. *Psychoneuroendocrinology*.
- HEIMER, L., ZAHM, D. S., CHURCHILL, L., KALIVAS, P. W. & WOHLTMANN, C. 1991. Specificity in the projection patterns of accumbal core and shell in the rat. *Neuroscience*, 41, 89-125.

- HEMPEL, R. J., TULEN, J. H., VAN BEVEREN, N. J., RODER, C. H., DE JONG, F. H. & HENGEVELD, M. W. 2010. Diurnal cortisol patterns of young male patients with schizophrenia. *Psychiatry Clin Neurosci*, 64, 548-54.
- HERZOG, E. D. & MUGLIA, L. J. 2006. You are when you eat. *Nat Neurosci*, 9, 300-2.
- HIROTA, T. & FUKADA, Y. 2004. Resetting mechanism of central and peripheral circadian clocks in mammals. *Zoolog Sci*, 21, 359-68.
- HIRVIKOSKI, T., LINDHOLM, T., NORDENSTROM, A., NORDSTROM, A. L. & LAJIC, S. 2009. High self-perceived stress and many stressors, but normal diurnal cortisol rhythm, in adults with ADHD (attention-deficit/hyperactivity disorder). *Horm Behav*, 55, 418-24.
- HOFFMAN, A. E., YI, C. H., ZHENG, T., STEVENS, R. G., LEADERER, D., ZHANG, Y., HOLFORD, T. R., HANSEN, J., PAULSON, J. & ZHU, Y. 2010. CLOCK in breast tumorigenesis: genetic, epigenetic, and transcriptional profiling analyses. *Cancer Res*, 70, 1459-68.
- HOFSTETTER, J. R., MAYEDA, A. R., POSSIDENTE, B. & NURNBERGER, J. I., JR. 1995. Quantitative trait loci (QTL) for circadian rhythms of locomotor activity in mice. *Behav Genet*, 25, 545-56.
- HOH, S. T., GREENFIELD, D. S., MISTLBERGER, A., LIEBMANN, J. M., ISHIKAWA, H. & RITCH, R. 2000. Optical coherence tomography and scanning laser polarimetry in normal, ocular hypertensive, and glaucomatous eyes. *Am J Ophthalmol*, 129, 129-35.
- HOLMES, M. M. & MISTLBERGER, R. E. 2000. Food anticipatory activity and photic entrainment in food-restricted BALB/c mice. *Physiol Behav*, 68, 655-66.
- HONG, H. J., SHIN, D. W., LEE, E. H., OH, Y. H. & NOH, K. S. 2003. Hypothalamic-pituitary-adrenal reactivity in boys with attention deficit hyperactivity disorder. *Yonsei Med J*, 44, 608-14.
- HONMA, K. & HONMA, S. 2009. The SCN-independent clocks, methamphetamine and food restriction. *Eur J Neurosci*, 30, 1707-17.
- HONMA, K., HONMA, S. & HIROSHIGE, T. 1986. Disorganization of the rat activity rhythm by chronic treatment with methamphetamine. *Physiol Behav*, 38, 687-95.

- HONMA, S. & HONMA, K. 1992. Locomotor rhythms induced by methylphenidate in suprachiasmatic nuclei-lesioned rats. *Neurosci Lett*, 137, 24-8.
- HONMA, S. & HONMA, K. 1995. Phase-dependent phase shift of methamphetamine-induced circadian rhythm by haloperidol in SCN-lesioned rats. *Brain Res*, 674, 283-90.
- HONMA, S., HONMA, K., SHIRAKAWA, T. & HIROSHIGE, T. 1988. Rhythms in behaviors, body temperature and plasma corticosterone in SCN lesioned rats given methamphetamine. *Physiol Behav*, 44, 247-55.
- HONMA, S., KAWAMOTO, T., TAKAGI, Y., FUJIMOTO, K., SATO, F., NOSHIRO, M., KATO, Y. & HONMA, K. 2002. Dec1 and Dec2 are regulators of the mammalian molecular clock. *Nature*, 419, 841-4.
- HONMA, S., YASUDA, T., YASUI, A., VAN DER HORST, G. T. & HONMA, K. 2008. Circadian behavioral rhythms in Cry1/Cry2 double-deficient mice induced by methamphetamine. *J Biol Rhythms*, 23, 91-4.
- HONRADO, G. I., JOHNSON, R. S., GOLOMBEK, D. A., SPIEGELMAN, B. M., PAPAIOANNOU, V. E. & RALPH, M. R. 1996. The circadian system of c-fos deficient mice. *J Comp Physiol A*, 178, 563-70.
- HOOD, S., CASSIDY, P., COSSETTE, M. P., WEIGL, Y., VERWEY, M., ROBINSON, B., STEWART, J. & AMIR, S. 2010. Endogenous dopamine regulates the rhythm of expression of the clock protein PER2 in the rat dorsal striatum via daily activation of D2 dopamine receptors. *J Neurosci*, 30, 14046-58.
- HORNE, J. A. & OSTBERG, O. 1977. Individual differences in human circadian rhythms. *Biol Psychol*, 5, 179-90.
- HSU, R., TAYLOR, J. R., NEWTON, S. S., ALVARO, J. D., HAILE, C., HAN, G., HRUBY, V. J., NESTLER, E. J. & DUMAN, R. S. 2005. Blockade of melanocortin transmission inhibits cocaine reward. *Eur J Neurosci*, 21, 2233-42.
- HUIZINK, A. C. & MULDER, E. J. 2006. Maternal smoking, drinking or cannabis use during pregnancy and neurobehavioral and cognitive functioning in human offspring. *Neurosci Biobehav Rev*, 30, 24-41.
- HUNT, A. E., AL-GHOUL, W. M., GILLETTE, M. U. & DUBOCOVICH, M. L. 2001. Activation of MT(2) melatonin receptors in rat suprachiasmatic nucleus phase advances the circadian clock. *Am J Physiol Cell Physiol*, 280, C110-8.

- HYMAN, S. E. & MALENKA, R. C. 2001. Addiction and the brain: the neurobiology of compulsion and its persistence. *Nat Rev Neurosci*, 2, 695-703.
- IJIMA, M., NIKAIDO, T., AKIYAMA, M., MORIYA, T. & SHIBATA, S. 2002. Methamphetamine-induced, suprachiasmatic nucleus-independent circadian rhythms of activity and mPer gene expression in the striatum of the mouse. *Eur J Neurosci*, 16, 921-9.
- IITAKA, C., MIYAZAKI, K., AKAIKE, T. & ISHIDA, N. 2005. A role for glycogen synthase kinase-3beta in the mammalian circadian clock. *J Biol Chem*, 280, 29397-402.
- IMBEAUD, S., GRAUDENS, E., BOULANGER, V., BARLET, X., ZABORSKI, P., EVENO, E., MUELLER, O., SCHROEDER, A. & AUFRAY, C. 2005. Towards standardization of RNA quality assessment using user-independent classifiers of microcapillary electrophoresis traces. *Nucleic Acids Res*, 33, e56.
- IMBESI, M., YILDIZ, S., DIRIM ARSLAN, A., SHARMA, R., MANEV, H. & UZ, T. 2009. Dopamine receptor-mediated regulation of neuronal "clock" gene expression. *Neuroscience*, 158, 537-44.
- INDREDAVIK, M. S., VIK, T., HEYERDAHL, S., KULSENG, S., FAYERS, P. & BRUBAKK, A. M. 2004. Psychiatric symptoms and disorders in adolescents with low birth weight. *Arch Dis Child Fetal Neonatal Ed*, 89, F445-50.
- INGRAM, C. D., SNOWBALL, R. K. & MIHAI, R. 1996. Circadian rhythm of neuronal activity in suprachiasmatic nucleus slices from the vasopressin-deficient Brattleboro rat. *Neuroscience*, 75, 635-41.
- INOUE, S. T. & KAWAMURA, H. 1979. Persistence of circadian rhythmicity in a mammalian hypothalamic "island" containing the suprachiasmatic nucleus. *Proc Natl Acad Sci U S A*, 76, 5962-6.
- IRONSIDE, S., DAVIDSON, F. & CORKUM, P. 2010. Circadian motor activity affected by stimulant medication in children with attention-deficit/hyperactivity disorder. *J Sleep Res*.
- IRWIN, M. R., WANG, M., CAMPOMAYOR, C. O., COLLADO-HIDALGO, A. & COLE, S. 2006. Sleep deprivation and activation of morning levels of cellular and genomic markers of inflammation. *Arch Intern Med*, 166, 1756-62.

- ISHIDA, Y., YAGITA, K., FUKUYAMA, T., NISHIMURA, M., NAGANO, M., SHIGEYOSHI, Y., YAMAGUCHI, S., KOMORI, T. & OKAMURA, H. 2001. Constitutive expression and delayed light response of casein kinase Iepsilon and Idelta mRNAs in the mouse suprachiasmatic nucleus. *J Neurosci Res*, 64, 612-6.
- ISOBE, Y. & NISHINO, H. 2001. Circadian rhythm of drinking and running-wheel activity in rats with 6-hydroxydopamine lesions of the ventral tegmental area. *Brain Res*, 899, 187-92.
- JIANG, H. K. & WANG, J. Y. 1998. Diurnal melatonin and cortisol secretion profiles in medicated schizophrenic patients. *J Formos Med Assoc*, 97, 830-7.
- JILG, A., LESNY, S., PERUZKI, N., SCHWEGLER, H., SELBACH, O., DEHGHANI, F. & STEHLE, J. H. 2010. Temporal dynamics of mouse hippocampal clock gene expression support memory processing. *Hippocampus*, 20, 377-88.
- JIMENEZ-CAPDEVILLE, M. E. & DYKES, R. W. 1993. Daily changes in the release of acetylcholine from rat primary somatosensory cortex. *Brain Res*, 625, 152-8.
- JOCKERS, R., MAURICE, P., BOUTIN, J. A. & DELAGRANGE, P. 2008. Melatonin receptors, heterodimerization, signal transduction and binding sites: what's new? *Br J Pharmacol*, 154, 1182-95.
- JOHANSSON, C., WILLEIT, M., SMEDH, C., EKHOLM, J., PAUNIO, T., KIESEPPA, T., LICHTERMANN, D., PRASCHAK-RIEDER, N., NEUMEISTER, A., NILSSON, L. G., KASPER, S., PELTONEN, L., ADOLFSSON, R., SCHALLING, M. & PARTONEN, T. 2003. Circadian clock-related polymorphisms in seasonal affective disorder and their relevance to diurnal preference. *Neuropsychopharmacology*, 28, 734-9.
- JONES, B. E. 1991. The role of noradrenergic locus coeruleus neurons and neighboring cholinergic neurons of the pontomesencephalic tegmentum in sleep-wake states. *Prog Brain Res*, 88, 533-43.
- JONES, D. E. & FOSTER, E. M. 2009. Service use patterns for adolescents with ADHD and comorbid conduct disorder. *J Behav Health Serv Res*, 36, 436-49.
- JONES, S. H., HARE, D. J. & EVERSHED, K. 2005. Actigraphic assessment of circadian activity and sleep patterns in bipolar disorder. *Bipolar Disord*, 7, 176-86.

- fJOYCE, P. R., DONALD, R. A., NICHOLLS, M. G., LIVESEY, J. H. & ABBOTT, R. M. 1986. Endocrine and behavioral responses to methylphenidate in normal subjects. *Biol Psychiatry*, 21, 1015-23.
- JUD, C., CHAPPUIS, S., REVELL, V. L., SLETTEN, T. L., SAALTINK, D. J., CAJOCHEN, C., SKENE, D. J. & ALBRECHT, U. 2009. Age-dependent alterations in human PER2 levels after early morning blue light exposure. *Chronobiol Int*, 26, 1462-9.
- KADESJO, B. & GILLBERG, C. 2001. The comorbidity of ADHD in the general population of Swedish school-age children. *J Child Psychol Psychiatry*, 42, 487-92.
- KAHN, R. S., KHOURY, J., NICHOLS, W. C. & LANPHEAR, B. P. 2003. Role of dopamine transporter genotype and maternal prenatal smoking in childhood hyperactive-impulsive, inattentive, and oppositional behaviors. *J Pediatr*, 143, 104-10.
- KALADCHIBACHI, S. A., DOBLE, B., ANTHOPOULOS, N., WOODGETT, J. R. & MANOUKIAN, A. S. 2007. Glycogen synthase kinase 3, circadian rhythms, and bipolar disorder: a molecular link in the therapeutic action of lithium. *J Circadian Rhythms*, 5, 3.
- KALIVAS, P. W. 2004. Glutamate systems in cocaine addiction. *Curr Opin Pharmacol*, 4, 23-9.
- KALMAN, B. A. & SPENCER, R. L. 2002. Rapid corticosteroid-dependent regulation of mineralocorticoid receptor protein expression in rat brain. *Endocrinology*, 143, 4184-95.
- KALSBECK, A., DRIJFHOUT, W. J., WESTERINK, B. H., VAN HEERIKHUIZE, J. J., VAN DER WOUDE, T. P., VAN DER VLIET, J. & BUIJS, R. M. 1996. GABA receptors in the region of the dorsomedial hypothalamus of rats are implicated in the control of melatonin and corticosterone release. *Neuroendocrinology*, 63, 69-78.
- KAMETANI, H. & KAWAMURA, H. 1991. Circadian rhythm of cortical acetylcholine release as measured by in vivo microdialysis in freely moving rats. *Neurosci Lett*, 132, 263-6.
- KAMPHUIS, W., CAILOTTO, C., DIJK, F., BERGEN, A. & BUIJS, R. M. 2005. Circadian expression of clock genes and clock-controlled genes in the rat retina. *Biochem Biophys Res Commun*, 330, 18-26.

- KANEKO, M., HOSHINO, Y., HASHIMOTO, S., OKANO, T. & KUMASHIRO, H. 1993. Hypothalamic-pituitary-adrenal axis function in children with attention-deficit hyperactivity disorder. *J Autism Dev Disord*, 23, 59-65.
- KARIYAWASAM, S. H., ZAW, F. & HANDLEY, S. L. 2002. Reduced salivary cortisol in children with comorbid Attention deficit hyperactivity disorder and oppositional defiant disorder. *Neuro Endocrinol Lett*, 23, 45-8.
- KASPER, S., HAJAK, G., WULFF, K., HOOGENDIJK, W. J., MONTEJO, A. L., SMERALDI, E., RYBAKOWSKI, J. K., QUERA-SALVA, M. A., WIRZ-JUSTICE, A. M., PICAREL-BLANCHOT, F. & BAYLE, F. J. 2010. Efficacy of the novel antidepressant agomelatine on the circadian rest-activity cycle and depressive and anxiety symptoms in patients with major depressive disorder: a randomized, double-blind comparison with sertraline. *J Clin Psychiatry*, 71, 109-20.
- KASPER, S. & HAMON, M. 2009. Beyond the monoaminergic hypothesis: agomelatine, a new antidepressant with an innovative mechanism of action. *World J Biol Psychiatry*, 10, 117-26.
- KATZENBERG, D., YOUNG, T., FINN, L., LIN, L., KING, D. P., TAKAHASHI, J. S. & MIGNOT, E. 1998. A CLOCK polymorphism associated with human diurnal preference. *Sleep*, 21, 569-76.
- KELLER, J., FLORES, B., GOMEZ, R. G., SOLVASON, H. B., KENNA, H., WILLIAMS, G. H. & SCHATZBERG, A. F. 2006. Cortisol circadian rhythm alterations in psychotic major depression. *Biol Psychiatry*, 60, 275-81.
- KELLEY, A. E. & BERRIDGE, K. C. 2002. The neuroscience of natural rewards: relevance to addictive drugs. *J Neurosci*, 22, 3306-11.
- KEMALI, D., MAJ, M., ARIANO, M. G., ARENA, F. & LOVERO, N. 1985. 24-hour plasma levels of prolactin, cortisol, growth hormone and catecholamines in schizophrenic patients. *Neuropsychobiology*, 14, 109-14.
- KENNAWAY, D. J. & MOYER, R. W. 1998. Serotonin 5-HT_{2c} agonists mimic the effect of light pulses on circadian rhythms. *Brain Res*, 806, 257-70.
- KENNEDY, S. H. & EMSLEY, R. 2006. Placebo-controlled trial of agomelatine in the treatment of major depressive disorder. *Eur Neuropsychopharmacol*, 16, 93-100.
- KENNEDY, S. H., RIZVI, S., FULTON, K. & RASMUSSEN, J. 2008. A double-blind comparison of sexual functioning, antidepressant efficacy, and

tolerability between agomelatine and venlafaxine XR. *J Clin Psychopharmacol*, 28, 329-33.

- KENT, J. D., BLADER, J. C., KOPLEWICZ, H. S., ABIKOFF, H. & FOLEY, C. A. 1995. Effects of late-afternoon methylphenidate administration on behavior and sleep in attention-deficit hyperactivity disorder. *Pediatrics*, 96, 320-5.
- KHALSA, S. B. S., JEWETT, M. E., DUFFY, J. F. & CZEISLER, C. A. 2000. The timing of the human circadian clock is accurately represented by the core body temperature rhythm following phase shifts to a three-cycle light stimulus near the critical zone. *J Biol Rhythms*, 15, 524-30.
- KIEFER, F. & WIEDEMANN, K. 2004. Neuroendocrine pathways of addictive behaviour. *Addict Biol*, 9, 205-12.
- KIM, B. N., KIM, J. W., HONG, S. B., CHO, S. C., SHIN, M. S. & YOO, H. J. 2010. Possible association of norepinephrine transporter -3081(A/T) polymorphism with methylphenidate response in attention deficit hyperactivity disorder. *Behav Brain Funct*, 6, 57.
- KIM, C. H., HAHN, M. K., JOUNG, Y., ANDERSON, S. L., STEELE, A. H., MAZEI-ROBINSON, M. S., GIZER, I., TEICHER, M. H., COHEN, B. M., ROBERTSON, D., WALDMAN, I. D., BLAKELY, R. D. & KIM, K. S. 2006. A polymorphism in the norepinephrine transporter gene alters promoter activity and is associated with attention-deficit hyperactivity disorder. *Proc Natl Acad Sci U S A*, 103, 19164-9.
- KING, J. A., BARKLEY, R. A. & BARRETT, S. 1998. Attention-deficit hyperactivity disorder and the stress response. *Biol Psychiatry*, 44, 72-4.
- KING, V. M., CHAHAD-EHLERS, S., SHEN, S., HARMAR, A. J., MAYWOOD, E. S. & HASTINGS, M. H. 2003. A hVIPR transgene as a novel tool for the analysis of circadian function in the mouse suprachiasmatic nucleus. *Eur J Neurosci*, 17, 822-32.
- KIRLEY, A., LOWE, N., HAWI, Z., MULLINS, C., DALY, G., WALDMAN, I., MCCARRON, M., O'DONNELL, D., FITZGERALD, M. & GILL, M. 2003. Association of the 480 bp DAT1 allele with methylphenidate response in a sample of Irish children with ADHD. *Am J Med Genet B Neuropsychiatr Genet*, 121B, 50-4.
- KIROV, R., BANASCHEWSKI, T., UEBEL, H., KINKELBUR, J. & ROTHENBERGER, A. 2007. REM-sleep alterations in children with co-

- existence of tic disorders and attention-deficit/hyperactivity disorder: impact of hypermotor symptoms. *Eur Child Adolesc Psychiatry*, 16 Suppl 1, 45-50.
- KIROV, R., KINKELBUR, J., HEIPKE, S., KOSTANECKA-ENDRESS, T., WESTHOFF, M., COHRS, S., RUTHER, E., HAJAK, G., BANASCHEWSKI, T. & ROTHENBERGER, A. 2004. Is there a specific polysomnographic sleep pattern in children with attention deficit/hyperactivity disorder? *J Sleep Res*, 13, 87-93.
- KISSLING, C., RETZ, W., WIEMANN, S., COOGAN, A. N., CLEMENT, R. M., HUNNERKOPF, R., CONNER, A. C., FREITAG, C. M., ROSLER, M. & THOME, J. 2008. A polymorphism at the 3'-untranslated region of the CLOCK gene is associated with adult attention-deficit hyperactivity disorder. *Am J Med Genet B Neuropsychiatr Genet*, 147, 333-8.
- KLEIN, D. C., SMOOT, R., WELLER, J. L., HIGA, S., MARKEY, S. P., CREED, G. J. & JACOBOWITZ, D. M. 1983. Lesions of the paraventricular nucleus area of the hypothalamus disrupt the suprachiasmatic leads to spinal cord circuit in the melatonin rhythm generating system. *Brain Res Bull*, 10, 647-52.
- KLERMAN, E. B., BOULOS, Z., EDGAR, D. M., MISTLBERGER, R. E. & MOORE-EDE, M. C. 2000. EEG delta activity during undisturbed sleep in the squirrel monkey. *Sleep Res Online*, 3, 113-9.
- KOBINGER 1978. Central alpha-adrenergic systems as targets for hypotensive drugs. *Rev Physiol Biochem Pharmacol*, 81, 39-100.
- KOBINGER, W. 1981. The role of alpha-adrenoceptors in central nervous and peripheral vascular regulation. *Jpn J Pharmacol*, 31 Suppl, 13P-20P.
- KODA, K., AGO, Y., CONG, Y., KITA, Y., TAKUMA, K. & MATSUDA, T. 2010. Effects of acute and chronic administration of atomoxetine and methylphenidate on extracellular levels of noradrenaline, dopamine and serotonin in the prefrontal cortex and striatum of mice. *J Neurochem*, 114, 259-70.
- KOOB, G. F. & LE MOAL, M. 2001. Drug addiction, dysregulation of reward, and allostasis. *Neuropsychopharmacology*, 24, 97-129.
- KORNHAUSER, J. M., MAYO, K. E. & TAKAHASHI, J. S. 1996. Light, immediate-early genes, and circadian rhythms. *Behav Genet*, 26, 221-40.

- KRAUSE, K. H., DRESEL, S. H., KRAUSE, J., KUNG, H. F. & TATSCH, K. 2000. Increased striatal dopamine transporter in adult patients with attention deficit hyperactivity disorder: effects of methylphenidate as measured by single photon emission computed tomography. *Neurosci Lett*, 285, 107-10.
- KRAUSE, K. H., DRESEL, S. H., KRAUSE, J., KUNG, H. F., TATSCH, K. & ACKENHEIL, M. 2002. Stimulant-like action of nicotine on striatal dopamine transporter in the brain of adults with attention deficit hyperactivity disorder. *Int J Neuropsychopharmacol*, 5, 111-3.
- KUCZENSKI, R. & SEGAL, D. S. 2002. Exposure of adolescent rats to oral methylphenidate: preferential effects on extracellular norepinephrine and absence of sensitization and cross-sensitization to methamphetamine. *J Neurosci*, 22, 7264-71.
- KUDIELKA, B. M., FEDERENKO, I. S., HELLHAMMER, D. H. & WUST, S. 2006. Morningness and eveningness: the free cortisol rise after awakening in "early birds" and "night owls". *Biol Psychol*, 72, 141-6.
- KUHNE, M., SCHACHAR, R. & TANNOCK, R. 1997. Impact of comorbid oppositional or conduct problems on attention-deficit hyperactivity disorder. *J Am Acad Child Adolesc Psychiatry*, 36, 1715-25.
- KUME, K., ZYLKA, M. J., SRIRAM, S., SHEARMAN, L. P., WEAVER, D. R., JIN, X., MAYWOOD, E. S., HASTINGS, M. H. & REPERT, S. M. 1999. mCRY1 and mCRY2 are essential components of the negative limb of the circadian clock feedback loop. *Cell*, 98, 193-205.
- KUO, T. B., SHAW, F. Z., LAI, C. J., LAI, C. W. & YANG, C. C. 2004. Changes in sleep patterns in spontaneously hypertensive rats. *Sleep*, 27, 406-12.
- KUPFER, D. J. & FOSTER, F. G. 1972. Interval between onset of sleep and rapid-eye-movement sleep as an indicator of depression. *Lancet*, 2, 684-6.
- LACKSCHEWITZ, H., HUTHER, G. & KRONER-HERWIG, B. 2008. Physiological and psychological stress responses in adults with attention-deficit/hyperactivity disorder (ADHD). *Psychoneuroendocrinology*, 33, 612-24.
- LAHEY, B. B., LOEBER, R., BURKE, J., RATHOUZ, P. J. & MCBURNETT, K. 2002. Waxing and waning in concert: dynamic comorbidity of conduct disorder with other disruptive and emotional problems over 7 years among clinic-referred boys. *J Abnorm Psychol*, 111, 556-67.

- LAKIN-THOMAS, P. L. 2006. Transcriptional feedback oscillators: maybe, maybe not. *J Biol Rhythms*, 21, 83-92.
- LAKIN-THOMAS, P. L., BRODY, S. & COTE, G. G. 1991. Amplitude model for the effects of mutations and temperature on period and phase resetting of the *Neurospora* circadian oscillator. *J Biol Rhythms*, 6, 281-97.
- LAMONT, E. W., COUTU, D. L., CERMAKIAN, N. & BOIVIN, D. B. 2010. Circadian rhythms and clock genes in psychotic disorders. *Isr J Psychiatry Relat Sci*, 47, 27-35.
- LAMONT, E. W., ROBINSON, B., STEWART, J. & AMIR, S. 2005. The central and basolateral nuclei of the amygdala exhibit opposite diurnal rhythms of expression of the clock protein Period2. *Proc Natl Acad Sci USA*, 102, 4180-4.
- LAPOSKY, A., EASTON, A., DUGOVIC, C., WALISSER, J., BRADFIELD, C. & TUREK, F. 2005. Deletion of the mammalian circadian clock gene BMAL1/Mop3 alters baseline sleep architecture and the response to sleep deprivation. *Sleep*, 28, 395-409.
- LAVEBRATT, C., SJOHOLM, L. K., PARTONEN, T., SCHALLING, M. & FORSELL, Y. 2010a. PER2 variantion is associated with depression vulnerability. *Am J Med Genet B Neuropsychiatr Genet*, 153B, 570-81.
- LAVEBRATT, C., SJOHOLM, L. K., SORONEN, P., PAUNIO, T., VAWTER, M. P., BUNNEY, W. E., ADOLFSSON, R., FORSELL, Y., WU, J. C., KELSOE, J. R., PARTONEN, T. & SCHALLING, M. 2010b. CRY2 is associated with depression. *PLoS One*, 5, e9407.
- LAVKER, R. M., DONG, G., CHENG, S. Z., KUDOH, K., COTSARELIS, G. & SUN, T. T. 1991. Relative proliferative rates of limbal and corneal epithelia. Implications of corneal epithelial migration, circadian rhythm, and suprabasally located DNA-synthesizing keratinocytes. *Invest Ophthalmol Vis Sci*, 32, 1864-75.
- LEDOUX, J. E. 2000. Emotion circuits in the brain. *Annu Rev Neurosci*, 23, 155-84.
- LEE, H. S., NELMS, J. L., NGUYEN, M., SILVER, R. & LEHMAN, M. N. 2003. The eye is necessary for a circadian rhythm in the suprachiasmatic nucleus. *Nat Neurosci*, 6, 111-2.

- LEE, M. J., YANG, P. B., WILCOX, V. T., BURAU, K. D., SWANN, A. C. & DAFNY, N. 2010. Repetitive methylphenidate administration modulates the diurnal behavioral activity pattern of adult female SD rats. *J Neural Transm.*
- LEE, M. S., YANG, J. W., KO, Y. H., HAN, C., KIM, S. H., JOE, S. H. & JUNG, I. K. 2008. Effects of methylphenidate and bupropion on DHEA-S and cortisol plasma levels in attention-deficit hyperactivity disorder. *Child Psychiatry Hum Dev*, 39, 201-9.
- LEHMAN, M. N., SILVER, R., GLADSTONE, W. R., KAHN, R. M., GIBSON, M. & BITTMAN, E. L. 1987. Circadian rhythmicity restored by neural transplant. Immunocytochemical characterization of the graft and its integration with the host brain. *J Neurosci*, 7, 1626-38.
- LEIBENLUFT, E., ALBERT, P. S., ROSENTHAL, N. E. & WEHR, T. A. 1996. Relationship between sleep and mood in patients with rapid-cycling bipolar disorder. *Psychiatry Res*, 63, 161-8.
- LEIBENLUFT, E., TURNER, E. H., FELDMAN-NAIM, S., SCHWARTZ, P. J., WEHR, T. A. & ROSENTHAL, N. E. 1995. Light therapy in patients with rapid cycling bipolar disorder: preliminary results. *Psychopharmacol Bull*, 31, 705-10.
- LEIBENLUFT, E. & WEHR, T. A. 1992. Is sleep deprivation useful in the treatment of depression? *Am J Psychiatry*, 149, 159-68.
- LEMOINE, P., GUILLEMINAULT, C. & ALVAREZ, E. 2007. Improvement in subjective sleep in major depressive disorder with a novel antidepressant, agomelatine: randomized, double-blind comparison with venlafaxine. *J Clin Psychiatry*, 68, 1723-32.
- LEO, D., SORRENTINO, E., VOLPICELLI, F., EYMAN, M., GRECO, D., VIGGIANO, D., DI PORZIO, U. & PERRONE-CAPANO, C. 2003. Altered midbrain dopaminergic neurotransmission during development in an animal model of ADHD. *Neurosci Biobehav Rev*, 27, 661-9.
- LESAUTER, J. & SILVER, R. 1993. Lithium lengthens the period of circadian rhythms in lesioned hamsters bearing SCN grafts. *Biol Psychiatry*, 34, 75-83.
- LEVITAN, R. D., JAIN, U. R. & KATZMAN, M. A. 1999. Seasonal affective symptoms in adults with residual attention-deficit hyperactivity disorder. *Compr Psychiatry*, 40, 261-7.

- LEWY, A. J., BAUER, V. K., CUTLER, N. L., SACK, R. L., AHMED, S., THOMAS, K. H., BLOOD, M. L. & JACKSON, J. M. 1998. Morning vs evening light treatment of patients with winter depression. *Arch Gen Psychiatry*, 55, 890-6.
- LEWY, A. J., SACK, R. L., MILLER, L. S. & HOBAN, T. M. 1987a. Antidepressant and circadian phase-shifting effects of light. *Science*, 235, 352-4.
- LEWY, A. J., SACK, R. L., SINGER, C. M. & WHITE, D. M. 1987b. The phase shift hypothesis for bright light's therapeutic mechanism of action: theoretical considerations and experimental evidence. *Psychopharmacol Bull*, 23, 349-53.
- LI, S. X., LIU, L. J., JIANG, W. G. & LU, L. 2009a. Morphine withdrawal produces circadian rhythm alterations of clock genes in mesolimbic brain areas and peripheral blood mononuclear cells in rats. *J Neurochem*, 109, 1668-79.
- LI, S. X., SHI, J., EPSTEIN, D. H., WANG, X., ZHANG, X. L., BAO, Y. P., ZHANG, D., ZHANG, X. Y., KOSTEN, T. R. & LU, L. 2009b. Circadian alteration in neurobiology during 30 days of abstinence in heroin users. *Biol Psychiatry*, 65, 905-12.
- LIM, C. G., OOI, Y. P., FUNG, D. S., MAHENDRAN, R. & KAUR, A. 2008. Sleep disturbances in Singaporean children with attention deficit hyperactivity disorder. *Ann Acad Med Singapore*, 37, 655-61.
- LIN, L., FARACO, J., LI, R., KADOTANI, H., ROGERS, W., LIN, X., QIU, X., DE JONG, P. J., NISHINO, S. & MIGNOT, E. 1999. The sleep disorder canine narcolepsy is caused by a mutation in the hypocretin (orexin) receptor 2 gene. *Cell*, 98, 365-76.
- LINKOWSKI, P., KERKHOFS, M., VAN ONDERBERGEN, A., HUBAIN, P., COPINSCHI, G., L'HERMITE-BALERIAUX, M., LECLERCQ, R., BRASSEUR, M., MENDLEWICZ, J. & VAN CAUTER, E. 1994. The 24-hour profiles of cortisol, prolactin, and growth hormone secretion in mania. *Arch Gen Psychiatry*, 51, 616-24.
- LIU, S. Y., SHIBATA, S. & UEKI, S. 1986. Effect of monoamines on field potentials in the suprachiasmatic nucleus of slices of hypothalamus of the rat evoked by stimulation of the optic nerve. *Neuropharmacology*, 25, 1009-14.

- LITTNER, M., HIRSHKOWITZ, M., KRAMER, M., KAPEN, S., ANDERSON, W. M., BAILEY, D., BERRY, R. B., DAVILA, D., JOHNSON, S., KUSHIDA, C., LOUBE, D. I., WISE, M. & WOODSON, B. T. 2003a. Practice parameters for using polysomnography to evaluate insomnia: an update. *Sleep*, 26, 754-60.
- LITTNER, M., KUSHIDA, C. A., ANDERSON, W. M., BAILEY, D., BERRY, R. B., DAVILA, D. G., HIRSHKOWITZ, M., KAPEN, S., KRAMER, M., LOUBE, D., WISE, M. & JOHNSON, S. F. 2003b. Practice parameters for the role of actigraphy in the study of sleep and circadian rhythms: an update for 2002. *Sleep*, 26, 337-41.
- LIU, C. & REPPERT, S. M. 2000. GABA synchronizes clock cells within the suprachiasmatic circadian clock. *Neuron*, 25, 123-8.
- LIU, C., WEAVER, D. R., JIN, X., SHEARMAN, L. P., PIESCHL, R. L., GRIBKOFF, V. K. & REPPERT, S. M. 1997. Molecular dissection of two distinct actions of melatonin on the suprachiasmatic circadian clock. *Neuron*, 19, 91-102.
- LIVAK, K. J. & SCHMITTGEN, T. D. 2001. Analysis of relative gene expression data using real-time quantitative PCR and the 2(-Delta Delta C(T)) Method. *Methods*, 25, 402-8.
- LOPEZ-MOLINA, L., CONQUET, F., DUBOIS-DAUPHIN, M. & SCHIBLER, U. 1997. The DBP gene is expressed according to a circadian rhythm in the suprachiasmatic nucleus and influences circadian behavior. *EMBO J*, 16, 6762-71.
- LOWE, N., KIRLEY, A., HAWI, Z., SHAM, P., WICKHAM, H., KRATOCHVIL, C. J., SMITH, S. D., LEE, S. Y., LEVY, F., KENT, L., MIDDLE, F., ROHDE, L. A., ROMAN, T., TAHIR, E., YAZGAN, Y., ASHERSON, P., MILL, J., THAPAR, A., PAYTON, A., TODD, R. D., STEPHENS, T., EBSTEIN, R. P., MANOR, I., BARR, C. L., WIGG, K. G., SINKE, R. J., BUITELAAR, J. K., SMALLEY, S. L., NELSON, S. F., BIEDERMAN, J., FARAONE, S. V. & GILL, M. 2004. Joint analysis of the DRD5 marker concludes association with attention-deficit/hyperactivity disorder confined to the predominantly inattentive and combined subtypes. *Am J Hum Genet*, 74, 348-56.

- LUDOLPH, A. G., KASSUBEK, J., SCHMECK, K., GLASER, C., WUNDERLICH, A., BUCK, A. K., RESKE, S. N., FEGERT, J. M. & MOTTAGHY, F. M. 2008a. Dopaminergic dysfunction in attention deficit hyperactivity disorder (ADHD), differences between pharmacologically treated and never treated young adults: a 3,4-dihydroxy-6-[18F]fluorophenyl-l-alanine PET study. *Neuroimage*, 41, 718-27.
- LUDOLPH, A. G., PINKHARDT, E. H., TEBARTZ VAN ELST, L., LIBAL, G., LUDOLPH, A. C., FEGERT, J. M. & KASSUBEK, J. 2008b. Are amygdalar volume alterations in children with Tourette syndrome due to ADHD comorbidity? *Dev Med Child Neurol*, 50, 524-9.
- LUO, A. H. & ASTON-JONES, G. 2009. Circuit projection from suprachiasmatic nucleus to ventral tegmental area: a novel circadian output pathway. *Eur J Neurosci*, 29, 748-60.
- LUPBERGER, J., KREUZER, K. A., BASKAYNAK, G., PETERS, U. R., LE COUTRE, P. & SCHMIDT, C. A. 2002. Quantitative analysis of beta-actin, beta-2-microglobulin and porphobilinogen deaminase mRNA and their comparison as control transcripts for RT-PCR. *Mol Cell Probes*, 16, 25-30.
- LUTEIJN, E. F., SERRA, M., JACKSON, S., STEENHUIS, M. P., ALTHAUS, M., VOLKMAR, F. & MINDERAA, R. 2000. How unspecified are disorders of children with a pervasive developmental disorder not otherwise specified? A study of social problems in children with PDD-NOS and ADHD. *Eur Child Adolesc Psychiatry*, 9, 168-79.
- MACCHI, M. M. & BRUCE, J. N. 2004. Human pineal physiology and functional significance of melatonin. *Front Neuroendocrinol*, 25, 177-95.
- MACFARLANE, J. G., CLEGHORN, J. M., BROWN, G. M. & STREINER, D. L. 1991. The effects of exogenous melatonin on the total sleep time and daytime alertness of chronic insomniacs: a preliminary study. *Biol Psychiatry*, 30, 371-6.
- MADJIROVA, N. P., PETROVA, N. S. & DELCHEV, N. K. 1995. Daily rhythmicity of temperature, pulse and blood pressure in schizophrenic patients. *Schizophr Res*, 14, 183.
- MADRAS, B. K., MILLER, G. M. & FISCHMAN, A. J. 2005. The dopamine transporter and attention-deficit/hyperactivity disorder. *Biol Psychiatry*, 57, 1397-409.

- MALLICK, B. N., MAJUMDAR, S., FAISAL, M., YADAV, V., MADAN, V. & PAL, D. 2002. Role of norepinephrine in the regulation of rapid eye movement sleep. *J Biosci*, 27, 539-51.
- MANSOUR, H. A., WOOD, J., CHOWDARI, K. V., DAYAL, M., THASE, M. E., KUPFER, D. J., MONK, T. H., DEVLIN, B. & NIMGAONKAR, V. L. 2005. Circadian phase variation in bipolar I disorder. *Chronobiol Int*, 22, 571-84.
- MANSOUR, H. A., WOOD, J., LOGUE, T., CHOWDARI, K. V., DAYAL, M., KUPFER, D. J., MONK, T. H., DEVLIN, B. & NIMGAONKAR, V. L. 2006. Association study of eight circadian genes with bipolar I disorder, schizoaffective disorder and schizophrenia. *Genes Brain Behav*, 5, 150-7.
- MANSUR, N. R., MEYER-SIEGLER, K., WURZER, J. C. & SIROVER, M. A. 1993. Cell cycle regulation of the glyceraldehyde-3-phosphate dehydrogenase/uracil DNA glycosylase gene in normal human cells. *Nucleic Acids Res*, 21, 993-8.
- MARQUEZ DE PRADO, B., CASTANEDA, T. R., GALINDO, A., DEL ARCO, A., SEGOVIA, G., REITER, R. J. & MORA, F. 2000. Melatonin disrupts circadian rhythms of glutamate and GABA in the neostriatum of the aware rat: a microdialysis study. *J Pineal Res*, 29, 209-16.
- MASON, R. 1986. Circadian variation in sensitivity of suprachiasmatic and lateral geniculate neurones to 5-hydroxytryptamine in the rat. *J Physiol*, 377, 1-13.
- MASSELLO, W., 3RD & CARPENTER, D. A. 1999. A fatality due to the intranasal abuse of methylphenidate (Ritalin). *J Forensic Sci*, 44, 220-1.
- MASUBUCHI, S., HONMA, S., ABE, H., ISHIZAKI, K., NAMIHIRA, M., IKEDA, M. & HONMA, K. 2000. Clock genes outside the suprachiasmatic nucleus involved in manifestation of locomotor activity rhythm in rats. *Eur J Neurosci*, 12, 4206-14.
- MASUBUCHI, S., HONMA, S., ABE, H., NAKAMURA, W. & HONMA, K. 2001. Circadian activity rhythm in methamphetamine-treated Clock mutant mice. *Eur J Neurosci*, 14, 1177-80.
- MATZA, L. S., PARAMORE, C. & PRASAD, M. 2005. A review of the economic burden of ADHD. *Cost Eff Resour Alloc*, 3, 5.
- MAYES, S. D., CALHOUN, S. L., BIXLER, E. O., VGONTZAS, A. N., MAHR, F., HILLWIG-GARCIA, J., ELAMIR, B., EDHERE-EKEZIE, L. & PARVIN,

- M. 2009. ADHD subtypes and comorbid anxiety, depression, and oppositional-defiant disorder: differences in sleep problems. *J Pediatr Psychol*, 34, 328-37.
- MAYWOOD, E. S., REDDY, A. B., WONG, G. K., O'NEILL, J. S., O'BRIEN, J. A., MCMAHON, D. G., HARMAR, A. J., OKAMURA, H. & HASTINGS, M. H. 2006. Synchronization and maintenance of timekeeping in suprachiasmatic circadian clock cells by neuropeptidergic signaling. *Curr Biol*, 16, 599-605.
- MCCLUNG, C. A. 2007. Circadian genes, rhythms and the biology of mood disorders. *Pharmacol Ther*, 114, 222-32.
- MCCLUNG, C. A., SIDIROPOULOU, K., VITATERNA, M., TAKAHASHI, J. S., WHITE, F. J., COOPER, D. C. & NESTLER, E. J. 2005. Regulation of dopaminergic transmission and cocaine reward by the Clock gene. *Proc Natl Acad Sci USA*, 102, 9377-81.
- MCGOUGH, J. J. & BARKLEY, R. A. 2004. Diagnostic controversies in adult attention deficit hyperactivity disorder. *Am J Psychiatry*, 161, 1948-56.
- MCGOUGH, J.J., SMALLEY, S.L., MCCRACKEN, J.T., YANG, M., DELHOMME, M., LYNN, D.E. & LOO, S. 2005. Psychiatric Comorbidity in Adult Attention Deficit Hyperactivity Disorder: Findings From Multiplex Families. *Am J Psychiatry*, 162, 1621-1627.
- MCKAY, K. E. & HALPERIN, J. M. 2001. ADHD, aggression, and antisocial behavior across the lifespan. Interactions with neurochemical and cognitive function. *Ann N Y Acad Sci*, 931, 84-96.
- MEDANIC, M. & GILLETTE, M. U. 1992. Serotonin regulates the phase of the rat suprachiasmatic circadian pacemaker in vitro only during the subjective day. *J Physiol*, 450, 629-42.
- MEIJER, J. H., WATANABE, K., SCHAAP, J., ALBUS, H. & DETARI, L. 1998. Light responsiveness of the suprachiasmatic nucleus: long-term multiunit and single-unit recordings in freely moving rats. *J Neurosci*, 18, 9078-87.
- MENG, Q. J., LOGUNOVA, L., MAYWOOD, E. S., GALLEGGO, M., LEBIECKI, J., BROWN, T. M., SLADEK, M., SEMIKHODSKII, A. S., GLOSSOP, N. R., PIGGINS, H. D., CHESHAM, J. E., BECHTOLD, D. A., YOO, S. H., TAKAHASHI, J. S., VIRSHUP, D. M., BOOT-HANDFORD, R. P., HASTINGS, M. H. & LOUDON, A. S. 2008. Setting clock speed in

mammals: the CK1 epsilon tau mutation in mice accelerates circadian pacemakers by selectively destabilizing PERIOD proteins. *Neuron*, 58, 78-88.

- MEYER-BERNSTEIN, E. L., JETTON, A. E., MATSUMOTO, S. I., MARKUNS, J. F., LEHMAN, M. N. & BITTMAN, E. L. 1999. Effects of suprachiasmatic transplants on circadian rhythms of neuroendocrine function in golden hamsters. *Endocrinology*, 140, 207-18.
- MIANO, S., DONFRANCESCO, R., BRUNI, O., FERRI, R., GALIFFA, S., PAGANI, J., MONTEMITRO, E., KHEIRANDISH, L., GOZAL, D. & PIA VILLA, M. 2006. NREM sleep instability is reduced in children with attention-deficit/hyperactivity disorder. *Sleep*, 29, 797-803.
- MICHELSON, D., ADLER, L., SPENCER, T., REIMHERR, F. W., WEST, S. A., ALLEN, A. J., KELSEY, D., WERNICKE, J., DIETRICH, A. & MILTON, D. 2003. Atomoxetine in adults with ADHD: two randomized, placebo-controlled studies. *Biol Psychiatry*, 53, 112-20.
- MICK, E., BIEDERMAN, J., PRINCE, J., FISCHER, M. J. & FARAONE, S. V. 2002. Impact of low birth weight on attention-deficit hyperactivity disorder. *J Dev Behav Pediatr*, 23, 16-22.
- MIGNOT, E. 2004. Sleep, sleep disorders and hypocretin (orexin). *Sleep Med*, 5 Suppl 1, S2-8.
- MIHAI, R., COCULESCU, M., WAKERLEY, J. B. & INGRAM, C. D. 1994. The effects of [Arg8]vasopressin and [Arg8]vasotocin on the firing rate of suprachiasmatic neurons in vitro. *Neuroscience*, 62, 783-92.
- MILL, J., SAGVOLDEN, T. & ASHERSON, P. 2005. Sequence analysis of *Drd2*, *Drd4*, and *Dat1* in SHR and WKY rat strains. *Behav Brain Funct*, 1, 24.
- MILLAN, M. J. 2005. Serotonin 5-HT_{2C} receptors as a target for the treatment of depressive and anxious states: focus on novel therapeutic strategies. *Therapie*, 60, 441-60.
- MISHIMA, K., TOZAWA, T., SATOH, K., SAITOH, H. & MISHIMA, Y. 2005. The 3111T/C polymorphism of *hClock* is associated with evening preference and delayed sleep timing in a Japanese population sample. *Am J Med Genet B Neuropsychiatr Genet*, 133B, 101-4.

- MISTLBERGER, R. E. & HOLMES, M. M. 2000. Behavioral feedback regulation of circadian rhythm phase angle in light-dark entrained mice. *Am J Physiol Regul Integr Comp Physiol*, 279, R813-21.
- MITCHELL, H. A. & WEINSHENKER, D. 2010. Good night and good luck: norepinephrine in sleep pharmacology. *Biochem Pharmacol*, 79, 801-9.
- MITSUBISHI, D., MIZUNO, T. & KIMURA, F. 1996. Age-related changes in diurnal acetylcholine release in the prefrontal cortex of male rats as measured by microdialysis. *Neuroscience*, 72, 429-34.
- MIYAKE, A., FRIEDMAN, N. P., EMERSON, M. J., WITZKI, A. H., HOWERTER, A. & WAGER, T. D. 2000. The unity and diversity of executive functions and their contributions to complex "Frontal Lobe" tasks: a latent variable analysis. *Cogn Psychol*, 41, 49-100.
- MODESTIN, J., MATUTAT, B. & WURMLE, O. 2001. Antecedents of opioid dependence and personality disorder: attention-deficit/hyperactivity disorder and conduct disorder. *Eur Arch Psychiatry Clin Neurosci*, 251, 42-7.
- MOHAWK, J. A., BAER, M. L. & MENAKER, M. 2009. The methamphetamine-sensitive circadian oscillator does not employ canonical clock genes. *Proc Natl Acad Sci U S A*, 106, 3519-24.
- MOJON, A., FERNANDEZ, J. R. & HERMIDA, R. C. 1992. Chronolab: an interactive software package for chronobiologic time series analysis written for the Macintosh computer. *Chronobiol Int*, 9, 403-12.
- MOLL, G. H., HEINRICH, H., TROTT, G., WIRTH, S. & ROTHENBERGER, A. 2000. Deficient intracortical inhibition in drug-naive children with attention-deficit hyperactivity disorder is enhanced by methylphenidate. *Neurosci Lett*, 284, 121-5.
- MOLL, G. H., HEINRICH, H., TROTT, G. E., WIRTH, S., BOCK, N. & ROTHENBERGER, A. 2001. Children with comorbid attention-deficit-hyperactivity disorder and tic disorder: evidence for additive inhibitory deficits within the motor system. *Ann Neurol*, 49, 393-6.
- MONTELEONE, P., MAJ, M., FUSCO, M., KEMALI, D. & REITER, R. J. 1992. Depressed nocturnal plasma melatonin levels in drug-free paranoid schizophrenics. *Schizophr Res*, 7, 77-84.
- MOORE, R. Y. & EICHLER, V. B. 1972. Loss of a circadian adrenal corticosterone rhythm following suprachiasmatic lesions in the rat. *Brain Res*, 42, 201-6.

- MOORE, R. Y. & SPEH, J. C. 1993. GABA is the principal neurotransmitter of the circadian system. *Neurosci Lett*, 150, 112-6.
- MOORE, R. Y., SPEH, J. C. & CARD, J. P. 1995. The retinohypothalamic tract originates from a distinct subset of retinal ganglion cells. *J Comp Neurol*, 352, 351-66.
- MORGAN, P. J., BARRETT, P., HOWELL, H. E. & HELLIWELL, R. 1994. Melatonin receptors: localization, molecular pharmacology and physiological significance. *Neurochem Int*, 24, 101-46.
- MORIN, L. P. & ALLEN, C. N. 2006. The circadian visual system, 2005. *Brain Res Rev*, 51, 1-60.
- MORIN, L. P. & BLANCHARD, J. 1991. Depletion of brain serotonin by 5,7-DHT modifies hamster circadian rhythm response to light. *Brain Res*, 566, 173-85.
- MORIYA, T., FUKUSHIMA, T., SHIMAZOE, T., SHIBATA, S. & WATANABE, S. 1996. Chronic administration of methamphetamine does not affect the suprachiasmatic nucleus-operated circadian pacemaker in rats. *Neurosci Lett*, 208, 129-32.
- MOSS, H. B., VANYUKOV, M. M. & MARTIN, C. S. 1995. Salivary cortisol responses and the risk for substance abuse in prepubertal boys. *Biol Psychiatry*, 38, 547-55.
- MULLIGAN, A., ANNEY, R. J., O'REGAN, M., CHEN, W., BUTLER, L., FITZGERALD, M., BUITELAAR, J., STEINHAUSEN, H. C., ROTHENBERGER, A., MINDERAA, R., NIJMEIJER, J., HOEKSTRA, P. J., OADES, R. D., ROEYERS, H., BUSCHGENS, C., CHRISTIANSEN, H., FRANKE, B., GABRIELS, I., HARTMAN, C., KUNTSI, J., MARCO, R., MEIDAD, S., MUELLER, U., PSYCHOGIOU, L., ROMMELSE, N., THOMPSON, M., UEBEL, H., BANASCHEWSKI, T., EBSTEIN, R., EISENBERG, J., MANOR, I., MIRANDA, A., MULAS, F., SERGEANT, J., SONUGA-BARKE, E., ASHERSON, P., FARAONE, S. V. & GILL, M. 2009. Autism symptoms in Attention-Deficit/Hyperactivity Disorder: a familial trait which correlates with conduct, oppositional defiant, language and motor disorders. *J Autism Dev Disord*, 39, 197-209.
- MURPHY, K. R., BARKLEY, R. A. & BUSH, T. 2002. Young adults with attention deficit hyperactivity disorder: subtype differences in comorbidity, educational, and clinical history. *J Nerv Ment Dis*, 190, 147-57.

- MUZUR, A., PACE-SCHOTT, E. F. & HOBSON, J. A. 2002. The prefrontal cortex in sleep. *Trends Cogn Sci*, 6, 475-481.
- NEDIC, G., PIVAC, N., HERCIGONJA, D. K., JOVANCEVIC, M., CURKOVIC, K. D. & MUCK-SELER, D. 2010. Platelet monoamine oxidase activity in children with attention-deficit/hyperactivity disorder. *Psychiatry Res*, 175, 252-5.
- NESTLER, E. J. 2001. Molecular basis of long-term plasticity underlying addiction. *Nat Rev Neurosci*, 2, 119-28.
- NESTLER, E. J. & CARLEZON, W. A., JR. 2006. The mesolimbic dopamine reward circuit in depression. *Biol Psychiatry*, 59, 1151-9.
- NEUBAUER, A.C. 1992. Psychometric comparison of two circadian rhythm questionnaires and their relationship with Personality. *Person Individ Diff*, 13, 125-131.
- NEUMAN, R. J., LOBOS, E., REICH, W., HENDERSON, C. A., SUN, L. W. & TODD, R. D. 2007. Prenatal smoking exposure and dopaminergic genotypes interact to cause a severe ADHD subtype. *Biol Psychiatry*, 61, 1320-8.
- NEVES, S. N. & REIMAO, R. 2007. Sleep disturbances in 50 children with attention-deficit hyperactivity disorder. *Arq Neuropsiquiatr*, 65, 228-33.
- NIBUYA, M., NESTLER, E. J. & DUMAN, R. S. 1996. Chronic antidepressant administration increases the expression of cAMP response element binding protein (CREB) in rat hippocampus. *J Neurosci*, 16, 2365-72.
- NICOLA, S. M., TAHA, S. A., KIM, S. W. & FIELDS, H. L. 2005. Nucleus accumbens dopamine release is necessary and sufficient to promote the behavioral response to reward-predictive cues. *Neuroscience*, 135, 1025-33.
- NICULESCU, A. B., 3RD, SEGAL, D. S., KUCZENSKI, R., BARRETT, T., HAUGER, R. L. & KELSOE, J. R. 2000. Identifying a series of candidate genes for mania and psychosis: a convergent functional genomics approach. *Physiol Genomics*, 4, 83-91.
- NIEVERGELT, C. M., KRIPKE, D. F., BARRETT, T. B., BURG, E., REMICK, R. A., SADOVNICK, A. D., MCELROY, S. L., KECK, P. E., JR., SCHORK, N. J. & KELSOE, J. R. 2006. Suggestive evidence for association of the circadian genes PERIOD3 and ARNTL with bipolar disorder. *Am J Med Genet B Neuropsychiatr Genet*, 141B, 234-41.

- NISHINO, H. & KOIZUMI, K. 1977. Responses of neurons in the suprachiasmatic nuclei of the hypothalamus to putative transmitters. *Brain Res*, 120, 167-72.
- NOSHIRO, M., USUI, E., KAWAMOTO, T., KUBO, H., FUJIMOTO, K., FURUKAWA, M., HONMA, S., MAKISHIMA, M., HONMA, K. & KATO, Y. 2007. Multiple mechanisms regulate circadian expression of the gene for cholesterol 7 α -hydroxylase (Cyp7a), a key enzyme in hepatic bile acid biosynthesis. *J Biol Rhythms*, 22, 299-311.
- O'BRIEN, L. M., HOLBROOK, C. R., MERVIS, C. B., KLAUS, C. J., BRUNER, J. L., RAFFIELD, T. J., RUTHERFORD, J., MEHL, R. C., WANG, M., TUELL, A., HUME, B. C. & GOZAL, D. 2003a. Sleep and neurobehavioral characteristics of 5- to 7-year-old children with parentally reported symptoms of attention-deficit/hyperactivity disorder. *Pediatrics*, 111, 554-63.
- O'BRIEN, L. M., IVANENKO, A., CRABTREE, V. M., HOLBROOK, C. R., BRUNER, J. L., KLAUS, C. J. & GOZAL, D. 2003b. Sleep disturbances in children with attention deficit hyperactivity disorder. *Pediatr Res*, 54, 237-43.
- OBRIETAN, K., IMPEY, S. & STORM, D. R. 1998. Light and circadian rhythmicity regulate MAP kinase activation in the suprachiasmatic nuclei. *Nat Neurosci*, 1, 693-700.
- OGDEN, C. A., RICH, M. E., SCHORK, N. J., PAULUS, M. P., GEYER, M. A., LOHR, J. B., KUCZENSKI, R. & NICULESCU, A. B. 2004. Candidate genes, pathways and mechanisms for bipolar (manic-depressive) and related disorders: an expanded convergent functional genomics approach. *Mol Psychiatry*, 9, 1007-29.
- OISHI, K., FUKUI, H. & ISHIDA, N. 2000. Rhythmic expression of BMAL1 mRNA is altered in Clock mutant mice: differential regulation in the suprachiasmatic nucleus and peripheral tissues. *Biochem Biophys Res Commun*, 268, 164-71.
- OISHI, K., MIYAZAKI, K., KADOTA, K., KIKUNO, R., NAGASE, T., ATSUMI, G., OHKURA, N., AZAMA, T., MESAHI, M., YUKIMASA, S., KOBAYASHI, H., IITAKA, C., UMEHARA, T., HORIKOSHI, M., KUDO, T., SHIMIZU, Y., YANO, M., MONDEN, M., MACHIDA, K., MATSUDA, J., HORIE, S., TODO, T. & ISHIDA, N. 2003. Genome-wide expression analysis of mouse liver reveals CLOCK-regulated circadian output genes. *J Biol Chem*, 278, 41519-27.

- OISHI, K., SAKAMOTO, K., OKADA, T., NAGASE, T. & ISHIDA, N. 1998. Humoral signals mediate the circadian expression of rat period homologue (rPer2) mRNA in peripheral tissues. *Neurosci Lett*, 256, 117-9.
- OLIE, J. P. & KASPER, S. 2007. Efficacy of agomelatine, a MT1/MT2 receptor agonist with 5-HT_{2C} antagonistic properties, in major depressive disorder. *Int J Neuropsychopharmacol*, 10, 661-73.
- ORELAND, L. 2004. Platelet monoamine oxidase, personality and alcoholism: the rise, fall and resurrection. *Neurotoxicology*, 25, 79-89.
- OSTER, H., BAERISWYL, S., VAN DER HORST, G. T. & ALBRECHT, U. 2003. Loss of circadian rhythmicity in aging mPer1^{-/-}-mCry2^{-/-} mutant mice. *Genes Dev*, 17, 1366-79.
- OTTE, C., JAHN, H., YASSOURIDIS, A., ARLT, J., STOBER, N., MAASS, P., WIEDEMANN, K. & KELLNER, M. 2003. The mineralocorticoid receptor agonist, fludrocortisone, inhibits pituitary-adrenal activity in humans after pre-treatment with metyrapone. *Life Sci*, 73, 1835-45.
- PACE-SCHOTT, E. F. & HOBSON, J. A. 2002. The neurobiology of sleep: genetics, cellular physiology and subcortical networks. *Nat Rev Neurosci*, 3, 591-605.
- PAGANI, L., SEMENOVA, E. A., MORIGGI, E., REVELL, V. L., HACK, L. M., LOCKLEY, S. W., ARENDT, J., SKENE, D. J., MEIER, F., IZAKOVIC, J., WIRZ-JUSTICE, A., CAJOCHEN, C., SERGEEVA, O. J., CHERESIZ, S. V., DANILENKO, K. V., ECKERT, A. & BROWN, S. A. 2010. The physiological period length of the human circadian clock in vivo is directly proportional to period in human fibroblasts. *PLoS One*, 5, e13376.
- PAIK, J. W., LEE, H. J., KANG, S. G., LIM, S. W., LEE, M. S. & KIM, L. 2007. CLOCK gene 3111C/T polymorphism is not associated with seasonal variations in mood and behavior in Korean college students. *Psychiatry Clin Neurosci*, 61, 124-6.
- PAINÉ, S. J., GANDER, P. H. & TRAVIER, N. 2006. The epidemiology of morningness/eveningness: influence of age, gender, ethnicity, and socioeconomic factors in adults (30-49 years). *J Biol Rhythms*, 21, 68-76.
- PALFREY, J. S., LEVINE, M. D., WALKER, D. K. & SULLIVAN, M. 1985. The emergence of attention deficits in early childhood: a prospective study. *J Dev Behav Pediatr*, 6, 339-48.

- PAN, X., TERADA, T., IRIE, M., SAITO, H. & INUI, K. 2002. Diurnal rhythm of H⁺-peptide cotransporter in rat small intestine. *Am J Physiol Gastrointest Liver Physiol*, 283, G57-64.
- PANDI-PERUMAL, S. R., ZISAPEL, N., SRINIVASAN, V. & CARDINALI, D. P. 2005. Melatonin and sleep in aging population. *Exp Gerontol*, 40, 911-25.
- PARRAN, T. V., JR. & JASINSKI, D. R. 1991. Intravenous methylphenidate abuse. Prototype for prescription drug abuse. *Arch Intern Med*, 151, 781-3.
- PARRY, B. L. & NEWTON, R. P. 2001. Chronobiological basis of female-specific mood disorders. *Neuropsychopharmacology*, 25, S102-8.
- PARTONEN, T. 1998. Extrapineal melatonin and exogenous serotonin in seasonal affective disorder. *Med Hypotheses*, 51, 441-2.
- PARTONEN, T., TREUTLEIN, J., ALPMAN, A., FRANK, J., JOHANSSON, C., DEPNER, M., ARON, L., RIETSCHER, M., WELLEK, S., SORONEN, P., PAUNIO, T., KOCH, A., CHEN, P., LATHROP, M., ADOLFSSON, R., PERSSON, M. L., KASPER, S., SCHALLING, M., PELTONEN, L. & SCHUMANN, G. 2007. Three circadian clock genes *Per2*, *Arntl*, and *Npas2* contribute to winter depression. *Ann Med*, 39, 229-38.
- PATRICK, K. S., STRAUGHN, A. B., PERKINS, J. S. & GONZALEZ, M. A. 2009. Evolution of stimulants to treat ADHD: transdermal methylphenidate. *Hum Psychopharmacol*, 24, 1-17.
- PAULSON, P. E. & ROBINSON, T. E. 1994. Relationship between circadian changes in spontaneous motor activity and dorsal versus ventral striatal dopamine neurotransmission assessed with on-line microdialysis. *Behav Neurosci*, 108, 624-35.
- PAULSON, P. E. & ROBINSON, T. E. 1996. Regional differences in the effects of amphetamine withdrawal on dopamine dynamics in the striatum. Analysis of circadian patterns using automated on-line microdialysis. *Neuropsychopharmacology*, 14, 325-37.
- PAXINOS, G. & FRANKLIN, K.J. 2004. The mouse brain in stereotaxic coordinates. Elsevier Academic Press. USA.
- PEIGNEUX, P., LAUREYS, S., FUCHS, S., COLLETTE, F., PERRIN, F., REGGERS, J., PHILLIPS, C., DEGUELDRE, C., DEL FIORE, G., AERTS, J., LUXEN, A. & MAQUET, P. 2004. Are spatial memories strengthened in the human hippocampus during slow wave sleep? *Neuron*, 44, 535-45.

- PENG, Z. W., CHEN, X. G. & WEI, Z. 2007. Cryptochrome1 maybe a candidate gene of schizophrenia. *Med Hypotheses*, 69, 849-51.
- PEREZ-ALBUERNE, E. D., SCHATTEMAN, G., SANDERS, L. K. & NATHANS, D. 1993. Transcriptional regulatory elements downstream of the JunB gene. *Proc Natl Acad Sci U S A*, 90, 11960-4.
- PERLMAN, C. A., JOHNSON, S. L. & MELLMAN, T. A. 2006. The prospective impact of sleep duration on depression and mania. *Bipolar Disord*, 8, 271-4.
- PETERS, M. L., GODAERT, G. L., BALLIEUX, R. E., VAN VLIET, M., WILLEMSSEN, J. J., SWEEP, F. C. & HEIJNEN, C. J. 1998. Cardiovascular and endocrine responses to experimental stress: effects of mental effort and controllability. *Psychoneuroendocrinology*, 23, 1-17.
- PETERS, R. V., ZOELLER, R. T., HENNESSEY, A. C., STOPA, E. G., ANDERSON, G. & ALBERS, H. E. 1994. The control of circadian rhythms and the levels of vasoactive intestinal peptide mRNA in the suprachiasmatic nucleus are altered in spontaneously hypertensive rats. *Brain Res*, 639, 217-27.
- PETRIE, K., DAWSON, A. G., THOMPSON, L. & BROOK, R. 1993. A double-blind trial of melatonin as a treatment for jet lag in international cabin crew. *Biol Psychiatry*, 33, 526-30.
- PFOHL, B., SHERMAN, B., SCHLECHTE, J. & STONE, R. 1985. Pituitary-adrenal axis rhythm disturbances in psychiatric depression. *Arch Gen Psychiatry*, 42, 897-903.
- PHILIPSEN, A., FEIGE, B., HESSLINGER, B., EBERT, D., CARL, C., HORNYAK, M., LIEB, K., VODERHOLZER, U. & RIEMANN, D. 2005. Sleep in adults with attention-deficit/hyperactivity disorder: a controlled polysomnographic study including spectral analysis of the sleep EEG. *Sleep*, 28, 877-84.
- PICCHIETTI, D. L., ENGLAND, S. J., WALTERS, A. S., WILLIS, K. & VERRICO, T. 1998. Periodic limb movement disorder and restless legs syndrome in children with attention-deficit hyperactivity disorder. *J Child Neurol*, 13, 588-94.
- PICCHIETTI, D. L., UNDERWOOD, D. J., FARRIS, W. A., WALTERS, A. S., SHAH, M. M., DAHL, R. E., TRUBNICK, L. J., BERTOCCI, M. A., WAGNER, M. & HENING, W. A. 1999. Further studies on periodic limb

- movement disorder and restless legs syndrome in children with attention-deficit hyperactivity disorder. *Mov Disord*, 14, 1000-7.
- PICKARD, G. E. 1985. Bifurcating axons of retinal ganglion cells terminate in the hypothalamic suprachiasmatic nucleus and the intergeniculate leaflet of the thalamus. *Neurosci Lett*, 55, 211-7.
- PIERCE, L. X., NOCHE, R. R., PONOMAREVA, O., CHANG, C. & LIANG, J. O. 2008. Novel functions for Period 3 and Exo-rhodopsin in rhythmic transcription and melatonin biosynthesis within the zebrafish pineal organ. *Brain Res*, 1223, 11-24.
- PIGGINS, H. D. & LOUDON, A. 2005. Circadian biology: clocks within clocks. *Curr Biol*, 15, R455-7.
- PIROVANO, A., LORENZI, C., SERRETTI, A., PLOIA, C., LANDONI, S., CATALANO, M. & SMERALDI, E. 2005. Two new rare variants in the circadian "clock" gene may influence sleep pattern. *Genet Med*, 7, 455-7.
- PITROSKY, B., KIRSCH, R., MALAN, A., MOCAER, E. & PEVET, P. 1999. Organization of rat circadian rhythms during daily infusion of melatonin or S20098, a melatonin agonist. *Am J Physiol*, 277, R812-28.
- PITTENDRIGH, C. S., KYNER, W. T. & TAKAMURA, T. 1991. The amplitude of circadian oscillations: temperature dependence, latitudinal clines, and the photoperiodic time measurement. *J Biol Rhythms*, 6, 299-313.
- PREITNER, N., DAMIOLA, F., LOPEZ-MOLINA, L., ZAKANY, J., DUBOULE, D., ALBRECHT, U. & SCHIBLER, U. 2002. The orphan nuclear receptor REV-ERB α controls circadian transcription within the positive limb of the mammalian circadian oscillator. *Cell*, 110, 251-60.
- PROSSER, R. A., DEAN, R. R., EDGAR, D. M., HELLER, H. C. & MILLER, J. D. 1993. Serotonin and the mammalian circadian system: I. In vitro phase shifts by serotonergic agonists and antagonists. *J Biol Rhythms*, 8, 1-16.
- PRUESSNER, J. C., KIRSCHBAUM, C., MEINLSCHMID, G. & HELLHAMMER, D. H. 2003. Two formulas for computation of the area under the curve represent measures of total hormone concentration versus time-dependent change. *Psychoneuroendocrinology*, 28, 916-31.
- QUAY, H. C. 1997. Inhibition and attention deficit hyperactivity disorder. *J Abnorm Child Psychol*, 25, 7-13.

- RALPH, M. R., FOSTER, R. G., DAVIS, F. C. & MENAKER, M. 1990. Transplanted suprachiasmatic nucleus determines circadian period. *Science*, 247, 975-8.
- RALPH, M. R. & MENAKER, M. 1988. A mutation of the circadian system in golden hamsters. *Science*, 241, 1225-7.
- RAMOS PLATON, M. J., VELA BUENO, A., ESPINAR SIERRA, J. & KALES, S. 1990. Hypnopolygraphic alterations in Attention Deficit Disorder (ADD) children. *Int J Neurosci*, 53, 87-101.
- RANDAZZO, W. T., DOCKRAY, S. & SUSMAN, E. J. 2008. The stress response in adolescents with inattentive type ADHD symptoms. *Child Psychiatry Hum Dev*, 39, 27-38.
- RANDLER, C. & SCHAAL, S. 2010. Morningness-eveningness, habitual sleep-wake variables and cortisol level. *Biol Psychol*, 85, 14-8.
- RAUSCH, J. L., JOHNSON, M. E., CORLEY, K. M., HOBBY, H. M., SHENDARKAR, N., FEI, Y., GANAPATHY, V. & LEIBACH, F. H. 2003. Depressed patients have higher body temperature: 5-HT transporter long promoter region effects. *Neuropsychobiology*, 47, 120-7.
- REA, M. A., GLASS, J. D. & COLWELL, C. S. 1994. Serotonin modulates photic responses in the hamster suprachiasmatic nuclei. *J Neurosci*, 14, 3635-42.
- RECIO, J., PEVET, P. & MASSON-PEVET, M. 1996. Serotonergic modulation of photically induced increase in melatonin receptor density and Fos immunoreactivity in the suprachiasmatic nuclei of the rat. *J Neuroendocrinol*, 8, 839-45.
- REDDY, A. B., KARP, N. A., MAYWOOD, E. S., SAGE, E. A., DEERY, M., O'NEILL, J. S., WONG, G. K., CHESHAM, J., ODELL, M., LILLEY, K. S., KYRIACOU, C. P. & HASTINGS, M. H. 2006. Circadian orchestration of the hepatic proteome. *Curr Biol*, 16, 1107-15.
- REDMAN, J. R. & FRANCIS, A. J. 1998. Entrainment of rat circadian rhythms by the melatonin agonist S-20098 requires intact suprachiasmatic nuclei but not the pineal. *J Biol Rhythms*, 13, 39-51.
- REDMAN, J. R., GUARDIOLA-LEMAITRE, B., BROWN, M., DELAGRANGE, P. & ARMSTRONG, S. M. 1995. Dose dependent effects of S-20098, a melatonin agonist, on direction of re-entrainment of rat circadian activity rhythms. *Psychopharmacology (Berl)*, 118, 385-90.

- REICK, M., GARCIA, J. A., DUDLEY, C. & MCKNIGHT, S. L. 2001. NPAS2: an analog of clock operative in the mammalian forebrain. *Science*, 293, 506-9.
- REPPERT, S. M. & WEAVER, D. R. 2001. Molecular analysis of mammalian circadian rhythms. *Annu Rev Physiol*, 63, 647-76.
- REPPERT, S. M. & WEAVER, D. R. 2002. Coordination of circadian timing in mammals. *Nature*, 418, 935-41.
- REPPERT, S. M., WEAVER, D. R. & GODSON, C. 1996. Melatonin receptors step into the light: cloning and classification of subtypes. *Trends Pharmacol Sci*, 17, 100-2.
- REPPERT, S. M., WEAVER, D. R., RIVKEES, S. A. & STOPA, E. G. 1988. Putative melatonin receptors in a human biological clock. *Science*, 242, 78-81.
- RETZ, W., ROSLER, M., SUPPRIAN, T., RETZ-JUNGINGER, P. & THOME, J. 2003. Dopamine D3 receptor gene polymorphism and violent behavior: relation to impulsiveness and ADHD-related psychopathology. *J Neural Transm*, 110, 561-72.
- RETZ, W., THOME, J., BLOCHER, D., BAADER, M. & ROSLER, M. 2002. Association of attention deficit hyperactivity disorder-related psychopathology and personality traits with the serotonin transporter promoter region polymorphism. *Neurosci Lett*, 319, 133-6.
- RICHARDSON, G. A. & DAY, N. L. 1994. Detrimental effects of prenatal cocaine exposure: illusion or reality? *J Am Acad Child Adolesc Psychiatry*, 33, 28-34.
- RIEMANN, D., BERGER, M. & VODERHOLZER, U. 2001. Sleep and depression--results from psychobiological studies: an overview. *Biol Psychol*, 57, 67-103.
- RIGGS, P. D., LEON, S. L., MIKULICH, S. K. & POTTLE, L. C. 1998. An open trial of bupropion for ADHD in adolescents with substance use disorders and conduct disorder. *J Am Acad Child Adolesc Psychiatry*, 37, 1271-8.
- RIPPERGER, J. A., SHEARMAN, L. P., REPPERT, S. M. & SCHIBLER, U. 2000. CLOCK, an essential pacemaker component, controls expression of the circadian transcription factor DBP. *Genes Dev*, 14, 679-89.
- ROBBINS, T. W., JAMES, M., OWEN, A. M., SAHAKIAN, B. J., LAWRENCE, A. D., MCINNES, L. & RABBITT, P. M. 1998. A study of performance on tests from the CANTAB battery sensitive to frontal lobe dysfunction in a large sample of normal volunteers: implications for theories of executive

- functioning and cognitive aging. Cambridge Neuropsychological Test Automated Battery. *J Int Neuropsychol Soc*, 4, 474-90.
- ROBILLIARD, D. L., ARCHER, S. N., ARENDT, J., LOCKLEY, S. W., HACK, L. M., ENGLISH, J., LEGER, D., SMITS, M. G., WILLIAMS, A., SKENE, D. J. & VON SCHANTZ, M. 2002. The 3111 Clock gene polymorphism is not associated with sleep and circadian rhythmicity in phenotypically characterized human subjects. *J Sleep Res*, 11, 305-12.
- ROSENWASSER, A. M. 1993. Circadian drinking rhythms in SHR and WKY rats: effects of increasing light intensity. *Physiol Behav*, 53, 1035-41.
- ROSENWASSER, A. M. 1996. Clonidine shortens circadian period in both constant light and constant darkness. *Physiol Behav*, 60, 373-9.
- ROSENWASSER, A. M. 2010. Circadian clock genes: non-circadian roles in sleep, addiction, and psychiatric disorders? *Neurosci Biobehav Rev*, 34, 1249-55.
- ROSENWASSER, A. M. & PLANTE, L. 1993. Circadian activity rhythms in SHR and WKY rats: strain differences and effects of clonidine. *Physiol Behav*, 53, 23-9.
- ROSLER, M., RETZ, W., RETZ-JUNGINGER, P., HENGESCH, G., SCHNEIDER, M., SUPPRIAN, T., SCHWITZGEBEL, P., PINHARD, K., DOVI-AKUE, N., WENDER, P. & THOME, J. 2004. Prevalence of attention deficit/hyperactivity disorder (ADHD) and comorbid disorders in young male prison inmates. *Eur Arch Psychiatry Clin Neurosci*, 254, 365-71.
- ROSS, J. 1996. Control of messenger RNA stability in higher eukaryotes. *Trends Genet*, 12, 171-5.
- ROTHSCHILD, A. J., SCHATZBERG, A. F., ROSENBAUM, A. H., STAHL, J. B. & COLE, J. O. 1982. The dexamethasone suppression test as a discriminator among subtypes of psychotic patients. *Br J Psychiatry*, 141, 471-4.
- ROWLAND, A. S., LESESNE, C. A. & ABRAMOWITZ, A. J. 2002. The epidemiology of attention-deficit/hyperactivity disorder (ADHD): a public health view. *Ment Retard Dev Disabil Res Rev*, 8, 162-70.
- ROYBAL, K., THEOBOLD, D., GRAHAM, A., DINIERI, J. A., RUSSO, S. J., KRISHNAN, V., CHAKRAVARTY, S., PEEVEY, J., OEHRLEIN, N., BIRNBAUM, S., VITATERNA, M. H., ORSULAK, P., TAKAHASHI, J. S., NESTLER, E. J., CARLEZON, W. A., JR. & MCCLUNG, C. A. 2007.

- Mania-like behavior induced by disruption of CLOCK. *Proc Natl Acad Sci U S A*, 104, 6406-11.
- RUBIN, R. T., HEIST, E. K., MCGEOY, S. S., HANADA, K. & LESSER, I. M. 1992. Neuroendocrine aspects of primary endogenous depression. XI. Serum melatonin measures in patients and matched control subjects. *Arch Gen Psychiatry*, 49, 558-67.
- RUBY, N. F., HWANG, C. E., WESSELLS, C., FERNANDEZ, F., ZHANG, P., SAPOLSKY, R. & HELLER, H. C. 2008. Hippocampal-dependent learning requires a functional circadian system. *Proc Natl Acad Sci U S A*, 105, 15593-8.
- RUETER, L. E. & JACOBS, B. L. 1996. Changes in forebrain serotonin at the light-dark transition: correlation with behaviour. *Neuroreport*, 7, 1107-11.
- RUGINO, T. A. & COPLEY, T. C. 2001. Effects of modafinil in children with attention-deficit/hyperactivity disorder: an open-label study. *J Am Acad Child Adolesc Psychiatry*, 40, 230-5.
- RUSSELL, V. A. 2000. The nucleus accumbens motor-limbic interface of the spontaneously hypertensive rat as studied in vitro by the superfusion slice technique. *Neurosci Biobehav Rev*, 24, 133-6.
- RUSSELL, V. A. 2002. Hypodopaminergic and hypernoradrenergic activity in prefrontal cortex slices of an animal model for attention-deficit hyperactivity disorder--the spontaneously hypertensive rat. *Behav Brain Res*, 130, 191-6.
- RUSSELL, V. A. 2003. Dopamine hypofunction possibly results from a defect in glutamate-stimulated release of dopamine in the nucleus accumbens shell of a rat model for attention deficit hyperactivity disorder--the spontaneously hypertensive rat. *Neurosci Biobehav Rev*, 27, 671-82.
- RUSSELL, V. A. 2007. Reprint of "Neurobiology of animal models of attention-deficit hyperactivity disorder". *J Neurosci Methods*, 166, I-XIV.
- RYAN, M. C., SHARIFI, N., CONDREN, R. & THAKORE, J. H. 2004. Evidence of basal pituitary-adrenal overactivity in first episode, drug naive patients with schizophrenia. *Psychoneuroendocrinology*, 29, 1065-70.
- RYBAK, Y. E., MCNEELY, H. E., MACKENZIE, B. E., JAIN, U. R. & LEVITAN, R. D. 2006. An open trial of light therapy in adult attention-deficit/hyperactivity disorder. *J Clin Psychiatry*, 67, 1527-35.

- RYBAK, Y. E., MCNEELY, H. E., MACKENZIE, B. E., JAIN, U. R. & LEVITAN, R. D. 2007. Seasonality and circadian preference in adult attention-deficit/hyperactivity disorder: clinical and neuropsychological correlates. *Compr Psychiatry*, 48, 562-71.
- SACK, R. L., LEWY, A. J., BLOOD, M. L., STEVENSON, J. & KEITH, L. D. 1991. Melatonin administration to blind people: phase advances and entrainment. *J Biol Rhythms*, 6, 249-61.
- SADEH, A., HAURI, P. J., KRIPKE, D. F. & LAVIE, P. 1995. The role of actigraphy in the evaluation of sleep disorders. *Sleep*, 18, 288-302.
- SAFREN, S. A., OTTO, M. W., SPRICH, S., WINETT, C. L., WILENS, T. E. & BIEDERMAN, J. 2005. Cognitive-behavioral therapy for ADHD in medication-treated adults with continued symptoms. *Behav Res Ther*, 43, 831-42.
- SAGVOLDEN, T. 2000. Behavioral validation of the spontaneously hypertensive rat (SHR) as an animal model of attention-deficit/hyperactivity disorder (AD/HD). *Neurosci Biobehav Rev*, 24, 31-9.
- SAGVOLDEN, T., JOHANSEN, E. B., AASE, H. & RUSSELL, V. A. 2005a. A dynamic developmental theory of attention-deficit/hyperactivity disorder (ADHD) predominantly hyperactive/impulsive and combined subtypes. *Behav Brain Sci*, 28, 397-419; discussion 419-68.
- SAGVOLDEN, T., RUSSELL, V. A., AASE, H., JOHANSEN, E. B. & FARSHBAF, M. 2005b. Rodent models of attention-deficit/hyperactivity disorder. *Biol Psychiatry*, 57, 1239-47.
- SAIGAL, S., PINELLI, J., HOULT, L., KIM, M. M. & BOYLE, M. 2003. Psychopathology and social competencies of adolescents who were extremely low birth weight. *Pediatrics*, 111, 969-75.
- SAITO, Y., NOTHACKER, H. P., WANG, Z., LIN, S. H., LESLIE, F. & CIVELLI, O. 1999. Molecular characterization of the melanin-concentrating-hormone receptor. *Nature*, 400, 265-9.
- SANDYK, R. & KANOFSKY, J. D. 1992. Cocaine addiction: relationship to seasonal affective disorder. *Int J Neurosci*, 64, 195-201.
- SANGAL, R. B., OWENS, J., ALLEN, A. J., SUTTON, V., SCHUH, K. & KELSEY, D. 2006. Effects of atomoxetine and methylphenidate on sleep in children with ADHD. *Sleep*, 29, 1573-85.

- SAPER, C. B., LU, J., CHOU, T. C. & GOOLEY, J. 2005. The hypothalamic integrator for circadian rhythms. *Trends Neurosci*, 28, 152-7.
- SATEL, S. L. & GAWIN, F. H. 1989. Seasonal cocaine abuse. *Am J Psychiatry*, 146, 534-5.
- SCAHILL, L. & SCHWAB-STONE, M. 2000. Epidemiology of ADHD in school-age children. *Child Adolesc Psychiatr Clin N Am*, 9, 541-55, vii.
- SCARBROUGH, K. & TUREK, F. W. 1996. Quantitative differences in the circadian rhythm of locomotor activity and vasopressin and vasoactive intestinal peptide gene expression in the suprachiasmatic nucleus of tau mutant compared to wildtype hamsters. *Brain Res*, 736, 251-9.
- SCHAAP, J., ALBUS, H., VANDERLEEST, H. T., EILERS, P. H., DETARI, L. & MEIJER, J. H. 2003. Heterogeneity of rhythmic suprachiasmatic nucleus neurons: Implications for circadian waveform and photoperiodic encoding. *Proc Natl Acad Sci U S A*, 100, 15994-9.
- SCHAAP, J., BOS, N. P., DE JEU, M. T., GEURTSSEN, A. M., MEIJER, J. H. & PENNARTZ, C. M. 1999. Neurons of the rat suprachiasmatic nucleus show a circadian rhythm in membrane properties that is lost during prolonged whole-cell recording. *Brain Res*, 815, 154-66.
- SCHEER, F. A. & BUIJS, R. M. 1999. Light affects morning salivary cortisol in humans. *J Clin Endocrinol Metab*, 84, 3395-8.
- SCHMIDT, C., COLLETTE, F., LECLERCQ, Y., STERPENICH, V., VANDEWALLE, G., BERTHOMIER, P., BERTHOMIER, C., PHILLIPS, C., TINGUELY, G., DARSAUD, A., GAIS, S., SCHABUS, M., DESSEILLES, M., DANG-VU, T. T., SALMON, E., BALTEAU, E., DEGUELDRE, C., LUXEN, A., MAQUET, P., CAJOCHEN, C. & PEIGNEUX, P. 2009. Homeostatic sleep pressure and responses to sustained attention in the suprachiasmatic area. *Science*, 324, 516-9.
- SCHMITTGEN, T. D. & ZAKRAJSEK, B. A. 2000. Effect of experimental treatment on housekeeping gene expression: validation by real-time, quantitative RT-PCR. *J Biochem Biophys Methods*, 46, 69-81.
- SCHROETER, S., APPARSUNDARAM, S., WILEY, R. G., MINER, L. H., SESACK, S. R. & BLAKELY, R. D. 2000. Immunolocalization of the cocaine- and antidepressant-sensitive l-norepinephrine transporter. *J Comp Neurol*, 420, 211-32.

- SCHUHLER, S., SABOUREAU, M., PITROSKY, B. & PEVET, P. 1998. In Syrian hamsters, 5-HT fibres within the suprachiasmatic nuclei are necessary for the expression of 8-OH-DPAT induced phase-advance of locomotor activity rhythm. *Neurosci Lett*, 256, 33-6.
- SCHWARTZ, W. J. 1991. Further evaluation of the tetrodotoxin-resistant circadian pacemaker in the suprachiasmatic nuclei. *J Biol Rhythms*, 6, 149-58.
- SCHWARTZ, W. J., GROSS, R. A. & MORTON, M. T. 1987. The suprachiasmatic nuclei contain a tetrodotoxin-resistant circadian pacemaker. *Proc Natl Acad Sci USA*, 84, 1694-8.
- SCHWARTZ, W. J. & ZIMMERMAN, P. 1990. Circadian timekeeping in BALB/c and C57BL/6 inbred mouse strains. *J Neurosci*, 10, 3685-94.
- SEIDLER, F. J., LEVIN, E. D., LAPPI, S. E. & SLOTKIN, T. A. 1992. Fetal nicotine exposure ablates the ability of postnatal nicotine challenge to release norepinephrine from rat brain regions. *Brain Res Dev Brain Res*, 69, 288-91.
- SELEK, S., SAVAS, H. A., GERGERLIOGLU, H. S., BULUT, M. & YILMAZ, H. R. 2008. Oxidative imbalance in adult attention deficit/hyperactivity disorder. *Biol Psychol*, 79, 256-9.
- SELIM, M., GLASS, J. D., HAUSER, U. E. & REA, M. A. 1993. Serotonergic inhibition of light-induced fos protein expression and extracellular glutamate in the suprachiasmatic nuclei. *Brain Res*, 621, 181-8.
- SERRETTI, A., BENEDETTI, F., MANDELLI, L., LORENZI, C., PIROVANO, A., COLOMBO, C. & SMERALDI, E. 2003. Genetic dissection of psychopathological symptoms: insomnia in mood disorders and CLOCK gene polymorphism. *Am J Med Genet B Neuropsychiatr Genet*, 121B, 35-8.
- SERRETTI, A., CUSIN, C., BENEDETTI, F., MANDELLI, L., PIROVANO, A., ZANARDI, R., COLOMBO, C. & SMERALDI, E. 2005. Insomnia improvement during antidepressant treatment and CLOCK gene polymorphism. *Am J Med Genet B Neuropsychiatr Genet*, 137B, 36-9.
- SESACK, S. R., HAWRYLAK, V. A., MATUS, C., GUIDO, M. A. & LEVEY, A. I. 1998. Dopamine axon varicosities in the prelimbic division of the rat prefrontal cortex exhibit sparse immunoreactivity for the dopamine transporter. *J Neurosci*, 18, 2697-708.
- SHALEV, U., YAP, J. & SHAHAM, Y. 2001. Leptin attenuates acute food deprivation-induced relapse to heroin seeking. *J Neurosci*, 21, RC129.

- SHEARMAN, L. P., JIN, X., LEE, C., REPPERT, S. M. & WEAVER, D. R. 2000a. Targeted disruption of the mPer3 gene: subtle effects on circadian clock function. *Mol Cell Biol*, 20, 6269-75.
- SHEARMAN, L. P., SRIRAM, S., WEAVER, D. R., MAYWOOD, E. S., CHAVES, I., ZHENG, B., KUME, K., LEE, C. C., VAN DER HORST, G. T., HASTINGS, M. H. & REPPERT, S. M. 2000b. Interacting molecular loops in the mammalian circadian clock. *Science*, 288, 1013-9.
- SHEN, H., WATANABE, M., TOMASIEWICZ, H., RUTISHAUSER, U., MAGNUSON, T. & GLASS, J. D. 1997. Role of neural cell adhesion molecule and polysialic acid in mouse circadian clock function. *J Neurosci*, 17, 5221-9.
- SHI, J., WITTKE-THOMPSON, J. K., BADNER, J. A., HATTORI, E., POTASH, J. B., WILLOUR, V. L., MCMAHON, F. J., GERSHON, E. S. & LIU, C. 2008. Clock genes may influence bipolar disorder susceptibility and dysfunctional circadian rhythm. *Am J Med Genet B Neuropsychiatr Genet*, 147B, 1047-55.
- SHI, S., HIDA, A., MCGUINNESS, O. P., WASSERMAN, D. H., YAMAZAKI, S. & JOHNSON, C. H. 2010. Circadian clock gene Bmal1 is not essential; functional replacement with its paralog, Bmal2. *Curr Biol*, 20, 316-21.
- SHIBATA, S., OOMURA, Y., KITA, H. & HATTORI, K. 1982. Circadian rhythmic changes of neuronal activity in the suprachiasmatic nucleus of the rat hypothalamic slice. *Brain Res*, 247, 154-8.
- SHINOHARA, M. L., LOROS, J. J. & DUNLAP, J. C. 1998. Glyceraldehyde-3-phosphate dehydrogenase is regulated on a daily basis by the circadian clock. *J Biol Chem*, 273, 446-52.
- SHIRAYAMA, M., SHIRAYAMA, Y., IIDA, H., KATO, M., KAJIMURA, N., WATANABE, T., SEKIMOTO, M., SHIRAKAWA, S., OKAWA, M. & TAKAHASHI, K. 2003. The psychological aspects of patients with delayed sleep phase syndrome (DSPS). *Sleep Med*, 4, 427-33.
- SHOBLock, J. R., MAISONNEUVE, I. M. & GLICK, S. D. 2003a. Differences between d-methamphetamine and d-amphetamine in rats: working memory, tolerance, and extinction. *Psychopharmacology (Berl)*, 170, 150-6.
- SHOBLock, J. R., MAISONNEUVE, I. M. & GLICK, S. D. 2004. Differential interactions of desipramine with amphetamine and methamphetamine:

evidence that amphetamine releases dopamine from noradrenergic neurons in the medial prefrontal cortex. *Neurochem Res*, 29, 1437-42.

- SHOBLock, J. R., SULLIVAN, E. B., MAISONNEUVE, I. M. & GLICK, S. D. 2003b. Neurochemical and behavioral differences between d-methamphetamine and d-amphetamine in rats. *Psychopharmacology (Berl)*, 165, 359-69.
- SIEGEL, J. M. 2001. The REM sleep-memory consolidation hypothesis. *Science*, 294, 1058-63.
- SIMON, N., VIDAL, J., MOUCHET, J. & BRUGUEROLLE, B. 2002. Lack of daily rhythms major modifications despite continuous infusion of melatonin in the rat. *J Vet Pharmacol Ther*, 25, 285-8.
- SIMONNEAUX, V., POIREL, V. J., GARIDOU, M. L., NGUYEN, D., DIAZ-RODRIGUEZ, E. & PEVET, P. 2004. Daily rhythm and regulation of clock gene expression in the rat pineal gland. *Brain Res Mol Brain Res*, 120, 164-72.
- SIROVER, M. A. 1999. New insights into an old protein: the functional diversity of mammalian glyceraldehyde-3-phosphate dehydrogenase. *Biochim Biophys Acta*, 1432, 159-84.
- SIT, D., WISNER, K. L., HANUSA, B. H., STULL, S. & TERMAN, M. 2007. Light therapy for bipolar disorder: a case series in women. *Bipolar Disord*, 9, 918-27.
- SLOTKIN, T. A. 1998. Fetal nicotine or cocaine exposure: which one is worse? *J Pharmacol Exp Ther*, 285, 931-45.
- SLOTKIN, T. A. & BARTOLOME, J. 1986. Role of ornithine decarboxylase and the polyamines in nervous system development: a review. *Brain Res Bull*, 17, 307-20.
- SMALE, L., MICHELS, K. M., MOORE, R. Y. & MORIN, L. P. 1990. Destruction of the hamster serotonergic system by 5,7-DHT: effects on circadian rhythm phase, entrainment and response to triazolam. *Brain Res*, 515, 9-19.
- SMALLEY, S. L., MCGOUGH, J. J., DEL'HOMME, M., NEWDELMAN, J., GORDON, E., KIM, T., LIU, A. & MCCRACKEN, J. T. 2000. Familial clustering of symptoms and disruptive behaviors in multiplex families with attention-deficit/hyperactivity disorder. *J Am Acad Child Adolesc Psychiatry*, 39, 1135-43.

- SMITH, A. D., OLSON, R. J. & JUSTICE, J. B., JR. 1992. Quantitative microdialysis of dopamine in the striatum: effect of circadian variation. *J Neurosci Methods*, 44, 33-41.
- SNOEK, H., VAN GOOZEN, S. H., MATTHYS, W., BUITELAAR, J. K. & VAN ENGELAND, H. 2004. Stress responsivity in children with externalizing behavior disorders. *Dev Psychopathol*, 16, 389-406.
- SOBANSKI, E., SCHREDL, M., KETTLER, N. & ALM, B. 2008. Sleep in adults with attention deficit hyperactivity disorder (ADHD) before and during treatment with methylphenidate: a controlled polysomnographic study. *Sleep*, 31, 375-81.
- SOFUOGLU, M., POLING, J., HILL, K. & KOSTEN, T. 2009. Atomoxetine attenuates dextroamphetamine effects in humans. *Am J Drug Alcohol Abuse*, 35, 412-6.
- SOLANAS, M., MORAL, R. & ESCRICH, E. 2001. Unsuitability of using ribosomal RNA as loading control for Northern blot analyses related to the imbalance between messenger and ribosomal RNA content in rat mammary tumors. *Anal Biochem*, 288, 99-102.
- SOLANTO, M. V. 1998. Neuropsychopharmacological mechanisms of stimulant drug action in attention-deficit hyperactivity disorder: a review and integration. *Behav Brain Res*, 94, 127-52.
- SONDEIJKER, F. E., FERDINAND, R. F., OLDEHINKEL, A. J., VEENSTRA, R., TIEMEIER, H., ORMEL, J. & VERHULST, F. C. 2007. Disruptive behaviors and HPA-axis activity in young adolescent boys and girls from the general population. *J Psychiatr Res*, 41, 570-8.
- SOUCY, J. P., MRINI, A., LAFAILLE, F., DOUCET, G. & DESCARRIES, L. 1997. Comparative evaluation of [3H]WIN 35428 and [3H]GBR 12935 as markers of dopamine innervation density in brain. *Synapse*, 25, 163-75.
- SOUETRE, E., SALVATI, E., BELUGOU, J. L., PRINGUEY, D., CANDITO, M., KREBS, B., ARDISSON, J. L. & DAR COURT, G. 1989. Circadian rhythms in depression and recovery: evidence for blunted amplitude as the main chronobiological abnormality. *Psychiatry Res*, 28, 263-78.
- SPANAGEL, R., PENDYALA, G., ABARCA, C., ZGHOUL, T., SANCHIS-SEGURA, C., MAGNONE, M. C., LASCORZ, J., DEPNER, M., HOLZBERG, D., SOYKA, M., SCHREIBER, S., MATSUDA, F.,

- LATHROP, M., SCHUMANN, G. & ALBRECHT, U. 2005. The clock gene Per2 influences the glutamatergic system and modulates alcohol consumption. *Nat Med*, 11, 35-42.
- SPANAKIS, E. 1993. Problems related to the interpretation of autoradiographic data on gene expression using common constitutive transcripts as controls. *Nucleic Acids Res*, 21, 3809-19.
- SPENCER, T., BIEDERMAN, J. & WILENS, T. 2000. Pharmacotherapy of attention deficit hyperactivity disorder. *Child Adolesc Psychiatr Clin N Am*, 9, 77-97.
- SRINIVASAN, V., SMITS, M., SPENCE, W., LOWE, A. D., KAYUMOV, L., PANDI-PERUMAL, S. R., PARRY, B. & CARDINALI, D. P. 2006. Melatonin in mood disorders. *World J Biol Psychiatry*, 7, 138-51.
- STEIN, D. J., HOLLANDER, E. & LIEBOWITZ, M. R. 1993. Neurobiology of impulsivity and the impulse control disorders. *J Neuropsychiatry Clin Neurosci*, 5, 9-17.
- STEINER, H., VAN WAES, V. & MARINELLI, M. 2010. Fluoxetine potentiates methylphenidate-induced gene regulation in addiction-related brain regions: concerns for use of cognitive enhancers? *Biol Psychiatry*, 67, 592-4.
- STEPHAN, F. K. & ZUCKER, I. 1972. Circadian rhythms in drinking behavior and locomotor activity of rats are eliminated by hypothalamic lesions. *Proc Natl Acad Sci U S A*, 69, 1583-6.
- STEWART, J. W., QUITKIN, F. M., TERMAN, M. & TERMAN, J. S. 1990. Is seasonal affective disorder a variant of atypical depression? Differential response to light therapy. *Psychiatry Res*, 33, 121-8.
- STORCH, K. F., LIPAN, O., LEYKIN, I., VISWANATHAN, N., DAVIS, F. C., WONG, W. H. & WEITZ, C. J. 2002. Extensive and divergent circadian gene expression in liver and heart. *Nature*, 417, 78-83.
- SUJINO, M., MASUMOTO, K. H., YAMAGUCHI, S., VAN DER HORST, G. T., OKAMURA, H. & INOUE, S. T. 2003. Suprachiasmatic nucleus grafts restore circadian behavioral rhythms of genetically arrhythmic mice. *Curr Biol*, 13, 664-8.
- SUMOVA, A., MAYWOOD, E. S., SELVAGE, D., EBLING, F. J. & HASTINGS, M. H. 1996. Serotonergic antagonists impair arousal-induced phase shifts of the circadian system of the syrian hamster. *Brain Res*, 709, 88-96.

- SUZUKI, K., MINEI, L. J. & JOHNSON, E. E. 1980. Effect of nicotine upon uterine blood flow in the pregnant rhesus monkey. *Am J Obstet Gynecol*, 136, 1009-13.
- TAILLARD, J., PHILIP, P. & BIOULAC, B. 1999. Morningness/eveningness and the need for sleep. *J Sleep Res*, 8, 291-5.
- TAKAHATA, S., OZAKI, T., MIMURA, J., KIKUCHI, Y., SOGAWA, K. & FUJII-KURIYAMA, Y. 2000. Transactivation mechanisms of mouse clock transcription factors, mClock and mArnt3. *Genes Cells*, 5, 739-47.
- TAKAO, T., TACHIKAWA, H., KAWANISHI, Y., MIZUKAMI, K. & ASADA, T. 2007. CLOCK gene T3111C polymorphism is associated with Japanese schizophrenics: a preliminary study. *Eur Neuropsychopharmacol*, 17, 273-6.
- TAKATA, M., BURIOKA, N., OHDO, S., TAKANE, H., TERAZONO, H., MIYATA, M., SAKO, T., SUYAMA, H., FUKUOKA, Y., TOMITA, K. & SHIMIZU, E. 2002. Daily expression of mRNAs for the mammalian Clock genes *Per2* and *clock* in mouse suprachiasmatic nuclei and liver and human peripheral blood mononuclear cells. *Jpn J Pharmacol*, 90, 263-9.
- TAKEKIDA, S., YAN, L., MAYWOOD, E. S., HASTINGS, M. H. & OKAMURA, H. 2000. Differential adrenergic regulation of the circadian expression of the clock genes *Period1* and *Period2* in the rat pineal gland. *Eur J Neurosci*, 12, 4557-61.
- TAMOTSU, S., SCHOMERUS, C., STEHLE, J. H., ROSEBOOM, P. H. & KORF, H. W. 1995. Norepinephrine-induced phosphorylation of the transcription factor CREB in isolated rat pinealocytes: an immunocytochemical study. *Cell Tissue Res*, 282, 219-26.
- TATAROGLU, O., DAVIDSON, A. J., BENVENUTO, L. J. & MENAKER, M. 2006. The methamphetamine-sensitive circadian oscillator (MASCO) in mice. *J Biol Rhythms*, 21, 185-94.
- TAYLOR, F. B. & RUSSO, J. 2000. Efficacy of modafinil compared to dextroamphetamine for the treatment of attention deficit hyperactivity disorder in adults. *J Child Adolesc Psychopharmacol*, 10, 311-20.
- TAYLOR, S., WAKEM, M., DIJKMAN, G., ALSARRAJ, M. & NGUYEN, M. 2010. A practical approach to RT-qPCR-Publishing data that conform to the MIQE guidelines. *Methods*, 50, S1-5.

- TEBOUL, M., BARRAT-PETIT, M. A., LI, X. M., CLAUSTRAT, B., FORMENTO, J. L., DELAUNAY, F., LEVI, F. & MILANO, G. 2005. Atypical patterns of circadian clock gene expression in human peripheral blood mononuclear cells. *J Mol Med*, 83, 693-9.
- TENN, C. C. & NILES, L. P. 1997. The antidopaminergic action of S-20098 is mediated by benzodiazepine/GABA(A) receptors in the striatum. *Brain Res*, 756, 293-6.
- TER HORST, G. J. & LUITEN, P. G. 1986. The projections of the dorsomedial hypothalamic nucleus in the rat. *Brain Res Bull*, 16, 231-48.
- TERMAN, M. 2007. Evolving applications of light therapy. *Sleep Med Rev*, 11, 497-507.
- TERMAN, M., SCHLAGER, D., FAIRHURST, S. & PERLMAN, B. 1989. Dawn and dusk simulation as a therapeutic intervention. *Biol Psychiatry*, 25, 966-70.
- TERMAN, M. & TERMAN, J. S. 2006. Controlled trial of naturalistic dawn simulation and negative air ionization for seasonal affective disorder. *Am J Psychiatry*, 163, 2126-33.
- TERMAN, M., TERMAN, J. S. & ROSS, D. C. 1998. A controlled trial of timed bright light and negative air ionization for treatment of winter depression. *Arch Gen Psychiatry*, 55, 875-82.
- THEODOSIS, D. T., BONHOMME, R., VITIELLO, S., ROUGON, G. & POULAIN, D. A. 1999. Cell surface expression of polysialic acid on NCAM is a prerequisite for activity-dependent morphological neuronal and glial plasticity. *J Neurosci*, 19, 10228-36.
- THOME, J. & JACOBS, K. A. 2004. Attention deficit hyperactivity disorder (ADHD) in a 19th century children's book. *Eur Psychiatry*, 19, 303-6.
- THOME, J., SAKAI, N., SHIN, K., STEFFEN, C., ZHANG, Y. J., IMPEY, S., STORM, D. & DUMAN, R. S. 2000. cAMP response element-mediated gene transcription is upregulated by chronic antidepressant treatment. *J Neurosci*, 20, 4030-6.
- THOMPSON, C., MEZEY, G., CORN, T., FRANNEY, C., ENGLISH, J., ARENDT, J. & CHECKLEY, S. A. 1985. The effect of desipramine upon melatonin and cortisol secretion in depressed and normal subjects. *Br J Psychiatry*, 147, 389-93.

- THOMPSON, R. H., CANTERAS, N. S. & SWANSON, L. W. 1996. Organization of projections from the dorsomedial nucleus of the hypothalamus: a PHA-L study in the rat. *J Comp Neurol*, 376, 143-73.
- THOMPSON, R. H. & SWANSON, L. W. 1998. Organization of inputs to the dorsomedial nucleus of the hypothalamus: a reexamination with Fluorogold and PHAL in the rat. *Brain Res Brain Res Rev*, 27, 89-118.
- THONBERG, H., FREDRIKSSON, J. M., NEDERGAARD, J. & CANNON, B. 2002. A novel pathway for adrenergic stimulation of cAMP-response-element-binding protein (CREB) phosphorylation: mediation via alpha1-adrenoceptors and protein kinase C activation. *Biochem J*, 364, 73-9.
- TJON PIAN GI, C. V., BROEREN, J. P., STARREVELD, J. S. & VERSTEEGH, F. G. 2003. Melatonin for treatment of sleeping disorders in children with attention deficit/hyperactivity disorder: a preliminary open label study. *Eur J Pediatr*, 162, 554-5.
- TOH, K. L., JONES, C. R., HE, Y., EIDE, E. J., HINZ, W. A., VIRSHUP, D. M., PTACEK, L. J. & FU, Y. H. 2001. An hPer2 phosphorylation site mutation in familial advanced sleep phase syndrome. *Science*, 291, 1040-3.
- TOKUNAGA, K., FUKUSHIMA, M., KEMNITZ, J. W. & BRAY, G. A. 1986. Comparison of ventromedial and paraventricular lesions in rats that become obese. *Am J Physiol*, 251, R1221-7.
- TOMINAGA, K., SHIBATA, S., UEKI, S. & WATANABE, S. 1992. Effects of 5-HT1A receptor agonists on the circadian rhythm of wheel-running activity in hamsters. *Eur J Pharmacol*, 214, 79-84.
- TRAVNICKOVA-BENDOVA, Z., CERMAKIAN, N., REPERT, S. M. & SASSONE-CORSI, P. 2002. Bimodal regulation of mPeriod promoters by CREB-dependent signaling and CLOCK/BMAL1 activity. *Proc Natl Acad Sci U S A*, 99, 7728-33.
- TRICARICO, C., PINZANI, P., BIANCHI, S., PAGLIERANI, M., DISTANTE, V., PAZZAGLI, M., BUSTIN, S. A. & ORLANDO, C. 2002. Quantitative real-time reverse transcription polymerase chain reaction: normalization to rRNA or single housekeeping genes is inappropriate for human tissue biopsies. *Anal Biochem*, 309, 293-300.
- TSENG, I. J., LIU, H. C., YUAN, R. Y., SHEU, J. J., YU, J. M. & HU, C. J. 2010. Expression of inducible nitric oxide synthase (iNOS) and period 1 (PER1)

- clock gene products in different sleep stages of patients with cognitive impairment. *J Clin Neurosci*, 17, 1140-3.
- TURNER, D. C., CLARK, L., DOWSON, J., ROBBINS, T. W. & SAHAKIAN, B. J. 2004. Modafinil improves cognition and response inhibition in adult attention-deficit/hyperactivity disorder. *Biol Psychiatry*, 55, 1031-40.
- TYRKA, A. R., WIER, L. M., PRICE, L. H., RIKHYE, K., ROSS, N. S., ANDERSON, G. M., WILKINSON, C. W. & CARPENTER, L. L. 2008. Cortisol and ACTH responses to the Dex/CRH test: influence of temperament. *Horm Behav*, 53, 518-25.
- TZISCHINSKY, O., PAL, I., EPSTEIN, R., DAGAN, Y. & LAVIE, P. 1992. The importance of timing in melatonin administration in a blind man. *J Pineal Res*, 12, 105-8.
- TZISCHINSKY, O., SHLITNER, A. & LAVIE, P. 1993. The association between the nocturnal sleep gate and nocturnal onset of urinary 6-sulfatoxymelatonin. *J Biol Rhythms*, 8, 199-209.
- UEYAMA, T., KROUT, K. E., NGUYEN, X. V., KARPITSKIY, V., KOLLERT, A., METTENLEITER, T. C. & LOEWY, A. D. 1999. Suprachiasmatic nucleus: a central autonomic clock. *Nat Neurosci*, 2, 1051-3.
- UZ, T., AHMED, R., AKHISAROGLU, M., KURTUNCU, M., IMBESI, M., DIRIM ARSLAN, A. & MANEV, H. 2005. Effect of fluoxetine and cocaine on the expression of clock genes in the mouse hippocampus and striatum. *Neuroscience*, 134, 1309-16.
- VAN CAUTER, E., LEPROULT, R. & KUPFER, D. J. 1996. Effects of gender and age on the levels and circadian rhythmicity of plasma cortisol. *J Clin Endocrinol Metab*, 81, 2468-73.
- VAN CAUTER, E., LINKOWSKI, P., KERKHOF, M., HUBAIN, P., L'HERMITE-BALERIAUX, M., LECLERCQ, R., BRASSEUR, M., COPINSCHI, G. & MENDLEWICZ, J. 1991. Circadian and sleep-related endocrine rhythms in schizophrenia. *Arch Gen Psychiatry*, 48, 348-56.
- VAN DE KAMP, J. L. & COLLINS, A. C. 1994. Prenatal nicotine alters nicotinic receptor development in the mouse brain. *Pharmacol Biochem Behav*, 47, 889-900.
- VAN DE WIEL, N. M., VAN GOOZEN, S. H., MATTHYS, W., SNOEK, H. & VAN ENGELAND, H. 2004. Cortisol and treatment effect in children with

- disruptive behavior disorders: a preliminary study. *J Am Acad Child Adolesc Psychiatry*, 43, 1011-8.
- VAN DEN BERGH, B. R., VAN CALSTER, B., PINNA PUISSANT, S. & VAN HUFFEL, S. 2008. Self-reported symptoms of depressed mood, trait anxiety and aggressive behavior in post-pubertal adolescents: Associations with diurnal cortisol profiles. *Horm Behav*, 54, 253-7.
- VAN DEN BERGH, F. S., BLOEMARTS, E., CHAN, J. S., GROENINK, L., OLIVIER, B. & OOSTING, R. S. 2006. Spontaneously hypertensive rats do not predict symptoms of attention-deficit hyperactivity disorder. *Pharmacol Biochem Behav*, 83, 380-90.
- VAN DEN POL, A. N. & DUDEK, F. E. 1993. Cellular communication in the circadian clock, the suprachiasmatic nucleus. *Neuroscience*, 56, 793-811.
- VAN DEN POL, A. N. & TSUJIMOTO, K. L. 1985. Neurotransmitters of the hypothalamic suprachiasmatic nucleus: immunocytochemical analysis of 25 neuronal antigens. *Neuroscience*, 15, 1049-86.
- VAN DER HEIJDEN, K. B., SMITS, M. G., VAN SOMEREN, E. J. & GUNNING, W. B. 2005. Idiopathic chronic sleep onset insomnia in attention-deficit/hyperactivity disorder: a circadian rhythm sleep disorder. *Chronobiol Int*, 22, 559-70.
- VAN DER HEIJDEN, K. B., SMITS, M. G., VAN SOMEREN, E. J., RIDDERINKHOF, K. R. & GUNNING, W. B. 2007. Effect of melatonin on sleep, behavior, and cognition in ADHD and chronic sleep-onset insomnia. *J Am Acad Child Adolesc Psychiatry*, 46, 233-41.
- VAN DER HORST, G. T., MUIJTJENS, M., KOBAYASHI, K., TAKANO, R., KANNO, S., TAKAO, M., DE WIT, J., VERKERK, A., EKER, A. P., VAN LEENEN, D., BUIJS, R., BOOTSMA, D., HOEIJMAKERS, J. H. & YASUI, A. 1999. Mammalian Cry1 and Cry2 are essential for maintenance of circadian rhythms. *Nature*, 398, 627-30.
- VAN GOOZEN, S. H., MATTHYS, W., COHEN-KETTENIS, P. T., BUITELAAR, J. K. & VAN ENGELAND, H. 2000. Hypothalamic-pituitary-adrenal axis and autonomic nervous system activity in disruptive children and matched controls. *J Am Acad Child Adolesc Psychiatry*, 39, 1438-45.
- VAN REETH, O., WEIBEL, L., OLIVARES, E., MACCARI, S., MOCAER, E. & TUREK, F. W. 2001. Melatonin or a melatonin agonist corrects age-related

- changes in circadian response to environmental stimulus. *Am J Physiol Regul Integr Comp Physiol*, 280, R1582-91.
- VAN SOMEREN, E. J. & RIEMERSMA-VAN DER LEK, R. F. 2007. Live to the rhythm, slave to the rhythm. *Sleep Med Rev*, 11, 465-84.
- VAN SOMEREN, E.J., SWAAB, D.F., COLEND, C.C., COHEN, W., MCCALL W.V. & ROSENQUIST, P.B. 1999. Bright light therapy: improved sensitivity to its effects on rest-activity rhythms in Alzheimer patients by application of nonparametric methods. *Chronobiol Int*, 16, 505-18.
- VAN VEEN, M. M., KOOIJ, J. J., BOONSTRA, A. M., GORDIJN, M. C. & VAN SOMEREN, E. J. 2010. Delayed circadian rhythm in adults with attention-deficit/hyperactivity disorder and chronic sleep-onset insomnia. *Biol Psychiatry*, 67, 1091-6.
- VAN WEST, D., CLAES, S. & DEBOUTTE, D. 2009. Differences in hypothalamic-pituitary-adrenal axis functioning among children with ADHD predominantly inattentive and combined types. *Eur Child Adolesc Psychiatry*.
- VANDESANDE, F., DIERICKX, K. & DEMEY, J. 1975. Identification of the vasopressin-neurophysin producing neurons of the rat suprachiasmatic nuclei. *Cell Tissue Res*, 156, 377-80.
- VANDEWALLE, G., ARCHER, S. N., WUILLAUME, C., BALTEAU, E., DEGUELDRE, C., LUXEN, A., MAQUET, P. & DIJK, D. J. 2009. Functional magnetic resonance imaging-assessed brain responses during an executive task depend on interaction of sleep homeostasis, circadian phase, and PER3 genotype. *J Neurosci*, 29, 7948-56.
- VARCOE, T. J. & KENNAWAY, D. J. 2008. Activation of 5-HT_{2C} receptors acutely induces Per1 gene expression in the rat SCN in vitro. *Brain Res*, 1209, 19-28.
- VIGGIANO, D., VALLONE, D. & SADILE, A. 2004. Dysfunctions in dopamine systems and ADHD: evidence from animals and modeling. *Neural Plast*, 11, 97-114.
- VIOLA, A. U., ARCHER, S. N., JAMES, L. M., GROEGER, J. A., LO, J. C., SKENE, D. J., VON SCHANTZ, M. & DIJK, D. J. 2007. PER3 polymorphism predicts sleep structure and waking performance. *Curr Biol*, 17, 613-8.

- VIRKKUNEN, M. 1985. Urinary free cortisol secretion in habitually violent offenders. *Acta Psychiatr Scand*, 72, 40-4.
- VITATERNA, M. H., KO, C. H., CHANG, A. M., BUHR, E. D., FRUECHTE, E. M., SCHOOK, A., ANTOCH, M. P., TUREK, F. W. & TAKAHASHI, J. S. 2006. The mouse Clock mutation reduces circadian pacemaker amplitude and enhances efficacy of resetting stimuli and phase-response curve amplitude. *Proc Natl Acad Sci U S A*, 103, 9327-32.
- VITATERNA, M. H., SELBY, C. P., TODO, T., NIWA, H., THOMPSON, C., FRUECHTE, E. M., HITOMI, K., THRESHER, R. J., ISHIKAWA, T., MIYAZAKI, J., TAKAHASHI, J. S. & SANCAR, A. 1999. Differential regulation of mammalian period genes and circadian rhythmicity by cryptochromes 1 and 2. *Proc Natl Acad Sci U S A*, 96, 12114-9.
- VLES, J. S., FERON, F. J., HENDRIKSEN, J. G., JOLLES, J., VAN KROONENBURGH, M. J. & WEBER, W. E. 2003. Methylphenidate down-regulates the dopamine receptor and transporter system in children with attention deficit hyperkinetic disorder (ADHD). *Neuropediatrics*, 34, 77-80.
- VODERHOLZER, U., WESKE, G., ECKER, S., RIEMANN, D., GANN, H. & BERGER, M. 2002. Neurobiological findings before and during successful lithium therapy of a patient with 48-hour rapid-cycling bipolar disorder. *Neuropsychobiology*, 45 Suppl 1, 13-9.
- VOLKOW, N. D. & SWANSON, J. M. 2003. Variables that affect the clinical use and abuse of methylphenidate in the treatment of ADHD. *Am J Psychiatry*, 160, 1909-18.
- VOLKOW, N. D., WANG, G. J., FOWLER, J. S., GATLEY, S. J., LOGAN, J., DING, Y. S., HITZEMANN, R. & PAPPAS, N. 1998. Dopamine transporter occupancies in the human brain induced by therapeutic doses of oral methylphenidate. *Am J Psychiatry*, 155, 1325-31.
- VOLKOW, N. D., WANG, G. J., NEWCORN, J. H., KOLLINS, S. H., WIGAL, T. L., TELANG, F., FOWLER, J. S., GOLDSTEIN, R. Z., KLEIN, N., LOGAN, J., WONG, C. & SWANSON, J. M. 2010. Motivation deficit in ADHD is associated with dysfunction of the dopamine reward pathway. *Mol Psychiatry*.
- VON GALL, C., SCHNEIDER-HUTHER, I., PFEFFER, M., DEHGHANI, F., KORF, H. W. & STEHLE, J. H. 2001. Clock gene protein mPER1 is

- rhythmically synthesized and under cAMP control in the mouse pineal organ. *J Neuroendocrinol*, 13, 313-6.
- VON SCHANTZ, M. 2008. Phenotypic effects of genetic variability in human clock genes on circadian and sleep parameters. *J Genet*, 87, 513-9.
- VRANG, N., LARSEN, P. J., MOLLER, M. & MIKKELSEN, J. D. 1995. Topographical organization of the rat suprachiasmatic-paraventricular projection. *J Comp Neurol*, 353, 585-603.
- WAGNER, S., CASTEL, M., GAINER, H. & YAROM, Y. 1997. GABA in the mammalian suprachiasmatic nucleus and its role in diurnal rhythmicity. *Nature*, 387, 598-603.
- WAKAMATSU, H., YOSHINOBU, Y., AIDA, R., MORIYA, T., AKIYAMA, M. & SHIBATA, S. 2001. Restricted-feeding-induced anticipatory activity rhythm is associated with a phase-shift of the expression of mPer1 and mPer2 mRNA in the cerebral cortex and hippocampus but not in the suprachiasmatic nucleus of mice. *Eur J Neurosci*, 13, 1190-6.
- WALDHAUSER, F., EHRHART, B. & FORSTER, E. 1993. Clinical aspects of the melatonin action: impact of development, aging, and puberty, involvement of melatonin in psychiatric disease and importance of neuroimmunoendocrine interactions. *Experientia*, 49, 671-81.
- WALL, S. J. & EDWARDS, D. R. 2002. Quantitative reverse transcription-polymerase chain reaction (RT-PCR): a comparison of primer-dropping, competitive, and real-time RT-PCRs. *Anal Biochem*, 300, 269-73.
- WANG, H., KO, C. H., KOLETAR, M. M., RALPH, M. R. & YEOMANS, J. 2007. Casein kinase I epsilon gene transfer into the suprachiasmatic nucleus via electroporation lengthens circadian periods of tau mutant hamsters. *Eur J Neurosci*, 25, 3359-66.
- WANG, J., YIN, L. & LAZAR, M. A. 2006. The orphan nuclear receptor Rev-erb alpha regulates circadian expression of plasminogen activator inhibitor type 1. *J Biol Chem*, 281, 33842-8.
- WANG, L. M., DRAGICH, J. M., KUDO, T., ODOM, I. H., WELSH, D. K., O'DELL, T. J. & COLWELL, C. S. 2009. Expression of the circadian clock gene Period2 in the hippocampus: possible implications for synaptic plasticity and learned behaviour. *ASN Neuro*, 1.

- WARBURTON, G., NARES, S., ANGELOV, N., BRAHIM, J. S., DIONNE, R. A. & WAHL, S. M. 2005. Transcriptional events in a clinical model of oral mucosal tissue injury and repair. *Wound Repair Regen*, 13, 19-26.
- WATANABE, Y., FUJITA, M., ITO, Y., OKADA, T., KUSUOKA, H. & NISHIMURA, T. 1997. Brain dopamine transporter in spontaneously hypertensive rats. *J Nucl Med*, 38, 470-4.
- WEAFER, J., MILICH, R. & FILLMORE, M. T. 2010. Behavioral components of impulsivity predict alcohol consumption in adults with ADHD and healthy controls. *Drug Alcohol Depend*.
- WEBER, E. T., GANNON, R. L., MICHEL, A. M., GILLETTE, M. U. & REA, M. A. 1995. Nitric oxide synthase inhibitor blocks light-induced phase shifts of the circadian activity rhythm, but not c-fos expression in the suprachiasmatic nucleus of the Syrian hamster. *Brain Res*, 692, 137-42.
- WEBER, M., LAUTERBURG, T., TOBLER, I. & BURGUNDER, J. M. 2004. Circadian patterns of neurotransmitter related gene expression in motor regions of the rat brain. *Neurosci Lett*, 358, 17-20.
- WEHR, T. A. 1989. Sleep loss: a preventable cause of mania and other excited states. *J Clin Psychiatry*, 50 Suppl, 8-16; discussion 45-7.
- WEHR, T. A., DUNCAN, W. C., JR., SHER, L., AESCHBACH, D., SCHWARTZ, P. J., TURNER, E. H., POSTOLACHE, T. T. & ROSENTHAL, N. E. 2001. A circadian signal of change of season in patients with seasonal affective disorder. *Arch Gen Psychiatry*, 58, 1108-14.
- WEHR, T. A., SACK, D., ROSENTHAL, N., DUNCAN, W. & GILLIN, J. C. 1983. Circadian rhythm disturbances in manic-depressive illness. *Fed Proc*, 42, 2809-14.
- WEHR, T. A., WIRZ-JUSTICE, A., GOODWIN, F. K., DUNCAN, W. & GILLIN, J. C. 1979. Phase advance of the circadian sleep-wake cycle as an antidepressant. *Science*, 206, 710-3.
- WESTERINK, B. H. 1995. Brain microdialysis and its application for the study of animal behaviour. *Behav Brain Res*, 70, 103-24.
- WESTGARD, J. O. & DARCY, T. 2004. The truth about quality: medical usefulness and analytical reliability of laboratory tests. *Clin Chim Acta*, 346, 3-11.
- WESTRIN, A. & LAM, R. W. 2007. Seasonal affective disorder: a clinical update. *Ann Clin Psychiatry*, 19, 239-46.

- WHITE, B. P. & MULLIGAN, S. E. 2005. Behavioral and physiologic response measures of occupational task performance: a preliminary comparison between typical children and children with attention disorder. *Am J Occup Ther*, 59, 426-36.
- WIECHMANN, A. F. & SUMMERS, J. A. 2008. Circadian rhythms in the eye: the physiological significance of melatonin receptors in ocular tissues. *Prog Retin Eye Res*, 27, 137-60.
- WIERSEMA, J. R., VAN DER MEERE, J. J. & ROEYERS, H. 2005. ERP correlates of impaired error monitoring in children with ADHD. *J Neural Transm*, 112, 1417-30.
- WIGGS, L. & STORES, G. 2004. Sleep patterns and sleep disorders in children with autistic spectrum disorders: insights using parent report and actigraphy. *Dev Med Child Neurol*, 46, 372-80.
- WILENS, T. E., ADLER, L. A., WEISS, M. D., MICHELSON, D., RAMSEY, J. L., MOORE, R. J., RENARD, D., BRADY, K. T., TRZEPACZ, P. T., SCHUH, L. M., AHRBECKER, L. M. & LEVINE, L. R. 2008. Atomoxetine treatment of adults with ADHD and comorbid alcohol use disorders. *Drug Alcohol Depend*, 96, 145-54.
- WILENS, T. E., FARAONE, S. V., BIEDERMAN, J. & GUNAWARDENE, S. 2003a. Does stimulant therapy of attention-deficit/hyperactivity disorder beget later substance abuse? A meta-analytic review of the literature. *Pediatrics*, 111, 179-85.
- WILENS, T. E., PRINCE, J. B., SPENCER, T., VAN PATTEN, S. L., DOYLE, R., GIRARD, K., HAMMERNESS, P., GOLDMAN, S., BROWN, S. & BIEDERMAN, J. 2003b. An open trial of bupropion for the treatment of adults with attention-deficit/hyperactivity disorder and bipolar disorder. *Biol Psychiatry*, 54, 9-16.
- WILKINS, A. K., BARTON, P. I. & TIDOR, B. 2007. The Per2 negative feedback loop sets the period in the mammalian circadian clock mechanism. *PLoS Comput Biol*, 3, e242.
- WILLCUTT, E. G., DOYLE, A. E., NIGG, J. T., FARAONE, S. V. & PENNINGTON, B. F. 2005. Validity of the executive function theory of attention-deficit/hyperactivity disorder: a meta-analytic review. *Biol Psychiatry*, 57, 1336-46.

- WILLCUTT, E. G., PENNINGTON, B. F., CHHABILDAS, N. A., FRIEDMAN, M. C. & ALEXANDER, J. 1999. Psychiatric comorbidity associated with DSM-IV ADHD in a nonreferred sample of twins. *J Am Acad Child Adolesc Psychiatry*, 38, 1355-62.
- WILLCUTT, E. G., PENNINGTON, B. F. & DEFRIES, J. C. 2000. Etiology of inattention and hyperactivity/impulsivity in a community sample of twins with learning difficulties. *J Abnorm Child Psychol*, 28, 149-59.
- WILSON, M. C. 2000. Coloboma mouse mutant as an animal model of hyperkinesia and attention deficit hyperactivity disorder. *Neurosci Biobehav Rev*, 24, 51-7.
- WIRZ-JUSTICE, A., BENEDETTI, F., BERGER, M., LAM, R. W., MARTINY, K., TERMAN, M. & WU, J. C. 2005. Chronotherapeutics (light and wake therapy) in affective disorders. *Psychol Med*, 35, 939-44.
- WISE, R. A. 1998. Drug-activation of brain reward pathways. *Drug Alcohol Depend*, 51, 13-22.
- WISE, R. A. 2004. Dopamine, learning and motivation. *Nat Rev Neurosci*, 5, 483-94.
- WITKOVSKY, P. 2004. Dopamine and retinal function. *Doc Ophthalmol*, 108, 17-40.
- WONGCHITRAT, P., FELDER-SCHMITTBUHL, M. P., PHANSUWAN-PUJITO, P., PEVET, P. & SIMONNEAUX, V. 2009. Endogenous rhythmicity of Bmal1 and Rev-erb alpha in the hamster pineal gland is not driven by norepinephrine. *Eur J Neurosci*, 29, 2009-16.
- WRIGHT, K. P., JR., HULL, J. T., HUGHES, R. J., RONDA, J. M. & CZEISLER, C. A. 2006. Sleep and wakefulness out of phase with internal biological time impairs learning in humans. *J Cogn Neurosci*, 18, 508-21.
- WU, J. C. & BUNNEY, W. E. 1990. The biological basis of an antidepressant response to sleep deprivation and relapse: review and hypothesis. *Am J Psychiatry*, 147, 14-21.
- WU, Y. H., FISCHER, D. F., KALSBECK, A., GARIDOU-BOOF, M. L., VAN DER VLIET, J., VAN HEIJNINGEN, C., LIU, R. Y., ZHOU, J. N. & SWAAB, D. F. 2006. Pineal clock gene oscillation is disturbed in Alzheimer's disease, due to functional disconnection from the "master clock". *FASEB J*, 20, 1874-6.
- WULFF, K., JOYCE, E., MIDDLETON, B., DIJK, D. J. & FOSTER, R. G. 2006. The suitability of actigraphy, diary data, and urinary melatonin profiles for

- quantitative assessment of sleep disturbances in schizophrenia: a case report. *Chronobiol Int*, 23, 485-95.
- WYSE, C. A. & COOGAN, A. N. 2010. Impact of aging on diurnal expression patterns of CLOCK and BMAL1 in the mouse brain. *Brain Res*, 1337, 21-31.
- XU, X., BREEN, G., CHEN, C. K., HUANG, Y. S., WU, Y. Y. & ASHERSON, P. 2010. Association study between a polymorphism at the 3'-untranslated region of CLOCK gene and attention deficit hyperactivity disorder. *Behav Brain Funct*, 6, 48.
- XU, Y., PADIATH, Q. S., SHAPIRO, R. E., JONES, C. R., WU, S. C., SAIGOH, N., SAIGOH, K., PTACEK, L. J. & FU, Y. H. 2005. Functional consequences of a CK1delta mutation causing familial advanced sleep phase syndrome. *Nature*, 434, 640-4.
- YAGITA, K. & OKAMURA, H. 2000. Forskolin induces circadian gene expression of rPer1, rPer2 and dbp in mammalian rat-1 fibroblasts. *FEBS letters*, 465, 79-82.
- YAMAGUCHI, S., ISEJIMA, H., MATSUO, T., OKURA, R., YAGITA, K., KOBAYASHI, M. & OKAMURA, H. 2003. Synchronization of cellular clocks in the suprachiasmatic nucleus. *Science*, 302, 1408-12.
- YAMAGUCHI, S., MITSUI, S., MIYAKE, S., YAN, L., ONISHI, H., YAGITA, K., SUZUKI, M., SHIBATA, S., KOBAYASHI, M. & OKAMURA, H. 2000a. The 5' upstream region of mPer1 gene contains two promoters and is responsible for circadian oscillation. *Curr Biol*, 10, 873-6.
- YAMAGUCHI, S., MITSUI, S., YAN, L., YAGITA, K., MIYAKE, S. & OKAMURA, H. 2000b. Role of DBP in the circadian oscillatory mechanism. *Molecular and cellular biology*, 20, 4773-81.
- YAMAMOTO, H., IMAI, K., TAKAMATSU, Y., KAMEGAYA, E., KISHIDA, M., HAGINO, Y., HARA, Y., SHIMADA, K., YAMAMOTO, T., SORA, I., KOGA, H. & IKEDA, K. 2005. Methamphetamine modulation of gene expression in the brain: analysis using customized cDNA microarray system with the mouse homologues of KIAA genes. *Brain Res Mol Brain Res*, 137, 40-6.
- YAN, Z., FENG, J., FIENBERG, A. A. & GREENGARD, P. 1999. D(2) dopamine receptors induce mitogen-activated protein kinase and cAMP response

- element-binding protein phosphorylation in neurons. *Proceedings of the National Academy of Sciences of the United States of America*, 96, 11607-12.
- YANG, L., WANG, Y. F., LI, J. & FARAONE, S. V. 2004. Association of norepinephrine transporter gene with methylphenidate response. *J Am Acad Child Adolesc Psychiatry*, 43, 1154-8.
- YANG, S., VAN DONGEN, H. P., WANG, K., BERRETTINI, W. & BUCAN, M. 2009. Assessment of circadian function in fibroblasts of patients with bipolar disorder. *Mol Psychiatry*, 14, 143-55.
- YANG, S. J., SHIN, D. W., NOH, K. S. & STEIN, M. A. 2007. Cortisol is inversely correlated with aggression for those boys with attention deficit hyperactivity disorder who retain their reactivity to stress. *Psychiatry Res*, 153, 55-60.
- YANG, W., FRIEDMAN, P. A., KUMAR, R., OMDAHL, J. L., MAY, B. K., SIU-CALDERA, M. L., REDDY, G. S. & CHRISTAKOS, S. 1999. Expression of 25(OH)D3 24-hydroxylase in distal nephron: coordinate regulation by 1,25(OH)2D3 and cAMP or PTH. *The American journal of physiology*, 276, E793-805.
- YANG, Z. & DICKMAN, M. B. 1999a. Colletotrichum trifolii mutants disrupted in the catalytic subunit of cAMP-dependent protein kinase are nonpathogenic. *Molecular plant-microbe interactions : MPMI*, 12, 430-9.
- YANG, Z. & DICKMAN, M. B. 1999b. Molecular cloning and characterization of Ct-PKAR, a gene encoding the regulatory subunit of cAMP-dependent protein kinase in Colletotrichum trifolii. *Archives of microbiology*, 171, 249-56.
- YANO, M. & STEINER, H. 2005a. Methylphenidate (Ritalin) induces Homer 1a and zif 268 expression in specific corticostriatal circuits. *Neuroscience*, 132, 855-65.
- YANO, M. & STEINER, H. 2005b. Topography of methylphenidate (ritalin)-induced gene regulation in the striatum: differential effects on c-fos, substance P and opioid peptides. *Neuropsychopharmacology*, 30, 901-15.
- YANO, M. & STEINER, H. 2007. Methylphenidate and cocaine: the same effects on gene regulation? *Trends Pharmacol Sci*, 28, 588-96.
- YEHUDA, R., TEICHER, M. H., TRESTMAN, R. L., LEVENGOOD, R. A. & SIEVER, L. J. 1996. Cortisol regulation in posttraumatic stress disorder and major depression: a chronobiological analysis. *Biol Psychiatry*, 40, 79-88.

- YIN, L., WANG, J., KLEIN, P. S. & LAZAR, M. A. 2006. Nuclear receptor Rev-erbalpha is a critical lithium-sensitive component of the circadian clock. *Science*, 311, 1002-5.
- YING, S. W. & RUSAK, B. 1994. Effects of serotonergic agonists on firing rates of photically responsive cells in the hamster suprachiasmatic nucleus. *Brain Res*, 651, 37-46.
- YING, S. W., RUSAK, B., DELAGRANGE, P., MOCAER, E., RENARD, P. & GUARDIOLA-LEMAITRE, B. 1996. Melatonin analogues as agonists and antagonists in the circadian system and other brain areas. *Eur J Pharmacol*, 296, 33-42.
- YOON, S. O. & CHIKARAISHI, D. M. 1994. Isolation of two E-box binding factors that interact with the rat tyrosine hydroxylase enhancer. *J Biol Chem*, 269, 18453-62.
- YOUNG, E. A., LOPEZ, J. F., MURPHY-WEINBERG, V., WATSON, S. J. & AKIL, H. 2003. Mineralocorticoid receptor function in major depression. *Arch Gen Psychiatry*, 60, 24-8.
- YUJNOVSKY, I., HIRAYAMA, J., DOI, M., BORRELLI, E. & SASSONE-CORSI, P. 2006. Signaling mediated by the dopamine D2 receptor potentiates circadian regulation by CLOCK:BMAL1. *Proc Natl Acad Sci U S A*, 103, 6386-91.
- ZANQUETTA, M. M., CORREA-GIANNELLA, M. L., MONTEIRO, M. B. & VILLARES, S. M. 2010. Body weight, metabolism and clock genes. *Diabetol Metab Syndr*, 2, 53.
- ZHDANOVA, I. V. & TUCCI, V. 2003. Melatonin, Circadian Rhythms, and Sleep. *Curr Treat Options Neurol*, 5, 225-229.
- ZHDANOVA, I. V., WURTMAN, R. J., MORABITO, C., PIOTROVSKA, V. R. & LYNCH, H. J. 1996. Effects of low oral doses of melatonin, given 2-4 hours before habitual bedtime, on sleep in normal young humans. *Sleep*, 19, 423-31.
- ZHENG, B., LARKIN, D. W., ALBRECHT, U., SUN, Z. S., SAGE, M., EICHELE, G., LEE, C. C. & BRADLEY, A. 1999. The mPer2 gene encodes a functional component of the mammalian circadian clock. *Nature*, 400, 169-73.
- ZHU, G., CHANG, Y., ZUO, J., DONG, X., ZHANG, M., HU, G. & FANG, F. 2001. Fudenine, a C-terminal truncated rat homologue of mouse prominin, is

blood glucose-regulated and can up-regulate the expression of GAPDH.

Biochem Biophys Res Commun, 281, 951-6.

ZYLKA, M. J., SHEARMAN, L. P., WEAVER, D. R. & REPERT, S. M. 1998.

Three period homologs in mammals: differential light responses in the suprachiasmatic circadian clock and oscillating transcripts outside of brain.

Neuron, 20, 1103-10.